

GEOLOGY

The
University
of Iowa
Libraries

v. 14
1903
cop. 6

THE UNIVERSITY
OF IOWA LIBRARIES
WITHDRAWN
57



ARY
S
57

Geology

UNIVERSITY OF IOWA
LIBRARIES
THE UNIVERSITY
OF IOWA LIBRARIES
WITHDRAWN

IOWA

GEOLOGICAL SURVEY

VOLUME XIV

ANNUAL REPORT, 1903

WITH

ACCOMPANYING PAPERS

SAMUEL CALVIN, A. M., PH. D., STATE GEOLOGIST

T. E. SAVAGE, ASSISTANT STATE GEOLOGIST



DES MOINES
PUBLISHED FOR IOWA GEOLOGICAL SURVEY
1904

DES MOINES:

BERNARD MURPHY, STATE PRINTER

1904

Geology
557.77
I6.1
v. 14
1903
Cop. 6

GEOLOGICAL BOARD.

HIS EXCELLENCY, A. B. CUMMINS GOVERNOR OF IOWA
HON. B. F. CARROLL AUDITOR OF STATE
DR. GEO. E. MACLEAN PRES. STATE UNIVERSITY OF IOWA
DR. A. B. STORMS PRES. IOWA STATE COLLEGE
PROF. B. SHIMEK PRES. IOWA ACADEMY OF SCIENCES



GEOLOGICAL CORPS.

SAMUEL CALVIN STATE GEOLOGIST
T. E. SAVAGE ASSISTANT STATE GEOLOGIST

J. B. WEEMS..... CHEMIST
S. W. BEYER SPECIAL ASSISTANT
W. H. NORTON..... SPECIAL ASSISTANT
J. A. UDDEN ... SPECIAL ASSISTANT
T. H. MACBRIDE SPECIAL ASSISTANT
F. A. WILDER..... SPECIAL ASSISTANT
IRA A. WILLIAMS SPECIAL ASSISTANT
NELLIE E. NEWMAN..... SECRETARY

CONTENTS.

| | PAGE |
|---|------|
| MEMBERS OF GEOLOGICAL BOARD | iii |
| GEOLOGICAL CORPS | iv |
| TABLE OF CONTENTS..... | v |
| LIST OF ILLUSTRATIONS..... | vii |
| ADMINISTRATIVE REPORT | 3 |
| STATISTICS OF MINERAL PRODUCTION..... | 9 |
| TECHNOLOGY OF CLAYS | 29 |
| CHEMISTRY OF CLAYS ... | 319 |
| SELECTION, INSTALLATION AND CARE OF POWER PLANTS..... | 347 |
| GEOLOGY OF CLAYS..... | 377 |
| TESTS OF CLAY PRODUCTS | 555 |
| DIRECTORY OF CLAY WORKERS | 621 |
| ACKNOWLEDGMENTS | 642 |
| MINERAL STATISTICS FOR 1903..... | 645 |

LIST OF ILLUSTRATIONS.

PLATES.

- I. Map showing progress of detailed mapping.
- II. Geological map of Iowa.
- III. Map of the drift sheets of Iowa.
- IV. Standard nine-foot dry pan with steel frame.
- V. Vertical type of soft mud brick machine.
- VI. Vertical type of mold brick machine.
- VII. Type of the automatic rotary side cutter. Horizontal type of stiff mud brick machine and automatic sander.
- VIII. Automatic oscillating reciprocal down cut table.
- IX. The Richardson repress. Front and back views.
- X. The Eagle double die brick repress. Front view.
- XI. Domeless boiler with nozzles, shell extended.
- XII. Method of hanging a shell boiler.
- XIII. Setting for one 72-inch horizontal tubular boiler with oven furnace.
- XIV. Setting for one 72-inch horizontal tubular boiler.
- XV. Type of simple, direct acting boiler feed pump, in section.
- XVI. Shale pit of Mason City Brick and Tile Company, Mason City, Iowa.
- XVII. Plant of the Mason City Brick and Tile Company.
- XVIII. Pit of the Granite Brick Company.
- XIX. Pit of the Centerville Brick and Tile Company.
- XX. Pit of the Boone Brick and Tile Company.
- XXI. Section on Gray creek, Pleasant township, Monroe county.
- XXII. Section of the upper Coal Measures, Stennett, Montgomery county.
- XXIII. Present pit of the Flint Brick Company, Des Moines, Iowa.
- XXIV. Plant of the Flint Brick Company, Des Moines, Iowa.
- XXV. A modern rotary cutting table used by the Iowa Brick Company, Des Moines, Iowa.
- XXVI. Plant of the Des Moines Brick and Tile Company, Des Moines, Iowa.
- XXVII. A portion of the plant of the Ottumwa Brick and Construction Company, Ottumwa, Iowa.
- XXVIII. Pit of the Lehigh Brick and Tile Company, Lehigh, Iowa.
- XXIX. Plant of the Lehigh Brick and Tile Company, Lehigh, Iowa.

PLATES.

- XXX. Reel cutting table for hollow ware, Lehigh Brick and Tile Company, Lehigh, Iowa.
- XXXI. (a) Dry press shape machine. (b) Method of facing dry press brick in a round, down draft kiln, Corey Pressed Brick and Coal Company, Lehigh, Iowa.
- XXXII. Pit of the Campbell Brick and Tile Company, Lehigh, Iowa.
- XXXIII. Pit of the Sioux City Brick and Tile Company, North Riverside, Sioux City, Iowa.
- XXXIV. Plant of the Sioux City Brick and Tile Company, North Riverside, Sioux City, Iowa.
- XXXV. Interior view of Haigh continuous kiln, showing method of setting hollow ware, Sioux City Brick and Tile Company, Sioux City, Iowa.
- XXXVI. Plant near Moravia, Iowa, showing method of manufacturing surface clays.
- XXXVII. Clay pit of the Kelly Brick and Tile Works.
- XXXVIII. Plate showing comparative results of freezing tests on brick and stone.

FIGURES.

1. Fairbanks machine used in measuring the tensile strength of clays.
2. The Seger Volumeter.
3. Hoskins furnace with Le Chatelier's pyrometer for making fusibility tests on clays.
4. Automatic clay gatherer, adapted to yards using surface clays.
5. Side-dumping clay car.
6. End-dumping clay car.
7. Sectional view of the jaw type of rock crusher.
8. Clay crusher, corrugated rolls type.
9. Clay crusher, corrugated rolls with automatic relief feeder.
10. Clay disintegrator and pulverizer of the Steadman type.
11. Williams disintegrator and pulverizer.
12. Rotary type of clay screen.
13. Type of revolving clay screen with automatic brush cleaner.
14. Soaking pit and wooden pug mill. Carl Hagemester, Muscatine, Iowa.
15. Common brick mold for soft mud brick.
16. Ring Pit. Carl Hagemester, Muscatine, Iowa.
17. Horizontal type of soft mud brick machine.
18. Horizontal type of soft mud brick machine.
19. Vertical type of stiff mud brick and tile machine.
20. The automatic indenting brick cutter.
21. Sectional views of Reciprocating Oscillating side cut table.
22. Modern four-mold dry press.
23. Open air drying, Samuels brickyard, Muscatine, Iowa.

FIGURES.

24. Cast iron flat car with pallets.
25. Double deck steel car.
26. Combination transfer car and turntable.
27. Floor plan, Multiple stack, round down draft kiln.
28. Round down draft kiln with two stacks.
29. Rectangular down draft kiln with stacks at the ends.
30. Interior of rectangular down draft kiln showing method of facing dry pressed brick.
31. Boiler with dome shell extended for full front. Wrought iron hangers.
32. Domeless boiler with nozzles. Shell extended for full front.
33. A good type of rocking grate.
34. Type of boiler feed pump; Duplex.
35. Duplex pump in section.
36. Feed-water heater.
37. Feed-water heater in section.
38. Type of open feed-water heater.
39. Sectional view of open feed-water heater.
40. Type of closed feed-water heater.
41. Section near Edgewood, showing over sixty feet of Maquoketa shales.
42. Maquoketa shales west of Graf.
43. Characteristic topography of the Maquoketa shales, near Graf.
44. Plant of American Brick and Tile Company.
45. Plant of the Granite Brick Company.
46. Pit of the Boone Clay Works.
47. Plant of the Boone Clay Works.
48. Plant of the Platt Pressed and Fire Brick Company, Van Meter, Iowa.
49. Plant of Webster City Brick and Tile Company.
50. Honestone Quarries showing Coal Measure shales, on the Iowa river, west of Iowa Falls.
51. Raney Brothers Brick and Tile Plant.
52. Pit of the Iowa Brick Company, Des Moines, Iowa.
53. A portion of the plant of the Iowa Brick Company.
54. Represses used by the old Iowa Brick Plant, Des Moines, Iowa.
55. Pit of the Merrill Brick Company, Des Moines, Iowa.
56. A portion of the plant of the Merrill Brick Company, Des Moines, Iowa.
57. Clay pit of the Davenport Brick and Paving Company, Buffalo, Iowa.
58. Plant of the Davenport Brick and Paving Company, Buffalo, Iowa.
59. Plant of the Le Claire Brick and Tile Company, Island City, Iowa.
60. Pit of the Ottumwa Brick and Construction Company, Ottumwa, Iowa.
61. Compartment continuous kiln, modified "Dunn" pattern, Ottumwa Brick and Construction Company, Ottumwa, Iowa.
62. Modified Dunn continuous kiln in process of construction, Ottumwa Brick and Construction Company, Ottumwa, Iowa.
63. Two of the Fort Dodge brick plants—Fort Dodge Brick and Tile Company and the Fort Dodge Clay Works.

FIGURES.

64. A portion of the plant of the Fort Dodge Stoneware Company, Fort Dodge, Iowa.
65. Plant of the Kalo Brick and Tile Company, Kalo, Iowa.
66. Boyd four mold, dry press machine.
67. Plant of the Campbell Brick and Tile Company, Lehigh, Iowa.
68. Clay shales with concretions of clay-ironstone, Pottawattamie county, Iowa.
69. Benton shales exposed in railroad cut three miles south of Hawarden, in Sioux county, Iowa.
70. Pit of Holman and Brother Brick Plant, Sargents Bluff, Iowa.
71. Interior view of machinery building, Holman and Brother Brick Plant, Sargents Bluff, Iowa.
72. Interior view of Haigh continuous kiln showing method of setting brick.
73. Top view of Haigh continuous kiln showing arrangement of fire holes and open court.
74. Pit of the Muscatine Pressed Brick Company.
75. Brick machine used in the manufacture of soft mud brick.
76. Machine used by the Davy Burnt Clay Ballast Company.
77. Coaling machine used by the Davy Burnt Clay Ballast Company.
78. Stratified loess in clay pit of Seig & Size.
79. Loess occurring over stratified drift in the pit of the Le Mars Brick and Tile Company.
80. Pit of C. B. Bently and Sons, near Tama, Iowa.
81. Plant of Gethmann Brothers Pressed Brick Company.
82. Diagram showing results of compression tests.
83. Diagram showing results of transverse tests.
84. Diagram showing results of absorption tests.
85. Diagram showing per cent of absorption of brick tested.
86. Diagram showing results of freezing tests.
87. Diagram showing comparative loss on a varying number of freezings.
88. Diagram showing results of transverse and freezing tests.
89. Diagram showing comparative results of the different tests.
90. Transverse tests, Council Bluffs brick.
91. Transverse tests, Webster City brick.
92. Transverse tests, Des Moines brick.
93. Transverse tests, Mason City Brick.
94. Absorption tests, Council Bluffs brick.
95. Absorption tests, Webster City brick.
96. Absorption tests, Grand Junction brick.
97. Absorption tests, Des Moines brick.
98. Absorption tests, Mason City brick.
99. Absorption tests, Kelly brick.
100. Absorption tests, Ames hand made brick.
101. Comprehensive diagram of results of tests on Council Bluffs brick.
102. Results of tests, Webster City brick.

FIGURES.

103. Freezing tests, Goodwin brick.
104. Comprehensive diagram, Grand Junction brick.
105. Comprehensive diagram, Mason City brick.
106. Comprehensive diagram, Council Bluffs brick.
107. Comprehensive diagram, Webster City brick.
108. Comprehensive diagram, Goodwin brick.
109. Comprehensive diagram, Grand Junction brick.
110. Results of tests, Kelly brick.
111. Results of tests, Ames hand made brick.
112. Diagram showing comparative results of tests.
113. Diagram of comparative results.
114. Diagram of comparative results.
115. Crushing tests, Boone brick.
116. Crushing tests, Burlington brick.
117. Crushing tests, Capital City brick.
118. Crushing tests, Flint brick.
119. Crushing tests, Iowa brick.
120. Crushing tests, Merrill brick.
121. Transverse tests, Boone brick.
122. Transverse tests, Burlington brick.
123. Transverse tests, Capital City brick.
124. Transverse tests, Flint brick.
125. Transverse tests, Iowa brick.
126. Transverse tests, Merrill brick.
127. Rattler and absorption tests, Boone brick.
128. Rattler and absorption tests, Burlington brick.
129. Rattler and absorption tests, Capital City brick.
130. Rattler and absorption tests, Flint brick.
131. Rattler and absorption tests, Iowa brick.
132. Rattler and absorption tests, Merrill brick.



ADMINISTRATIVE REPORT.

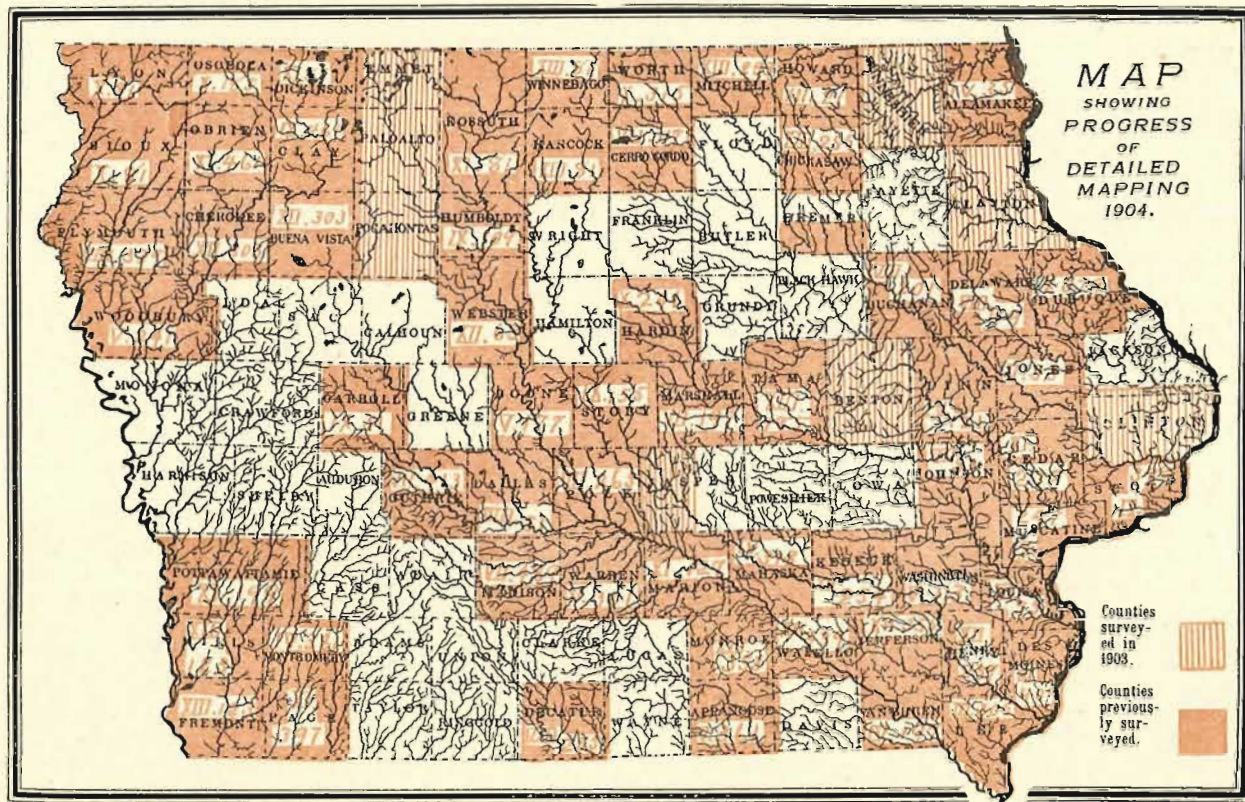

This side

faces p. 3

v. 14 cap 6

TWELFTH ANNUAL

Report of the State Geologist.

IOWA GEOLOGICAL SURVEY,
DES MOINES, DECEMBER 31, 1903.

To Governor Albert B. Cummins and Members of the Geological Board:

GENTLEMEN: I have the honor to report that the Iowa Geological Survey, in accordance with the plans approved by you at the beginning of the working season, has continued its investigation of the geology and geological resources of the state during the year 1903. One year ago Doctor Beyer's report on the Clays and Clay Products of Iowa was practically finished as far as it was thought best at that time to carry the work; but before the manuscript was sent to press conditions arose which made it desirable to examine some new fields, to review some of the old ones, and to make a number of additional laboratory tests. This enlargement and revision of the work has occupied Professor Beyer during the year. The manuscript in its revised form is now ready, and I take pleasure in presenting it herewith and recommending its publication as volume XIV of the Iowa Geological reports. The work is one which is timely and will be especially welcome to the public. It is certain to prove of great usefulness to the state in the stimulation and intelligent direction it will give to the great industry of which it treats. At present the clay products of Iowa stand second in value only to the output of coal. Clays, however, are much more generally distributed than coal, and

they are far more abundant. Relatively speaking, the clay industry of Iowa is yet in its infancy. With workable beds that are practically inexhaustible, and almost limitless varieties adapted to every possible use, the industry has an assured future of growth and expansion as the people of the state, increasing in numbers, in wealth and in culture, demand better homes, better public buildings, better streets, better roads, more general and more artistic improvements of numberless kinds into which the products of the kiln may be incorporated.

The work on which this report is based has been in progress for a number of years, and it is but just to call your attention to the great amount of patient and painstaking labor which the preparation of such a monograph involves. I regard it as a duty as well as a privilege here to acknowledge the indebtedness of the Survey to the State College of Agriculture and Mechanic Arts which has so generously and heartily supported Professor Beyer and his associates by placing at their disposal, for purposes of the clay investigation, the resources of its testing and other laboratories. Without the equipment afforded by the laboratories of the college the work covered by the report could not have been accomplished. In addition to work on the monograph on clays, Professor Beyer, in accordance with the custom of past years, has collected and tabulated the statistics relating to the annual mineral production in Iowa.

The collection of data relating to the artesian waters of Iowa, another line of special work in which the Survey has, for some time, been engaged, has been kept up to date by Prof. W. H. Norton of Cornell College. During the past year arrangements have been made whereby the United States Geological Survey will co-operate with the Iowa Survey in the study of the state's artesian waters. Professor Norton will do the work for both organizations, and the expenses will be divided on an equitable basis between them.

The topographic work of the United States Survey in north-eastern Iowa, which has been in progress for a number of years, was practically completed last summer. It is almost impossible

A GEOLOGICAL MAP OF IOWA 1904.

Compiled from published sources and
from the notes of members of the survey.

SAMUEL CALVIN,
State Geologist.

Location of clay plants
using shale indicated by
small black triangles.

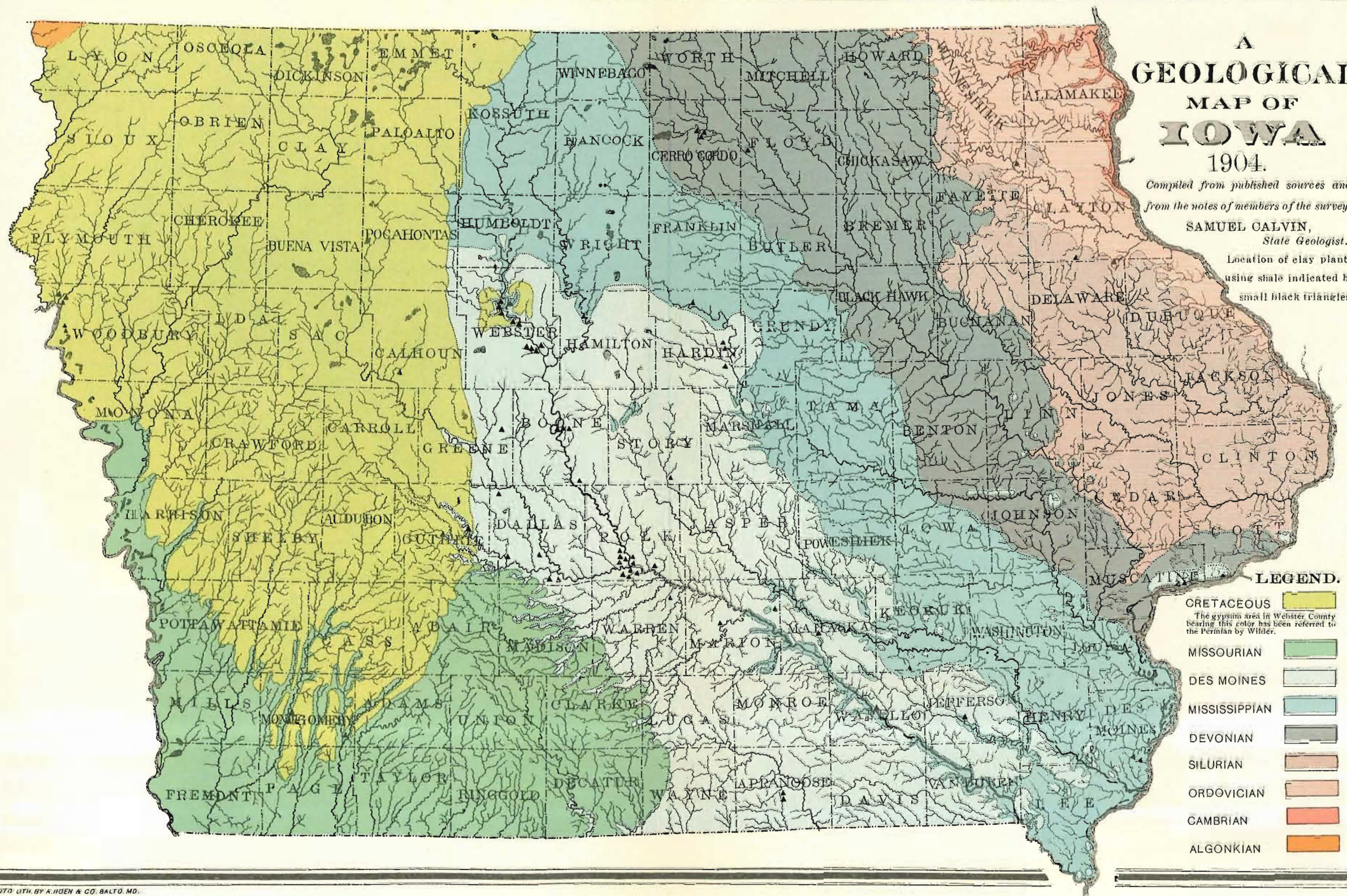

LEGEND.

- CRETACEOUS
The gypsum area in Webster County bearing this color has been referred to the Permian by Wilder.
- MISSOURIAN
- DES MOINES
- MISSISSIPPIAN
- DEVONIAN
- SILURIAN
- ORDOVICIAN
- CAMBRIAN
- ALGONKIAN

PHOTO LITH. BY A. HOEN & CO. BALTO. MD.

to estimate the value of this work to the Iowa Geological Survey. It has covered a portion of the state in which the satisfactory mapping of the geological formations would have been altogether impossible without the aid of topographic base maps. In the report on Dubuque county the Survey made use of the U. S. topographic sheets as the base on which to represent the geology. Through the courtesy of the National Survey, similar sheets will soon be available for the entire driftless and broken area in the northeastern part of our state, and the geological work may be completed more satisfactorily and with far less labor and expense than would otherwise have been possible.

Further co-operation of the United States Survey has been secured in the testing of cement-making materials. For some time the Iowa Survey has been collecting facts relative to the distribution of deposits presumably available for the manufacture of a good grade of Portland cement. It is believed that Iowa has an abundance of such materials. The final decision, however, concerning the value of any given beds can only be reached after thorough and expensive tests, and these the Survey has no means for making. With the aid of the United States Survey these tests can now be made, and accordingly, during the year, the necessary samples have been collected from quite a number of localities and forwarded to Washington for the purpose. We shall soon be in position to make authoritative statements on the possibilities of making Portland cement in Iowa.

As foreshadowed in the report of last year, the Survey is now ready to begin a thorough and comprehensive study of the coals of Iowa. This study will, as a matter of course, include an investigation of the modes of occurrence, and the physical and chemical characteristics of our Iowa coals, their geographical distribution and geological relations, the thickness and persistence of the seams, and the methods of prospecting and mining. In addition to the lines of investigation above enumerated, however, there should be carefully conducted tests on the effects of washing in preparing the coals for market, to what extent the range of utility and the market value of the coal have been improved,

and how far the improvement justifies the added expense. There should also be precise tests on the actual steaming value of the various grades and sizes of coal when burned on a working scale under the boiler; tests on coking and gas-making qualities; and experiments on the briquetting and utilization of wastes. The equipment of a plant for making scientific coal tests on a commercial scale is quite expensive, but it now seems probable that during the coming season arrangements can be made to have the Iowa coal tested with scientific precision at experimental plants specially designed for the purpose, by the United States Geological Survey; and thus we shall be again indebted to the generous co-operation of the national organization.

The other work carried on by the Survey has been almost wholly in the nature of areal investigation and geological mapping. The following counties have received attention during the year: Emmet, Palo Alto and Pocalontas in the area of the Wisconsin drift, which were examined and reported on by T. H. Macbride and R. I. Cratty; Clayton county, which was partly worked by A. G. Leonard in 1902 and finished by him in 1903; Clinton county, which was worked by Prof. J. A. Udden and Jan Andreas Udden; Winneshiek, which was nearly completed by Samuel Calvin and M. F. Arey; and Jasper county, in which work was commenced by Ira A. Williams. Some reconnoissance work, for the purpose of correlating outcrops in Winneshiek and Clayton, was done by Leonard, Calvin and Arey in Fayette county.

Volume XIII of the Survey reports has been printed and distributed during the past year; and the office work, which has greatly increased in the volume of correspondence and in other respects, both at Iowa City and Des Moines, has been kept up to date.

The Assistant State Geologist, Professor A. G. Leonard, was called to North Dakota about the first of September, to fill the position of State Geologist and Professor of Geology in the University of that state, and Professor T. E. Savage was elected to fill the position so made vacant.

IOWA GEOLOGICAL SURVEY
SAMUEL CALVIN, Director.

PRELIMINARY OUTLINE

MAP OF THE DRIFT SHEETS OF IOWA 1904.

Compiled from published sources
and the notes of
CALVIN, BAUS, LEVERETT, NORTON,
BEYER, WILDER, MACBRIDE,
LEONARD AND SAVAGE.

Scale: 18 Miles to 1 inch.

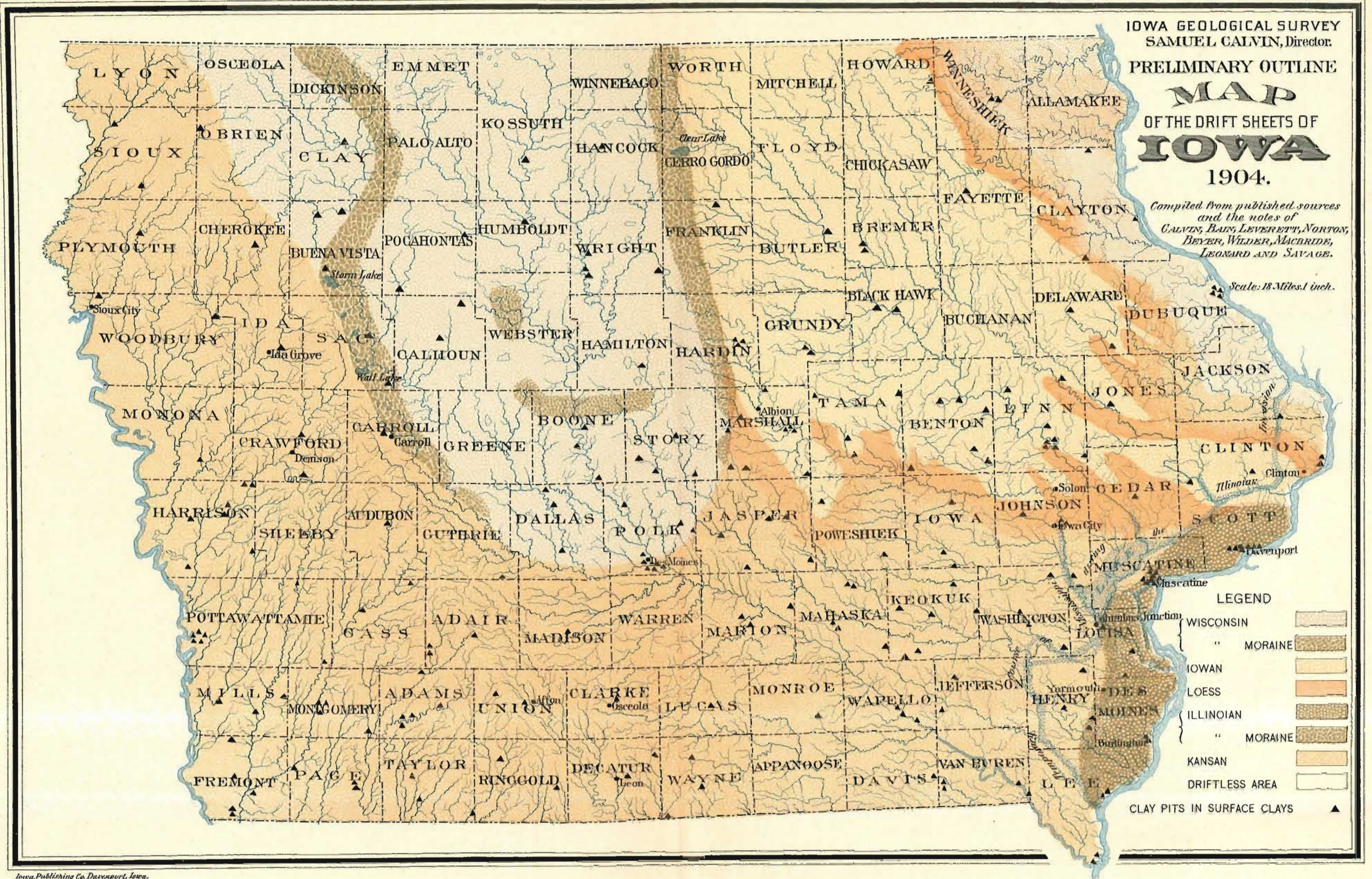

LEGEND

| | |
|----------------------------|--------------------------|
| WISCONSIN | [Light tan box] |
| " MORaine | [Dotted tan box] |
| IOWAN | [Light orange box] |
| LOESS | [Orange box] |
| ILLINOIAN | [Dark orange box] |
| " MORaine | [Dotted dark orange box] |
| KANSAN | [Light brown box] |
| DRIFTLESS AREA | [White box] |
| CLAY PITS IN SURFACE CLAYS | [Black triangle] |

Iowa Publishing Co. Davenport, Iowa.

MINERAL PRODUCTION OF IOWA

IN 1902

BY

S. W. BEYER.

VALUE OF MINERAL PRODUCTION.

1901.

| | |
|---------------------|--------------|
| Coal | \$ 8,051,806 |
| Clay | 2,774,200 |
| Stone | 794,278 |
| Gypsum | 562,500 |
| Lead and zinc | 16,500 |
| Iron ore | 4,876 |
| Total | \$12,204,160 |

1902.

| | |
|----------------|--------------|
| Coal | \$ 8,058,779 |
| Clay | 2,843,591 |
| Stone | 673,361 |
| Gypsum | 337,735 |
| Lead | 11,178 |
| Iron ore | |
| Total | \$11,924,644 |

MINERAL PRODUCTION IN IOWA FOR 1902.

BY S. W. BEYER.

Iowa practically held her own in mineral production for 1902 as compared with 1901 notwithstanding the unusual amount of inclement weather. Clay and coal show slight increases in values but falling off in quantity produced. Stone, more sensitive to weather conditions, shows a marked shrinkage both in value and quantity marketed. The production of lead has not been affected materially, the value showing a small loss. The production of gypsum shows but little change. Iowa's one iron mine was not a producer during 1902. The number of producers reporting shows an increase of six per cent over the preceding year owing largely

to the ferreting out of the country coal banks and small quarries by the special agents of the Census Bureau.

The number of producers for the various mineral industries of the state are shown below in parallel columns for the years 1900 to 1902 inclusive.

| | 1900. | 1901. | 1902. |
|--------------------|-------|-------|-------|
| Coal..... | 231 | 242 | 274 |
| Clay | 381 | 349 | 329 |
| Stone..... | 170 | 229 | 273 |
| Gypsum..... | 7 | 7 | 7 |
| Lead and zinc..... | 6 | 10 | 8 |
| Iron..... | 1 | 1 | 1 |
| | 796 | 838 | 892 |
| Total..... | | | |

The statistics for clay were gathered as usual through the co-operation of Federal and State Geological Surveys. The statistics for the other mineral products were secured through the Federal Census Bureau acting with the Division of Mining and Mineral Resources of the United States Geological Survey.

As during preceding years the producers have shown a commendable promptness in filling out and returning schedules sent them and it is a pleasure to accord them full acknowledgment for the service rendered the Survey.

The value of the total mineral production in Iowa for 1902 is shown in Table I.

MINERAL PRODUCTION BY COUNTIES.

TABLE No. I.

VALUE OF TOTAL MINERAL PRODUCTION BY COUNTIES FOR 1902.

| COUNTIES. | Number of producers. | Total coal. | Total clay. | Total stone | Miscellaneous. | Total. |
|-------------------|----------------------|-------------|-------------|-------------|----------------|-----------|
| Adair | 4 | | 12,210 | | | 12,210 |
| Adams | 21 | 42,193 | 26,652 | 2,159 | | 70,995 |
| Allamakee | 4 | | | 7,429 | | 7,429 |
| Appanoose | 53 | 1,284,253 | 15,950 | 222 | | 1,300,425 |
| Audubon | 1 | | 12,300 | | | 12,300 |
| Benton | 14 | | 22,423 | 5,884 | | 28,307 |
| Black Hawk | 14 | | 15,104 | 11,415 | | 26,519 |
| Boone | 21 | 509,624 | 53,987 | | | 563,611 |
| Bremer | 2 | | 1,252 | | | 1,252 |
| Buena Vista | 3 | | 22,000 | | | 22,000 |
| Buchanan | 1 | | 280 | | | 280 |
| Butler | 1 | | 1,966 | | | 1,966 |
| Calhoun | 3 | | 14,500 | | | 14,500 |
| Carroll | 1 | | 8,400 | | | 8,400 |
| Cass | 5 | | 12,405 | | | 12,405 |
| Cedar | 4 | | 8,318 | 69,034 | | 77,352 |
| Cerro Gordo | 12 | | 211,420 | 34,914 | | 246,334 |
| Cherokee | 1 | | 8,800 | | | 8,800 |
| Chickasaw | 1 | | 600 | | | 600 |
| Clarke | 8 | | 2,800 | 1,435 | | 4,235 |
| Clayton | 10 | | 7,608 | 7,030 | | 14,638 |
| Clinton | 16 | | 27,850 | 16,377 | | 44,227 |
| Crawford | 2 | | 11,820 | | | 11,820 |
| Dallas | 14 | 37,557 | 89,102 | 68 | | 126,727 |
| Davis | 10 | 16,573 | 2,775 | | | 19,348 |
| Decatur | 9 | | 5,375 | 1,756 | | 7,131 |
| Delaware | 6 | | 6,800 | 2,675 | | 9,475 |
| Des Moines | 17 | | 24,264 | 31,833 | | 56,097 |
| Dubuque | 25 | | 29,400 | 54,269 | 11,178 | 94,847 |
| Emmet | 1 | | 750 | | | 750 |
| Fayette | 11 | | 14,710 | 5,513 | | 20,223 |
| Floyd | 11 | | 2,983 | 6,693 | | 9,676 |
| Fremont | 5 | | 14,528 | | | 14,528 |
| Franklin | 1 | | 587 | | | 587 |
| Greene | 7 | 15,345 | 25,000 | | | 40,345 |
| Grundy | 1 | | 1,400 | | | 1,400 |
| Guthrie | 7 | 4,875 | 34,630 | | | 39,505 |
| Hamilton | 4 | | 67,800 | 2,873 | | 70,673 |
| Hancock | 1 | | 2,350 | | | 2,350 |
| Hardin | 12 | | 62,694 | 10,605 | | 73,299 |
| Harrison | 7 | | 22,345 | | | 22,345 |
| Henry | 6 | | 14,060 | 2,109 | | 16,169 |
| Howard | 6 | | 7,500 | 2,224 | | 9,724 |
| Humboldt | 3 | | 11,000 | 1,849 | | 12,849 |
| Ida | 1 | | 4,739 | | | 4,739 |
| Iowa | 5 | | 26,815 | | | 26,815 |
| Jackson | 7 | | | 70,011 | | 70,011 |
| Jasper | 25 | 334,963 | 31,500 | | | 366,463 |
| Jefferson | 8 | 19,678 | 17,698 | | | 37,376 |
| Johnson | 9 | | 37,275 | 5,500 | | 42,775 |
| Jones | 15 | | 7,876 | 90,716 | | 98,592 |

TABLE No. I—CONTINUED.

VALUE OF TOTAL MINERAL PRODUCTION BY COUNTIES FOR 1902.

| COUNTIES. | Number of producers. | Total coal. | Total clay. | Total stone. | Miscellaneous. | Total. |
|--------------------|----------------------|-------------|-------------|--------------|----------------|---------------|
| Keokuk..... | 33 | 251,769 | 31,450 | 2,700 | | 285,919 |
| Kossuth..... | 1 | | 960 | | | 960 |
| Lee..... | 21 | | 9,125 | 24,139 | | 33,264 |
| Linn..... | 15 | | 38,475 | 17,735 | | 56,210 |
| Louisa..... | 11 | | 7,400 | 4,205 | | 11,605 |
| Lucas..... | 4 | 318,993 | 3,000 | | | 321,993 |
| Madison..... | 11 | | 6,000 | 24,728 | | 30,728 |
| Mahaska..... | 28 | 732,686 | 65,775 | 285 | | 798,746 |
| Marion..... | 34 | 290,797 | 19,636 | 3,515 | | 313,948 |
| Marshall..... | 10 | | 33,111 | 58,096 | | 91,209 |
| Mills..... | 4 | | 14,500 | | | 14,500 |
| Mitchell..... | 6 | | | 3,545 | | 3,545 |
| Monona..... | | | | | | |
| Monroe..... | 15 | 1,736,432 | 8,365 | 504 | | 1,745,301 |
| Montgomery..... | 9 | | 40,540 | 5,105 | | 45,645 |
| Muscatine..... | 10 | | 37,408 | | | 37,408 |
| Page..... | 10 | 25,677 | 28,600 | | | 54,277 |
| Plymouth..... | 1 | | 3,500 | | | 3,500 |
| Pocahontas..... | 2 | | 33,420 | | | 33,420 |
| Polk..... | 38 | 1,507,431 | 40,412 | | | 1,997,843 |
| Pottawattamie..... | 8 | | 82,488 | | | 82,488 |
| Poweshiek..... | 3 | | 14,400 | | | 14,400 |
| Ringgold..... | 2 | | 10,500 | | | 10,500 |
| Sac..... | 1 | | 1,050 | | | 1,050 |
| Scott..... | 28 | 20,258 | 42,988 | 49,099 | | 112,345 |
| Shelby..... | 2 | | 12,890 | | | 12,890 |
| Sioux..... | 2 | | 14,800 | | | 14,800 |
| Story..... | 5 | 732 | 26,147 | | | 26,879 |
| Tama..... | 12 | | 54,470 | 267 | | 54,737 |
| Taylor..... | 7 | 29,186 | 10,421 | | | 39,607 |
| Union..... | 2 | | 20,300 | | | 20,300 |
| Van Buren..... | 15 | 24,499 | 8,360 | 889 | | 33,748 |
| Wapello..... | 27 | 460,056 | 73,833 | 23,910 | | 557,799 |
| Warren..... | 8 | 38,288 | | | | 38,288 |
| Washington..... | 9 | | 22,600 | 4,885 | | 27,485 |
| Wayne..... | 10 | 109,794 | 10,120 | | | 119,914 |
| Webster..... | 38 | 256,870 | 250,403 | 5,024 | 337,735 | 850,032 |
| Winneshiek..... | 3 | | 4,700 | 65 | | 4,765 |
| Woodbury..... | 6 | | 233,543 | | | 233,543 |
| Wright..... | 4 | | 13,300 | | | 13,300 |
| Total..... | 891 | \$3,058,779 | \$2,843,591 | \$673,361 | \$348,913 | \$ 11,924,644 |

COAL.

The price of coal ruled firm through the year with a sharp rise near the end of the year owing to the great strike in the anthracite fields of Pennsylvania. Notwithstanding high prices

and the apparent scarcity in fuels the returns show an actual falling off in production amounting to approximately 50,000 tons. The shortage is due to the abandonment of mines, formerly large producers, in Mahaska and Keokuk counties. Mahaska for many years the ranking coal producing county in the state fell to third place in 1901 and dropped to a poor fourth in 1902. Keokuk ranked fifth in 1901 and tenth in 1902. The increase in price stimulated the small mines as seen in the increased number producing and the increased outputs for the counties of small productions. Appanoose is the only other large producer showing a decrease. High prices have stimulated development work. Much prospecting has been done in many of the counties while important plants are being installed in Monroe, Marion, Polk, Boone and Webster counties which promise to materially increase the output for 1903.

Table II gives the total tonnage, average price per ton, total value, number of mines producing, average number of days worked and number of men employed, arranged by counties. An attempt has been made to collect statistics as to distribution which has not been done before. It is believed that the results are fairly reliable for coal shipped and coal sold locally, but little dependence can be placed on the amount used at the mines as but few companies returned a report. No data are at hand to determine the amounts of the various sizes of coal put upon the market. Mine run, steam coal, nut, pea and slack are included in the total. The average price per ton is, in reality, on a mine run basis, and must not be confused with the average price for lump coal which runs considerably higher in the counties which "shoot from the solid" and approximately the same where "long wall" is the system employed. The great difference in the average prices per ton in Marion and Monroe counties when compared with Boone may be more readily understood when it is known that the two former shoot from the solid and the latter mines long wall.

TABLE No. II.
COAL PRODUCTION BY COUNTIES FOR 1902.

| COUNTIES. | Number of producers. | Tons shipped. | Tons sold locally. | Tons used at the mine. | Total tons produced. | Total value. | Average price per ton. | Average number of men employed. | Average number of days worked. |
|----------------------|----------------------|---------------|--------------------|------------------------|----------------------|--------------|------------------------|---------------------------------|--------------------------------|
| Adams..... | 13 | | 18,103 | 44 | 18,147 | \$ 42,193 | \$ 2.32 | 249 | 88 |
| Appanoose..... | 47 | 732,873 | 22,235 | 16,255 | 771,363 | 1,284,253 | 1.66 | 198 | 2,032 |
| Boone..... | 11 | 235,062 | 24,790 | 4,672 | 264,524 | 509,624 | 1.93 | 221 | 727 |
| Dallas..... | 4 | 12,376 | 4,364 | 2,105 | 18,845 | 37,557 | 1.99 | 205 | 61 |
| Davis..... | 6 | | 3,633 | | 3,633 | 6,093 | 1.68 | 159 | 22 |
| Greene..... | 6 | | 11,501 | 72 | 11,573 | 15,345 | 1.33 | 132 | 51 |
| Guthrie..... | 2 | | 2,300 | | 2,300 | 4,875 | 2.12 | 200 | 12 |
| Jasper..... | 16 | 183,680 | 45,705 | 6,005 | 235,390 | 334,963 | 1.43 | 219 | 383 |
| Jefferson..... | 5 | 6,000 | 4,084 | 200 | 10,284 | 19,146 | 1.86 | 217 | 29 |
| Keokuk..... | 13 | 145,976 | 10,879 | 3,536 | 160,401 | 251,769 | 1.57 | 210 | 429 |
| Lucas..... | 3 | 223,218 | 6,983 | 8,661 | 238,862 | 318,993 | 1.33 | 259 | 460 |
| Mahaska..... | 18 | 500,791 | 37,803 | 10,651 | 549,245 | 732,203 | 1.33 | 199 | 1,168 |
| Marion..... | 24 | 233,061 | 31,878 | 4,785 | 269,724 | 290,419 | 1.08 | 218 | 474 |
| Monroe..... | 10 | 1,303,480 | 22,014 | 24,228 | 1,349,722 | 1,736,432 | 1.29 | 266 | 2,158 |
| Page..... | 5 | | 10,022 | 48 | 10,070 | 25,277 | 2.51 | 222 | 45 |
| Polk..... | 20 | 765,345 | 213,975 | 28,540 | 1,007,860 | 1,507,431 | 1.50 | 248 | 1,741 |
| Scott..... | 7 | | 10,176 | 182 | 10,358 | 19,858 | 1.92 | 148 | 41 |
| Story..... | 1 | | 244 | | 244 | 732 | 3.00 | 70 | 7 |
| Taylor..... | 3 | 8,357 | 4,585 | 65 | 13,007 | 29,186 | 2.24 | 218 | 53 |
| Van Buren..... | 5 | 10,836 | 3,967 | 13 | 14,816 | 24,499 | 1.65 | 240 | 32 |
| Wapello..... | 16 | 257,937 | 77,229 | 5,413 | 340,579 | 460,056 | 1.36 | 260 | 668 |
| Warren..... | 8 | 9,727 | 10,200 | 200 | 20,127 | 38,288 | 1.90 | 178 | 76 |
| Wayne..... | 4 | 53,199 | 9,667 | 1,298 | 64,164 | 109,734 | 1.71 | 204 | 208 |
| Webster..... | 16 | 109,341 | 27,449 | 3,217 | 140,007 | 256,470 | 1.83 | 232 | 299 |
| Small producers..... | 11 | | 2,016 | | 2,016 | 3,403 | 1.69 | 160 | 12 |
| Total..... | 274 | 4,791,259 | 615,702 | 120,190 | 5,527,263 | \$ 8,058,799 | \$ 1.46 | 218 | 11,205 |

The effect of the anthracite coal strike and the consequent high price of bituminous coal greatly stimulated the production in Iowa. The increase is rendered obvious when the production for the year ending June 30, 1903, is inspected. Table III shows the number of mines in operation, tons of coal produced and number of miners and others employed and is taken from the Eleventh Biennial Report of the State Mine Inspectors.

TABLE No. III.

COAL PRODUCTION FOR THE YEAR ENDING JUNE 30, 1903.

| COUNTIES. | Number of mines. | Tons of coal of all grades produced. | Number of miners employed. | Other employees. | Total number employed. |
|----------------|------------------|--------------------------------------|----------------------------|------------------|------------------------|
| Adams..... | 12 | 16,462 | 85 | 16 | 101 |
| Appanoose..... | 70 | 892,692 | 1,889 | 600 | 2,499 |
| Boone..... | 12 | 288,655 | 480 | 165 | 645 |
| Dallas..... | 6 | 19,900 | 75 | 35 | 110 |
| Davis..... | 4 | 3,200 | 12 | 4 | 16 |
| Greene..... | 6 | 12,711 | 56 | 9 | 65 |
| Guthrie..... | 13 | 16,545 | 75 | 15 | 90 |
| Jasper..... | 13 | 323,312 | 508 | 182 | 690 |
| Jefferson..... | 4 | 4,000 | 13 | 3 | 16 |
| Keokuk..... | 15 | 82,532 | 156 | 70 | 226 |
| Lucas..... | 3 | 269,549 | 327 | 202 | 529 |
| Mahaska..... | 26 | 678,826 | 929 | 453 | 1,382 |
| Marion..... | 18 | 293,875 | 400 | 175 | 575 |
| Monroe..... | 19 | 1,600,148 | 1,758 | 1,081 | 2,839 |
| Page..... | 4 | 9,674 | 37 | 8 | 45 |
| Polk..... | 25 | 996,573 | 1,127 | 488 | 1,635 |
| Scott..... | 7 | 18,280 | 80 | 12 | 92 |
| Taylor..... | 8 | 20,618 | 74 | 22 | 96 |
| Van Buren..... | 7 | 18,740 | 52 | 20 | 72 |
| Wapello..... | 13 | 365,165 | 506 | 259 | 765 |
| Warren..... | 10 | 20,265 | 65 | 25 | 90 |
| Wayne..... | 8 | 74,542 | 185 | 65 | 256 |
| Webster..... | 10 | 159,990 | 280 | 104 | 384 |
| Total..... | 313 | 6,185,734 | 9,169 | 4,023 | 13,192 |

The shifting of the great producing center toward Monroe and Marion counties can be seen to advantage when the counties are tabulated in parallel columns for the years 1900 to 1902 inclusive, as shown in Table IV.

MINERAL PRODUCTION OF IOWA.

TABLE No. IV.

COAL PRODUCTION FOR THE YEARS 1900 TO 1902, INCLUSIVE.

| COUNTIES. | 1900. | | 1901. | | 1902. | |
|----------------------|-----------|-------------|-----------|-------------|-----------|-------------|
| | Tons. | Value. | Tons. | Value. | Tons. | Value. |
| Adams | 21,950 | \$ 41,764 | 18,091 | \$ 36,395 | 18,147 | \$ 42,193 |
| Appanoose..... | 680,094 | 1,029,489 | 721,997 | 1,121,265 | 771,363 | 1,284,253 |
| Boone..... | 266,542 | 451,056 | 254,054 | 423,827 | 264,524 | 509,624 |
| Dallas..... | 16,737 | 30,531 | 16,987 | 31,072 | 18,845 | 37,557 |
| Davis | 1,398 | 2,395 | 1,986 | 3,913 | 3,633 | 6,093 |
| Greene..... | 17,044 | 31,699 | 18,810 | 31,652 | 11,573 | 15,345 |
| Guthrie..... | | | | | 2,300 | 4,875 |
| Jasper..... | 99,948 | 135,462 | 184,670 | 270,369 | 235,390 | 334,963 |
| Jefferson..... | 3,650 | 6,062 | 3,875 | 7,568 | 10,284 | 19,146 |
| Keokuk..... | 258,933 | 353,145 | 308,193 | 425,876 | 160,403 | 251,769 |
| Lucas..... | 227,921 | 300,840 | 221,058 | 274,416 | 238,862 | 318,993 |
| Mahaska..... | 1,142,017 | 1,408,655 | 929,110 | 1,161,243 | 549,245 | 732,203 |
| Marion..... | 186,446 | 234,009 | 145,981 | 173,882 | 269,724 | 290,419 |
| Monroe..... | 755,286 | 859,720 | 1,038,332 | 1,292,503 | 1,349,722 | 1,736,432 |
| Page and Story | 8,494 | 22,725 | 6,740 | 16,850 | 10,314 | 26,009 |
| Polk..... | 827,482 | 1,250,430 | 1,025,014 | 1,492,060 | 1,007,860 | 1,507,431 |
| Scott..... | 29,846 | 49,174 | 17,097 | 27,376 | 10,358 | 19,858 |
| Taylor..... | 17,159 | 34,318 | 23,499 | 49,570 | 13,007 | 29,186 |
| Van Buren..... | 12,108 | 17,880 | 12,572 | 18,997 | 14,816 | 24,499 |
| Wapello..... | 276,360 | 359,616 | 312,174 | 407,136 | 340,579 | 460,056 |
| Warren..... | 24,720 | 34,695 | 14,661 | 27,847 | 20,127 | 38,288 |
| Wayne..... | 65,140 | 93,584 | 56,578 | 88,486 | 64,164 | 109,734 |
| Webster..... | 123,660 | 230,092 | 146,020 | 265,501 | 140,007 | 256,470 |
| Small mines..... | 140,000 | 175,000 | 140,000 | 175,000 | 2,016 | 3,403 |
| Total..... | 5,202,939 | \$7,155,341 | 5,617,499 | \$7,822,805 | 5,527,263 | \$8,058,799 |

No reason can be given to account for the decrease in the number of men employed when compared with preceding years. In the table below is given the average number of days worked and the number of men employed during the past ten years.

| YEARS. | AVERAGE NUMBER OF DAYS WORKED. | NUMBER OF MEN EMPLOYED. |
|-----------|--------------------------------|-------------------------|
| 1893..... | 204 | 8,863 |
| 1894..... | 170 | 9,995 |
| 1895..... | 189 | 10,066 |
| 1896..... | 178 | 9,672 |
| 1897..... | 201 | 10,703 |
| 1898..... | 218 | 10,256 |
| 1899..... | 229 | 10,268 |
| 1900..... | 228 | 11,601 |
| 1901..... | 223 | 13,032 |
| 1902..... | 218 | 11,205 |

According to the authority of the United States Geological Survey, Iowa ranked eighth in tonnage and sixth in the value of the output for 1901, producing 2½ per cent of the bituminous coal of the entire country. The table below shows the rank of the ten leading producers.

| | TONS. | VALUE. |
|-------------------------------------|------------|---------------|
| Pennsylvania (bituminous only)..... | 82,305,946 | \$ 81,397,585 |
| Illinois..... | 27,331,552 | 28,163,937 |
| West Virginia..... | 24,068,402 | 20,848,184 |
| Ohio..... | 20,943,807 | 20,928,158 |
| Alabama..... | 9,099,052 | 10,000,892 |
| Indiana..... | 6,918,225 | 7,017,143 |
| Colorado..... | 5,700,015 | 6,441,891 |
| Iowa..... | 5,617,499 | 7,822,805 |
| Kentucky..... | 5,469,986 | 5,213,076 |
| Kansas..... | 5,113,127 | 5,046,491 |

Iowa's production during the past nine years, with average price per ton and value, may be viewed in the table below:

| YEARS. | SHORT TONS. | AVERAGE PRICE PER TON. | VALUE. | AUTHORITY. |
|--------|-------------|---------------------------|-------------|------------------|
| 1894 | 3,967,253 | \$1.26 | \$4,999,939 | U. S. G. S. |
| 1895 | 4,156,074 | 1.20 | 4,982,102 | U. S. G. S. |
| 1896 | 3,954,028 | 1.17 | 4,628,022 | U. S. G. S. |
| 1897 | 4,611,865 | 1.13 | 5,219,503 | U. S. G. S. |
| 1898 | 4,618,842 | 1.14 | 5,260,716 | U. S. G. S. |
| 1899 | 5,177,479 | 1.24 | 6,399,338 | U. S. G. S. |
| 1900 | 5,202,939 | 1.38 | 7,155,341 | U. S. G. S. |
| 1901 | 5,617,499 | 1.39 | 7,822,805 | U. S. G. S. |
| 1902 | 5,527,263 | 1.46 | 8,058,799 | Iowa Geol. Surv. |

CLAY.

In spite of the large amount of time lost and the embarrassments due to an excess of wet weather, the clay goods marketed in 1902 brought the producers 2 per cent more money than the production for 1901. The total output of clay goods shows a slight shrinkage but the higher prices more than made good the reduction in output. The greatest increases are shown in drain

tile, sewer pipe, hollow building block and pottery while the greatest shrinkage occurred in burnt clay ballast. Slight reduction both in quantity and value is shown for building, face and paving brick.

The clay wares produced in 1902 were distributed as follows:

| | 1902. | | 1901. | | Per cent Increase. | Per cent decrease. |
|--------------------------------|------------|--------------|------------|--------------|-----------------------|-----------------------|
| | Thousands. | Value. | Thousands. | Value. | | |
| Common brick... | 236,399 | \$ 1,624,673 | 254,432 | \$ 1,651,926 | | 1.5 |
| Front brick | 7,584 | 81,211 | 8,577 | 85,330 | | 5. |
| Paving brick..... | 21,779 | 212,537 | 22,530 | 227,378 | | 6.5 |
| Fancy or orna- mental | | 1,690 | | 2,229 | | 24. |
| Fire brick. | | 850 | | 803 | | 5.8 |
| Drain tile..... | | 673,122 | | 516,714 | 32.2 | |
| Sewer pipe..... | | 76,000 | | 53,500 | 42. | |
| Hollow block..... | | 104,324 | | 59,270 | 76. | |
| Sidewalk brick... | | 1,335 | | 1,570 | | 14.8 |
| Tile, not drain tile. | | 2,590 | | | | |
| Railway ballast... | | 13,527 | | 101,500 | | 86.7 |
| Pottery | | 45,387 | | 26,200 | 73. | |
| Miscellaneous..... | | 6,345 | | 17,780 | | 64. |
| Total..... | | \$2,843,591 | | \$ 2,774,200 | | |

The number of factories in operation decreased from 349 in 1901 to 329 for 1902, mainly due to the continued wet weather which made out door drying almost impossible, and open sheds and open kilns unprofitable. Those plants using surface clays were the greatest sufferers.

The distribution of the output for 1902 as compared with the output for 1901 is shown in tabular form below. It is obvious that the excess of moisture proved a great stimulus to the manufacture of drain tile and sewer pipe. The larger sizes of drain tile up to eighteen inches in diameter are gaining favor in some portions of the state in the building of culverts on the public highways. For the manufacture of extra sizes the sewer pipe press is used.

The average price for building brick shows a sharp advance, common brick selling at the yards at an average of \$6.87 as com-

pared with \$6.49 and \$6.47 for the years 1901 and 1900 respectively. Face brick sold for an average of \$10.71 per M against \$9.95 per M for the year preceding. The average price of paving brick did not change materially. Fire brick and ornamental brick are not produced in quantity. All of the fire brick manufactured in the state are made by the stiff mud process without the addition of "grog." Hollow block show a good increase in the counties which ship the bulk of their production considerable distances.

The distribution of clay products by counties, showing the common brick and total brick in thousands, the values of common brick and of total brick, value of drain tile and total value of clay products are shown in Table V.

TABLE V.
CLAY PRODUCTION BY COUNTIES FOR 1902.

| COUNTIES. | Number of producers. | THOUSANDS. | | VALUE. | | | |
|-------------------|----------------------|---------------|--------------|---------------|--------------|-------------|-------------|
| | | Common brick. | Total brick. | Common brick. | Total brick. | Drain tile. | Total clay. |
| Adair | 4 | 1,370 | 1,470 | \$ 10,360 | \$ 11,760 | \$ 450 | \$ 12,210 |
| Adams | 6 | 2,825 | 2,825 | 19,650 | 19,650 | 300 | 26,652 |
| Appanoose | 2 | 2,275 | 2,275 | 15,950 | 15,950 | | 15,950 |
| Audubon | 1 | 1,800 | 1,800 | 12,000 | 12,000 | 300 | 12,300 |
| Benton | 6 | 1,725 | 1,779 | 11,425 | 11,864 | 10,559 | 22,423 |
| Black Hawk | 3 | 2,343 | 2,343 | 15,104 | 15,104 | | 15,104 |
| Boone | 10 | 4,169 | 5,410 | 33,092 | 46,377 | 6,860 | 53,987 |
| Bremer | 2 | 157 | 157 | 1,252 | 1,252 | | 1,252 |
| Buchanan | 1 | 35 | 35 | 280 | 280 | | 280 |
| Buena Vista | 3 | 450 | 450 | 3,600 | 3,600 | 18,400 | 22,000 |
| Butler | 1 | 256 | 256 | 1,966 | 1,966 | | 1,966 |
| Calhoun | 3 | 125 | 125 | 1,000 | 1,000 | 11,500 | 14,500 |
| Carroll | 1 | 1,200 | 1,200 | 8,400 | 8,400 | | 8,400 |
| Cass | 5 | 1,670 | 1,670 | 12,405 | 12,405 | | 12,405 |
| Cedar | 1 | 670 | 670 | 4,685 | 4,685 | 3,633 | 8,318 |
| Cerro Gordo | 3 | 8,900 | 8,900 | 57,850 | 57,850 | 84,200 | 211,420 |
| Cherokee | 1 | 1,139 | 1,139 | 8,500 | 8,500 | 300 | 8,800 |
| Chickasaw | 1 | 100 | 100 | 600 | 600 | | 600 |
| Clarke | 1 | 400 | 400 | 2,800 | 2,800 | | 2,800 |
| Clayton | 3 | 1,240 | 1,240 | 7,328 | 7,328 | 200 | 7,608 |
| Clinton | 5 | 4,325 | 4,325 | 25,100 | 25,100 | 2,750 | 27,850 |
| Crawford | 2 | 1,700 | 1,720 | 11,600 | 11,820 | | 11,820 |
| Dallas | 8 | 4,197 | 5,280 | 30,275 | 43,410 | 45,692 | 89,102 |

MINERAL PRODUCTION OF IOWA.

TABLE V—CONTINUED.

CLAY PRODUCTION BY COUNTIES FOR 1902.

| COUNTIES. | Number of producers. | THOUSANDS. | | VALUE. | | | |
|--------------------|----------------------|---------------|--------------|---------------|--------------|-------------|-------------|
| | | Common brick. | Total brick. | Common brick. | Total brick. | Drain tile. | Total clay. |
| Davis..... | 3 | 375 | 375 | \$ 2,775 | \$ 2,775 | | \$ 2,775 |
| Decatur..... | 3 | 750 | 750 | 5,175 | 5,175 | \$ 200 | 5,375 |
| Delaware..... | 3 | 800 | 800 | 5,000 | 5,000 | | 6,800 |
| Des Moines..... | 5 | 2,458 | 2,458 | 21,319 | 21,319 | 800 | 24,264 |
| Dubuque..... | 3 | 4,700 | 4,700 | 29,400 | 29,400 | | 29,400 |
| Emmet..... | 1 | 50 | 50 | 400 | 400 | 350 | 750 |
| Fayette..... | 4 | 1,621 | 1,921 | 10,710 | 13,710 | | 14,710 |
| Floyd..... | 1 | 400 | 400 | 2,800 | 2,800 | 93 | 2,893 |
| Franklin..... | 1 | 52 | 52 | 314 | 314 | 273 | 587 |
| Fremont..... | 5 | 2,515 | 2,515 | 14,528 | 14,528 | | 14,528 |
| Greene..... | 1 | 200 | 200 | 1,400 | 1,400 | 23,600 | 25,000 |
| Grundy..... | 1 | 200 | 200 | 1,400 | 1,400 | | 1,400 |
| Guthrie..... | 5 | 1,496 | 1,496 | 10,714 | 10,714 | 23,916 | 34,630 |
| Hamilton..... | 2 | 2,200 | 2,200 | 15,400 | 15,400 | 52,400 | 67,800 |
| Hancock..... | 1 | 100 | 100 | 850 | 850 | 1,500 | 2,350 |
| Hardin..... | 6 | 1,150 | 1,150 | 8,435 | 8,435 | 54,259 | 62,694 |
| Harrison..... | 7 | 3,020 | 3,030 | 22,265 | 22,345 | | 22,345 |
| Henry..... | 4 | 767 | 767 | 5,490 | 5,740 | 8,320 | 14,060 |
| Howard..... | 1 | 1,000 | 1,000 | 6,500 | 6,500 | 500 | 7,500 |
| Humboldt..... | 1 | 143 | 143 | 1,000 | 1,000 | 10,000 | 11,000 |
| Ia..... | 1 | 615 | 615 | 4,739 | 4,739 | | 4,739 |
| Iowa..... | 5 | 2,827 | 2,877 | 17,915 | 18,415 | 8,400 | 26,815 |
| Jasper..... | 9 | 3,450 | 3,950 | 22,950 | 27,200 | 4,300 | 31,500 |
| Jefferson..... | 2 | 830 | 830 | 6,022 | 6,022 | 11,676 | 17,698 |
| Johnson..... | 7 | 5,079 | 5,079 | 28,275 | 28,275 | 9,000 | 37,275 |
| Jones..... | 2 | 807 | 807 | 5,456 | 5,456 | 2,420 | 7,876 |
| Keokuk..... | 7 | 1,300 | 1,300 | 9,200 | 9,200 | 21,850 | 31,450 |
| Kossuth..... | 1 | 160 | 160 | 960 | 960 | | 960 |
| Lee..... | 5 | 1,310 | 1,490 | 7,590 | 8,900 | 225 | 9,125 |
| Linn..... | 8 | 5,205 | 5,205 | 34,111 | 34,111 | 4,364 | 38,475 |
| Louisa..... | 4 | 617 | 617 | 3,900 | 3,900 | 700 | 7,400 |
| Lucas..... | 1 | 500 | 500 | 3,000 | 3,000 | | 3,000 |
| Madison..... | 1 | 500 | 500 | 4,500 | 4,500 | 1,500 | 6,000 |
| Mahaska..... | 6 | 4,323 | 6,935 | 31,249 | 57,675 | 8,000 | 65,775 |
| Marion..... | 5 | 2,288 | 2,288 | 16,722 | 16,722 | 2,914 | 19,636 |
| Marshall..... | 8 | 3,538 | 4,038 | 22,134 | 26,134 | 6,977 | 33,111 |
| Mills..... | 4 | 2,300 | 2,300 | 14,500 | 14,500 | | 14,500 |
| Monroe..... | 3 | 205 | 205 | 1,540 | 1,540 | | 8,365 |
| Montgomery..... | 5 | 4,910 | 4,910 | 35,140 | 35,390 | | 40,540 |
| Muscatine..... | 10 | 4,970 | 4,970 | 32,078 | 32,108 | | 37,408 |
| Page..... | 4 | 4,200 | 4,200 | 27,900 | 27,900 | 700 | 28,600 |
| Plymouth..... | 1 | 500 | 500 | 3,500 | 3,500 | | 3,500 |
| Pocahontas..... | 2 | 340 | 340 | 2,420 | 2,420 | 31,000 | 33,420 |
| Polk..... | 18 | 33,033 | 45,256 | 250,306 | 377,662 | 30,150 | 490,412 |
| Pottawattamie..... | 8 | 11,064 | 12,664 | 69,688 | 82,488 | | 82,488 |
| Poweshiek..... | 3 | 642 | 642 | 4,300 | 4,300 | 9,200 | 14,400 |
| Ringgold..... | 2 | 1,500 | 1,500 | 9,500 | 9,500 | 1,000 | 10,500 |
| Sac..... | 1 | 150 | 150 | 1,050 | 1,050 | | 1,050 |
| Scott..... | 6 | 4,844 | 5,844 | 30,288 | 40,288 | 300 | 42,988 |
| Shelby..... | 2 | 1,700 | 1,700 | 12,750 | 12,750 | 140 | 12,890 |

TABLE V—CONTINUED.

CLAY PRODUCTION BY COUNTIES FOR 1902.

| COUNTIES. | Number of producers. | THOUSANDS. | | VALUE. | | | |
|-----------------|----------------------|---------------|--------------|---------------|--------------|-------------|-------------|
| | | Common brick. | Total brick. | Common brick. | Total brick. | Drain tile. | Total clay. |
| Sioux..... | 2 | 2,100 | 2,100 | \$ 14,800 | \$ 14,800 | | \$ 14,800 |
| Story..... | 4 | 934 | 1,284 | 7,697 | 10,647 | \$ 15,500 | 26,147 |
| Tama..... | 5 | 4,038 | 5,576 | 25,986 | 40,970 | 13,500 | 54,470 |
| Taylor..... | 4 | 1,520 | 1,520 | 10,421 | 10,421 | | 10,421 |
| Union..... | 2 | 2,810 | 2,835 | 19,670 | 19,920 | 380 | 20,300 |
| Van Buren..... | 5 | 1,190 | 1,190 | 8,060 | 8,160 | 200 | 8,360 |
| Wapello..... | 5 | 9,470 | 10,800 | 57,341 | 67,419 | 6,414 | 73,833 |
| Washington..... | 3 | 2,700 | 2,700 | 17,500 | 17,500 | 5,100 | 22,600 |
| Wayne..... | 5 | 1,345 | 1,345 | 9,120 | 9,120 | 1,000 | 10,120 |
| Webster..... | 10 | 11,441 | 14,658 | 68,450 | 103,450 | 102,657 | 250,403 |
| Winneshek..... | 2 | 725 | 725 | 4,700 | 4,700 | | 4,700 |
| Woodbury..... | 6 | 27,211 | 28,641 | 204,948 | 218,543 | | 233,543 |
| Wright..... | 4 | 140 | 140 | 1,200 | 1,200 | 12,100 | 13,300 |
| Total..... | 329 | 236,399 | 265,762 | \$1,624,673 | \$1,920,961 | \$673,122 | \$2,843,591 |

During the four years preceding 1902 Iowa ranked eighth as a clay producer. In 1901 Iowa manufactured 2.48 per cent of all of the clay products marketed in the United States. Only four states, Ohio, Pennsylvania, Illinois and Indiana show a larger number of producers.

The table below gives the ten leading producers of clay products for 1901 according to the figures given in the mineral resources for 1901.

| RANK. | STATE. | OPERATORS REPORTING. | VALUE TOTAL CLAY PRODUCTS. | PER CENT TOTAL PRODUCT FOR THE UNITED STATES. |
|-------|--------------------|----------------------|----------------------------|---|
| 1 | Ohio..... | 813 | \$21,574,985 | 19.58 |
| 2 | Pennsylvania..... | 507 | 15,321,742 | 13.90 |
| 3 | New Jersey..... | 160 | 11,681,878 | 10.60 |
| 4 | Illinois..... | 550 | 9,642,490 | 8.75 |
| 5 | New York..... | 276 | 8,291,718 | 7.52 |
| 6 | Missouri..... | 259 | 4,474,553 | 4.06 |
| 7 | Indiana..... | 540 | 4,466,454 | 4.05 |
| 8 | Iowa..... | 341 | 2,737,825 | 2.48 |
| 9 | West Virginia..... | 53 | 1,946,480 | 1.77 |
| 10 | Massachusetts..... | 90 | 1,870,837 | 1.70 |

STONE.

The majority of the stone producers of the state report the demand for stone good or equal to that for 1901 but add that the rainy weather and consequent flooded streams made quarrying operations impossible for a considerable portion of the year. The greatest falling off was in the production of lime. Building stone shows a loss of more than 20 per cent. Riprap and rubble show an increase of more than 1.50 per cent. The production was distributed as follows:

| | 1902. | 1901. |
|---------------------------|------------------|-------------------|
| Limestone used for— | | |
| Building purposes..... | \$202,476 | \$ 261,160 |
| Flagging and curbing..... | 11,391 | 18,095 |
| Lime..... | 131,532 | 230,188 |
| Riprap and rubble..... | 176,883 | 66,355 |
| Crushed stone— | | |
| Macadam..... | 93,433 | 68,580 |
| Railway ballast..... | 15,944 | 48,509 |
| Concrete..... | 24,445 | 75,182 |
| Miscellaneous..... | 6,459 | 15,387 |
| Sandstone..... | 10,798 | 13,096 |
| Marble..... | 200 | |
| Total..... | \$673,561 | \$ 796 852 |

The "Good Roads" movement is reflected in the increased production of crushed stone for macadam. The increase for the year is about 35 per cent. Table VI gives the production by counties and specifies the various grades of stone put upon the market.

TABLE No. VI.
PRODUCTION OF LIMESTONE BY COUNTIES FOR 1902.

| COUNTIES. | Number of producers. | Building. | Flagging and curbing. | Lime. | Macadam. | Railway ballast. | Concrete. | Rubble and riprap. | Other purposes. | Total. |
|------------------|----------------------|-----------|-----------------------|--------|----------|------------------|-----------|--------------------|-----------------|--------|
| Adams..... | 2 | 1,950 | | | | | 50 | 150 | | 2,150 |
| Allamakee..... | 3 | 4,290 | | | | | | 39 | 3,100 | 7,429 |
| Appanoose..... | 4 | 72 | | | | | | 150 | | 222 |
| Benton..... | 8 | 24 | | 2,020 | | | | 3,840 | | 5,884 |
| Black Hawk..... | 11 | 2,846 | 204 | | 750 | | | 7,615 | | 11,415 |
| Cedar..... | 3 | 13,826 | | 13,678 | 30,863 | | 2,462 | 8,205 | | 69,034 |
| Cerro Gordo..... | 9 | 9,291 | 1,115 | 5,075 | | 10,632 | 758 | 8,043 | | 34,914 |
| Clarke..... | 7 | 1,435 | | | | | | | | 1,435 |
| Clayton..... | 6 | 920 | 800 | 750 | 640 | | | 3,745 | | 6,855 |
| Clinton..... | 10 | 12,086 | 200 | | 3,951 | | | 75 | | 16,312 |
| Dallas..... | 2 | 68 | | | | | | | | 68 |
| Decatur..... | 5 | 1,530 | 25 | | | | | | 192 | 1,747 |
| Delaware..... | 3 | 2,400 | | | | | | 275 | | 2,675 |
| Des Moines..... | 11 | 8,796 | 2,610 | | 625 | | 3,525 | 16,077 | | 31,633 |
| Dubuque..... | 14 | 11,743 | 1,708 | 10,700 | 1,500 | 4,550 | 5,050 | 19,018 | | 54,269 |
| Fayette..... | 6 | 2,005 | | 1,000 | | | | 2,308 | | 5,313 |
| Floyd..... | 10 | 3,419 | 124 | | | | | 3,150 | | 6,693 |
| Hardin..... | 6 | 4,555 | | | | | 50 | 6,000 | | 10,605 |
| Hamilton..... | 2 | 2,873 | | | | | | | | 2,873 |
| Henry..... | 2 | 1,714 | | | | | 363 | | 32 | 2,109 |
| Howard..... | 5 | 2,111 | | | 108 | | | 5 | | 2,224 |
| Humboldt..... | 2 | 1,825 | 24 | | | | | | | 1,849 |
| Jackson..... | 7 | 525 | | 69,098 | 200 | | | 188 | | 70,011 |
| Johnson..... | 2 | 600 | | | 3,400 | | 100 | 1,400 | | 5,500 |
| Jones..... | 12 | 34,088 | 1,566 | | 14,195 | 622 | 4,574 | 34,621 | | 89,666 |
| Keokuk..... | 12 | 2,235 | 18 | | 54 | | | 3 | | 2,450 |
| Linn..... | 7 | 5,600 | 20 | 10,000 | 2,040 | | | 75 | | 17,735 |
| Louisa..... | 7 | 1,488 | 160 | | | | 5 | 2,552 | | 4,205 |

PRODUCTION OF LIMESTONE BY COUNTIES.

TABLE No. VI—CONTINUED.
 PRODUCTION OF LIMESTONE BY COUNTIES FOR 1902.

| COUNTIES. | Number of producers. | Building. | Flagging and curbing. | Lime. | Macadam. | Railway ballast. | Concrete. | Rubble and riprap. | Other purposes | Total. |
|-----------------|----------------------|-----------|-----------------------|---------|----------|------------------|-----------|--------------------|----------------|---------|
| Lee..... | 11 | 4,620 | 601 | 6,935 | | | 6,183 | 1,893 | 1,510 | 21,742 |
| Madison..... | 10 | 11,408 | | | 10,435 | | | 2,885 | | 24,728 |
| Mahaska..... | 2 | 231 | 48 | | | | | 6 | | 285 |
| Marion..... | 2 | | | | | | | 2,500 | | 2,500 |
| Marshall..... | 2 | 14,700 | | | 16,065 | | | 27,331 | | 58,096 |
| Mitchell..... | 6 | 1,485 | 1,800 | | | | 25 | 210 | 25 | 3,545 |
| Monroe..... | 2 | 491 | 13 | | | | | | | 504 |
| Montgomery..... | 4 | 1,305 | | | | | | 3,800 | | 5,105 |
| Scott..... | 13 | 9,410 | | 12,266 | 7,665 | | | 19,658 | | 48,999 |
| Tama..... | 3 | 200 | | | 17 | | | 50 | | 267 |
| Van Buren..... | 3 | 457 | | | | | | | 200 | 657 |
| Wapello..... | 6 | 20,919 | 215 | | 800 | 140 | 1,310 | 526 | | 23,910 |
| Washington..... | 6 | 2,935 | | | 125 | | | 425 | 1,400 | 4,885 |
| Winneshiek..... | 1 | | | | | | | 65 | | 65 |
| Total..... | 249 | 202,476 | 11,391 | 131,522 | 93,433 | 15,944 | 24,455 | 176,883 | 6,459 | 662,563 |

Jackson county suffered the greatest shrinkage owing to the falling off in lime burning. Cedar, Jones, Dubuque and Scott suffered less, while Des Moines, Marshall and Cerro Gordo show good gains over the preceding year.

The sandstone production shows but slight change. Webster county is still the principal producer. The production of sandstone was distributed as follows:

| | |
|----------------------|----------|
| Building stone | \$ 6,331 |
| Rubble | 3,157 |
| Flagging | 75 |
| Concrete | 35 |
| Guttering | 1,200 |
| Total | \$10,798 |

Number of producers, 24.

In 1901 Iowa ranked twenty-second as a stone producer and eighth in the production of limestone, producing 2.94 per cent of the limestone produced in the entire country. The production of stone for the past ten years is given in the table below.

| YEAR. | Sandstone. | Limestone. | Total. |
|-----------|------------|------------|------------|
| 1893..... | \$ 18,347 | \$547,000 | \$ 565,347 |
| 1894..... | 11,639 | 616,630 | 628,269 |
| 1895..... | 5,575 | 449,501 | 455,076 |
| 1896..... | 12,351 | 410,037 | 422,388 |
| 1897..... | 14,771 | 480,572 | 495,343 |
| 1898..... | 6,562 | 557,024 | 563,586 |
| 1899..... | 17,239 | 792,685 | 809,924 |
| 1900..... | 9,379 | 595,507 | 604,886 |
| 1901..... | 14,341 | 777,484 | 791,825 |
| 1902..... | 10,798 | 662,563 | 673,361 |

GYPSUM.

The gypsum production for 1902 was about the same as for 1901. During the year 143,632 short tons of crude gypsum valued at \$134,726 were produced and sold as:

| | | |
|-----------------------------|---------|-----------|
| Wall cement or plaster..... | 100,314 | \$290,242 |
| Plaster of Paris | 17,865 | 43,593 |
| Land plaster..... | 2,000 | 3,000 |
| Crude gypsum | 600 | 900 |
| | <hr/> | <hr/> |
| Total..... | 120,779 | \$337,735 |

LEAD AND ZINC.

No zinc was produced and marketed in Iowa during 1902. A small amount of pyritiferous ore was mined chiefly in development work but on account of the low prices which prevailed for inferior ores it was not put upon the market. Development work for lead continued to be more active during the year than for a number of years. A number of the old properties are making substantial improvements and new mines are being opened so that a much larger output may be confidently predicted for 1903. The average price for galena was \$23.00 per thousand pounds at the mine and practically all of the lead ore produced in the state was sold to the local smelter owned and operated by Wm. G. Waters. Pig lead sold for \$4.00 per cwt. on the average.

The lead production for the year amounted to 486,000 pounds and sold for \$11,178.

CLAYS AND CLAY INDUSTRIES OF IOWA.

S. W. BEYER.
G. W. BISSELL.
I. A. WILLIAMS.
J. B. WEEMS.
A. MARSTON.

TECHNOLOGY OF CLAYS

BY

S. W. BEYER AND I. A. WILLIAMS.

TECHNOLOGY OF CLAYS.

BY S. W. BEYER AND I. A. WILLIAMS.

CONTENTS.

| | Page |
|---|------|
| The Technology of Clays..... | 29 |
| Chapter I. | |
| Definition | 35 |
| Origin | 35 |
| Classification..... | 37 |
| Ladd's..... | 37 |
| Buckley's..... | 39 |
| Orton's | 40 |
| Primary or residual clays..... | 40 |
| Secondary clays..... | 44 |
| Clays deposited in still water..... | 44 |
| Clays deposited from running water..... | 48 |
| Clays deposited by glacial action..... | 49 |
| Clays deposited by wind | 51 |
| Chapter II. | |
| Composition and Chemical Properties | 52 |
| Kaolinite and pholerite | 52 |
| Clay substance..... | 53 |
| Properties of kaolinite..... | 54 |
| Impurities in clays | 55 |
| Silica | 55 |
| Feldspar and mica | 57 |
| Iron | 58 |
| Lime..... | 62 |
| Magnesia | 65 |
| Alkalis..... | 66 |
| Organic matter..... | 68 |
| Uncommon constituents..... | 68 |

| Chapter III. | Page |
|--|------|
| Physical Properties of Clays | 69 |
| Raw clays | 69 |
| Structure..... | 69 |
| Color..... | 70 |
| Feel | 72 |
| Slaking | 72 |
| Strength | 74 |
| Bonding power | 85 |
| Plasticity | 87 |
| Shrinkage..... | 103 |
| Porosity..... | 109 |
| Specific gravity | 114 |
| Fineness of grain..... | 116 |
| Burnt clays | 123 |
| Fusibility..... | 123 |
| Fusibility defined | 123 |
| Effect of chemical composition on..... | 129 |
| Effect of physical condition on..... | 132 |
| Methods of expressing..... | 133 |
| Methods of measuring..... | 137 |
| Table of Seger's cones..... | 141 |
| Methods of preparing the clay for fusion tests..... | 144 |
| Table showing fusion temperatures for Iowa clays | 147 |
| Chapter IV. | |
| Processes in the manufacture of clay wares | 148 |
| Winning of the raw material | 148 |
| Surface digging..... | 151 |
| Quarrying..... | 152 |
| Mining..... | 155 |
| Transportation of the raw material to the works..... | 156 |
| Preparation of the raw material..... | 163 |
| Dry way | 163 |
| Blake crusher | 163 |
| Rolls..... | 165 |
| Disintegrators..... | 168 |
| Dry pans | 170 |
| Ball mills | 174 |
| Wet method | 175 |
| Wet pan..... | 175 |
| Pug mill | 176 |
| Soaking pit | 177 |

| | Page |
|--|------|
| Screens..... | 179 |
| Inclined stationary..... | 179 |
| Inclined vibrating..... | 180 |
| Dunlap..... | 184 |
| The formation of clay wares..... | 185 |
| Manufacture of brick..... | 185 |
| Soft mud..... | 185 |
| Stiff mud..... | 192 |
| Cutting tables..... | 197 |
| Repressing..... | 202 |
| Dry press..... | 209 |
| Manufacture of drain tile and building block..... | 212 |
| Manufacture of sewer pipe..... | 214 |
| Manufacture of pottery..... | 215 |
| Wedging..... | 216 |
| Jolly..... | 216 |
| Stoneware glazing..... | 218 |
| Salt..... | 219 |
| Slip..... | 223 |
| Bristol..... | 225 |
| Properties of clays used in the manufacture of the foregoing classes of wares..... | 227 |
| Soft mud brick..... | 227 |
| Stiff mud brick..... | 228 |
| Drain tile and hollow block..... | 231 |
| Sewer pipe..... | 232 |
| Earthenware..... | 232 |
| Stoneware..... | 233 |
| Drying of clay wares..... | 234 |
| General consideration..... | 234 |
| Practical consideration in drying clays..... | 244 |
| Types of dryers..... | 247 |
| Outside air drying..... | 247 |
| The hot floor..... | 249 |
| Sewer pipe or slatted floor..... | 249 |
| Periodic or chamber dryer..... | 250 |
| The continuous tunnel dryer..... | 252 |
| Direct..... | 255 |
| By fuel burned for the purpose..... | 256 |
| By waste gases from other processes..... | 257 |

| | Page |
|---|------|
| Indirect..... | 258 |
| Radiation from heated brick work | 258 |
| Radiation from steam heated surfaces..... | 259 |
| Summary..... | 260 |
| Burning of clay wares..... | 261 |
| Combustion of fuel..... | 261 |
| General discussion..... | 261 |
| Practical considerations | 269 |
| Changes which occur in the burning of clays. | 274 |
| Water smoking | 278 |
| Stage of oxidation..... | 280 |
| Vitrification..... | 283 |
| Types of kilns..... | 288 |
| Intermittent kilns | 288 |
| Updraft. | 289 |
| Temporary..... | 289 |
| English clamp | 289 |
| American scove. | 289 |
| Permanent | 289 |
| Direct..... | 289 |
| Rectangular | 289 |
| Round | 290 |
| Pottery | 290 |
| Semi-muffle..... | 291 |
| Muffle | 291 |
| Downdraft | 292 |
| Direct round | 292 |
| Single stack..... | 293 |
| Multiple stack..... | 306 |
| Direct rectangular..... | 309 |
| Single stack..... | 310 |
| Multiple stack..... | 312 |
| Muffle..... | 313 |
| Continuous | 314 |

CHAPTER I.

DEFINITION.

The term clay in its most common usage includes a large variety of substances which, when mixed with water, are said to become plastic, or capable of being molded. The alluvium of river bottoms and the purest kaolins and fire clays are alike called clay. The numerous different varieties of clay differ widely in both composition and physical characteristics but the examination of many clays shows the universal presence of certain constituents which compose the clay base. This clay base is called kaolin or, if the isolated mineral, kaolinite. It is owing to this mineral that clay possesses the property of plasticity which makes it of use to man.

Clay may then be defined as a mineral mixture in which kaolinite is present in sufficient amount to impart to the mass its characteristics to a degree allowing of its use in the manufacture of clay wares. This definition includes all workable clays from the purest kaolin and ball clays to the contaminated shales and alluvium. It would exclude those bodies of argillaceous material which contain impurities to the extent that they are not utilizable in the manufacture of clay products. Under this latter would fall the highly calcareous glacial till and the pyritiferous and bituminous shales.

ORIGIN.

It has been noticed that the essential base of clay is kaolinite, which is a hydrous silicate of alumina. It is not an original constituent of the earth's crust but results from the decomposition of the feldspathic minerals. Expressed in chemical formula, kaolinite is $\text{Al}_2\text{O}_3, 2\text{SiO}_2, 2\text{H}_2\text{O}$, having a percentage composition of Alumina 39.8, silica 46.3, water 13.9. The most com-

mon type of feldspar, occurring in granitic rocks is orthoclase having the composition, $K_2O, Al_2O_3, 6 SiO_2$. This is taken as a type of the group, though the percentage of the acid as well as the alkaline components may vary to a large extent. In other members of the feldspar group, potash is partially or entirely replaced by soda and lime, and hence the numerous varieties or species which are designated respectively as potash feldspars, soda feldspars, and lime-soda, soda-lime, potash-lime feldspars, etc., according as one or another of these bases predominates. Orthoclase is an essential mineral in granitic and syenitic rocks from which many of the kaolins or pure clays of today are known to be derived; so it may be assumed that to the decomposition of this and related silicate minerals is due to a large extent the essential constituent of the numerous varieties of plastic materials used in the ceramic industries.

When the residual material resulting from the decay of granitic rocks remains in the place originally occupied by the rock itself, it constitutes beds of kaolin. This material is sometimes carried for short distances by running water and deposited in lakes or other bodies of water in as pure or purer condition than before such transportation. In this way have originated some of the kaolin beds of the southern states. Much of this disintegrated feldspathic rock substance is carried long distances, is spread over large areas and consequently intermixed, in its deposition, in all proportions with debris resulting from the weathering of different classes of rocks. Such deposits form along the borders of the larger bodies of water becoming beds of shale which on elevation of land surface comprise the most important source of clay for the manufacture of the cruder clay goods.

As soon as these strata become land surface, the agents of weathering begin to act, as on the original igneous rock, to disintegrate and remove all the ingredients amenable to their attack. In this way these clay materials are again worked over, some

portion carried and redeposited in bodies of water, forming secondary beds of clay; a portion is laid down along the courses of streams forming beds of alluvium; and some of the more refractory elements left as a residuum. Thus we see that what is recognized as a clay today is a mixture of different substances that have originated from the decay of rocks of greatly varying character, the parent ledges of which may be in some far distant region.

CLASSIFICATION OF CLAYS.

On the basis of origin and occurrence, Dr. G. E. Ladd has given the following classification of clays:*

INDIGENOUS—

- A. Kaolins
 - a. Superficial sheets.
 - b. Pockets.
 - c. Veins.

FOREIGN OR TRANSPORTED—

- A. Sedimentary
 - a. Marine
 - 1. Pelagic.
 - 2. Littoral.
 - b. Lacustrine.
 - c. Stream.
- B. Meta-sedimentary.
- C. Residual.
- D. Unassorted.

The indigenous group in this classification, as the term signifies, includes those clays which have originated in place and occupy the position of the parent rock. They are usually very pure clays or kaolins containing only those insoluble impurities that resulted from the decomposition of the original feldspathic rock.

* Bulletin No. 6—A Geological survey of Georgia, p. 10.

The foreign or transported clays comprise much the larger group. This group embraces beds of clay which originated by the transportation or removal and sedimentation of the kaolinite minerals from the place of their formation.

The first division of the group, the sedimentary clays, is the most important and comprises all clay strata that have been deposited through the action of moving water. As noted in the outline, the subdivisions under this head are (a) Marine, including (1) Pelagic or deep sea deposits and (2) Littoral or close shore deposits; (b) Lacustrine or clay beds put down in lake basins; (c) Stream, composed of (1) floodplain or alluvial clays and (2) strata of similar nature deposited in the formation of deltas.

The second division of transported clays (B) Doctor Ladd has designated Meta-sedimentary meaning those originating from the decomposition of once transported sediments as tufa, pumice, etc. These are comparatively unimportant.

In the third division (C) Residual, would be placed those clays resulting from the removal of the weathering and soluble constituents of some sedimentary rock in which was included varying proportions of clay materials. Nearly all calcareous and arenaceous beds contain small proportions of clay substance which were transported and deposited as such, and on the removal of the cementing material the clay remains as a residuum. (D) Unasserted, is relatively unimportant in most districts so far as the availability for manufacture is concerned. It embraces those beds which have been deposited by glacial ice. It is commonly a heterogeneous mixture of clay, sand, pebbles and bowlders with no such arrangement as is characteristic of water deposits. The designation "bowlder clay" is aptly applied to deposits of this nature.

Doctor Ladd's classification of clays is to be regarded as very excellent for a general classification. In order, however, to place

an individual bed of clay in this outline it would be necessary to subdivide the members given in his table. This classification would be incomplete for Iowa clays for it fails to comprehend a division which constitutes a very important source of raw materials in this state. While in some instances the loess clays might be included in some subhead of the sedimentary group, as given in the table, it would be advisable when considering the clays of Iowa to make a division of eolian or wind deposits.

Dr. E. R. Buckley, in his report on the Clays and Clay Industries of Wisconsin,* offers a classification of clays which is based, as is the foregoing, upon the genesis of the deposits.

- I. Residual, derived from:
 - A. Granitic or gneissoid rocks.
 - B. Basic igneous rocks.
 - C. Limestone or dolomite.
 - D. Slate or shale.
 - E. Sandstone.
- II. Transported by:
 - A. Gravity assisted by water.
 - Deposits near the heads and along the slopes of ravines.
 - B. Ice.
 - Deposits resulting mainly from the melting of the ice of the Glacial epoch.
 - C. Water. 1. Marine. 2. Lacustrine. 3. Stream.
 - D. Wind. Loess.

In the following scheme which, in the main, is the classification offered by Prof. Edward Orton of Columbus, Ohio, the subdivisions are somewhat more extensive and while the ultimate basis is that of origin, the physical and chemical properties are taken into account in making some of the lesser subdivisions.

*Clays and Clay Industries of Wisconsin. Bulletin No. VII, Part I, Wisconsin Geol. and Nat. Hist. Survey.

| | | | | | | | | | | |
|---------------------------------|---|--|---------------------|---|-------------------------------|--------------------|------------------------------------|--|--|---|
| Primary or residual clays. | { | Entirely decomposed feldspathic rock. | { | Kaolin or China clay. | | | | | | |
| | | Partially decomposed feldspathic rock. | { | English Cornwall stone. Porzellan Erde of the Germans. | | | | | | |
| Secondary or transported clays. | { | Deposited in still water. | { | Fire clays. | { | Highly refractory. | { | Flint fire clay. Plastic fire clay. | | |
| | | | | { | Shales. | { | Moderately refractory. | { | No. 2 fire clay. Stoneware clay. Sewer-pipe clay | |
| | | | { | | Deposited from running water. | { | Alluvium. Sandy clays, Loam. | { | Indurated. Not metamorphosed. | { |
| | | | | { | | | | | | |
| | | { | Deposited by winds. | | { | Unleached. | { | Blue boulder clay. | | |
| | | | | { | | | | Loess. | { | |

Primary or Residual Clays.

The origin of the different groups of the primary or residual clays has been indicated but it may be of interest to inquire somewhat more fully into the changes that take place in the transformation of the original crystalline rock to residual beds of kaolin. In some instances, the process of kaolinization is found in actual operation showing the thoroughly kaolinized stratum above, which passes by scarcely perceptible gradations into the unmodified crystalline granite or gneiss below. Such is observed in the Cornwall quarries in England and in the Brandywine feldspar beds of Pennsylvania.

The changes which occur in the weathering of igneous rocks containing silicates of the alkalis are a series of complex reactions by which the primitive minerals are broken up and part of their

substance dissolved away. The igneous rocks from which kaolinite originates are composed chiefly of the following minerals: quartz, feldspar, mica, hornblende, augite; and often contain various other compounds as accessories, usually silicates. Feldspar is a silicate of aluminum with varying proportions of potash or soda, lime and rarely barium. The feldspar group is a broad one, the separation of the different varieties being based on the alkalis present and on the ratio of the oxygen held by the bases as compared with the oxygen held by the acid element, silica. Thus we have orthoclase, a potash feldspar with a ratio of base to acid of 1:3, the lowest of the series. From this, the most acid of the group, is a series with gradually increasing ratio and varying basic elements, to the plagioclase division in which anorthite, a lime feldspar, has a ratio of base to acid of 1:1.

The micas are silicates of alumina, lime, magnesia, iron, potash and soda in varying amounts. Hornblende and augite are silicates of alumina, lime, magnesia and iron. When these minerals are exposed to the weathering agencies, decomposition takes place, the compounds are broken up or readjusted into combinations more stable under prevailing conditions. The effect of freezing and thawing near the surface is to rend the rock and ultimately to reduce it to the condition of sand. Contemporaneous with this mechanical disintegration are the chemical effects of percolating waters. Most circulating water carries in solution large or small amounts of carbonic and other acids. Thus charged, its solvent power is increased and it attacks to some extent nearly all rock substances, either dissolving the mineral entirely or producing an alteration in its chemical composition. Of the products of this change, the water bears away that which is soluble leaving as a residue the insoluble portions.

Of the constituents of the igneous rocks, the feldspars and iron-bearing minerals yield first to the action of the weathering agents. Their mineral composition is destroyed, soluble com-

pounds of the bases are formed, probably largely carbonates, and the alumina and silica remain as the hydrous alumina silicate, kaolinite, and free quartz. In a similar manner the other basic silicates are decomposed, though less readily. Hornblende yields with more difficulty than feldspar but is known to leave an aluminous residue though probably of different composition from kaolinite. The micas, especially the white variety, muscovite, are comparatively refractory minerals and are very generally present disseminated throughout kaolinitic beds as small plates and scales. So immune to external influences are they that minute mica scales are frequently seen in deposits of limestone and shale, transported, perhaps, long distances preceding deposition. On decomposition, these yield magnesia and iron and an aluminous portion which is not carried away by percolating waters. From the decay of hornblende and mica principally, kaolins are universally more or less iron-stained, and often to such a degree as to render the deposit unavailable as a source of potter's supply. Kaolin deposits are contaminated with iron or free from that element according as they originate from igneous rocks bearing ferruginous minerals or free from the same.

The following comparative analyses of a fresh, unweathered gneissic granite and the decomposition product of the same will show in a general way the relative losses of the different constituents.*

| | —PER CENT— | |
|---|------------|-------------|
| | Fresh. | Decomposed. |
| Silica (SiO ₂)..... | 60.69 | 45.31 |
| Alumina (Al ₂ O ₃)..... | 16.89 | 26.55 |
| Iron oxide (Fe ₂ O ₃)..... | 9.06 | 12.18 |
| Lime (CaO)..... | 4.44 | Trace |
| Magnesia (MgO)..... | 1.06 | 40 |
| Potash (K ₂ O)..... | 4.25 | 1.10 |
| Soda (Na ₂ O)..... | 2.82 | .22 |
| Phosphoric acid (P ₂ O ₅)..... | 0.25 | .47 |
| Ignition (H ₂ O)..... | 0.62 | 13.75 |
| Total..... | 100.08 | 99.93 |

* Merrill: Rocks, Rock Weathering and Soils, p. 215.

That there is a loss of some of the constituents and a proportionate gain in others is clearly proven by many instances, but as to just what the active agents are in bringing about this change, scientists are divided in opinion. Weathering is known to be very effective in bringing about these chemical changes near the surface where it is most active. In some cases, however, granitic rocks are kaolinized to a depth of from 50 to 100 feet. It seems hardly probable that this could have been brought about by the action of descending water, and another theory is advanced to account for such deep deposits. Indeed, some authors would account for all kaolin formation and much of the decay of igneous rocks through the action of ascending acid vapors, or mineralizers, important among which are fluorine vapors. Experiments have shown that feldspar, when exposed to vapors of hydrofluoric acid, decomposes into a silicate of alumina, soluble fluorides of the alkalis, and silica. In support of this theory it may be mentioned that kaolinization takes place at depths beyond which weathering is thought to extend; kaolin is often associated with mineral fluorides; and lastly, unaltered sulfides are found in kaolins which would certainly have decomposed under weathering influences as they are always one of the first to yield. In the laboratory, hydrofluoric acid attacks and decomposes other silicate minerals as well as feldspar. The fact, however, that the micas are nearly always present in residual clays in unaltered condition, constitutes a very vital objection to the fluorine theory. The kaolin beds of Eastern United States are thought not to belong to the fluorine type but are due to surface weathering. In the West, notably in the Cripple Creek region of Colorado, are found kaolin deposits whose origin can be explained only through the action of ascending vapors or liquids. Those of Zettlitz, Bohemia and Cornwall, England are likewise cited as examples of the Cripple Creek type.

Considered as geological agents, the influences that have effected these transformations are at work today as in past ages. We find, therefore, intermediate stages between the crystalline rock and that of complete kaolinization, each particular stage of the gradation being somewhat transitory. Many of the kaolin beds consist of only partially modified grains of feldspar which are more or less protected by the thin coating of the hydrous silicate of alumina that has formed around their exterior. Most kaolins still retain larger or smaller proportions of the alkalis and only a few approach the composition of kaolinite, $\text{Al}_2\text{O}_3, 2\text{SiO}_2, 2\text{H}_2\text{O}$.

SECONDARY CLAYS.

CLAYS DEPOSITED IN STILL WATER.

Beds of rock laid down mechanically in still water consist of the most finely comminuted rock fragments. These fragments have remained in suspension in the water which transported them, through all variations of velocity, until borne into some body of quiet water they were slowly deposited in the order of their size and specific gravity. The great bulk of the argillaceous materials used in the ceramic industries is derived from still water deposits.

Fire Clays.—Fire clay, as the name indicates, designates a clay that will withstand the action of fire. The extent to which a clay will withstand heat, determines whether it will be placed in a classification as a fire clay or as a member of a less refractory group. In a metallurgical sense, fire clays are such as fuse only at temperatures sufficiently high to allow of their use in furnace walls and other positions where they will be subjected to the highest heats used and still retain their form and previous condition, physical and chemical. As the temperatures employed in different metallurgical industries vary to a considerable degree, so in order to meet these conditions, fire clays must vary equally

in refractoriness. If a clay fulfills its purpose when moderate temperatures are employed, it is as truly designated fire clay as are those that stand much more elevated temperatures. Popular usage has, however, broadened or, rather, distorted the significance of the term, and it has come to be applied to all seams of clay found beneath beds of coal. Such usage undoubtedly comes from the fact that some of the best fire clays are found in this position. But it seems best to limit the scope of the term fire clays to those clays which are eminent in fire resisting qualities as shown above.

On the foregoing considerations, fire clays may be divided into highly refractory and moderately refractory.

The highly refractory clays include two varieties, viz., so-called flint or non-plastic fire clays and plastic fire clays. These clays approach kaolin very closely in composition, being almost entirely free from the common fluxes. A percentage of free, finely divided silica is usually present. They are used in the manufacture of glass pots and crucibles, fire bricks and other wares in which the refractory quality is requisite.

The origin of both plastic and flint clays seems to have been similar. Although not always found beneath seams of coal, the best evidence goes to show that these pure clays are residual soils that have supported vegetable growths and from which all materials available for plant food have been extracted. The method of deposition may have been in no way different from that of more impure clays, but they have undergone a purifying process through the action of organisms and the agents of weathering which has left them essentially a hydrous silicate of alumina.

The flint clays are characterized by their stony hardness and their lack of plasticity no matter how finely ground. The cause of this condition is as yet unsolved, but it is thought to be due to the physical rather than the chemical constitution. Wheeler* states that the flinty nature is probably due to alteration by

* Clays of Missouri, page 206.

leaching and a recrystallization of the kaolinite. Orton* also suggests that this characteristic is likely due to incipient crystallization of the clay.

Under these premises and our conception of the flaky, scaly structure of a clay as the chief cause of plasticity, it would appear that a flint clay when finely comminuted should become plastic as do other clays. This secondary crystallization, however, affects the clay as a mass and does not develop individual plates or scales. When ground, it does not consist of small separate crystals but of the powder of one large crystal of kaolinite, so to speak. Accepting the thin plate theory of plasticity, it is believed that there is a possible explanation along this line.

The plastic fire clays differ little in composition but are less refractory than the flint clays. In use, it is evident that some bonding clay must be employed with the flint clays, for, because of their lack of plasticity, it would be impossible to use them alone. The flint and bond clays are in this way necessarily used in conjunction, the former possessing the better heat-resisting qualities, the latter furnishing the bond which holds the ware intact.

No Iowa clays have as yet been exploited that have the requisite composition for a No. 1 fire clay. Most coal seams are underlain with fire clay, as the term is popularly used, and in some cases these clays are employed in the manufacture of fire brick, but the ware is of an inferior grade. It is highly probable that Iowa possesses good fire clay beds not yet discovered which sooner or later will be utilized.

The moderately refractory fire clays include those clays which stand a sufficiently elevated temperature to be used in the manufacture of the classes of ware which require a salt or natural slip glaze. The degree of heat necessary in the use of salt as a glaze is at least 2000° F. Temperatures from 2200° up are

* Geology of Ohio, Vol. VII, page 53, 1893

required for slip and Bristol glazes. Wheeler* sets the limit which a clay must stand without melting to merit the name "fire clay" at 2500° F. As many sewer pipes burnt at salt glazing temperatures are more or less vitrified, it is probable that Wheeler's standard of 2500° will need to be lowered slightly to include this class of ware.

Clays of this class are obtained almost universally from the Coal Measures, commonly the under clays. In derivation they do not differ from the more refractory clays, their principal variations being the presence of larger proportions of the fluxing impurities, especially iron. Plant action has not thoroughly removed all impurities, or the impurities may have been brought in and left by water carrying them in solution.

Shales.—The shales compose much the larger amount of the materials used in the manufacture of clay wares. They consist of a mixture of the residual minerals from the decay of all classes of rocks. Shale beds are always stratified and are usually compact and somewhat slaty in structure. Where unexposed to weathering influences, a distinct slaty cleavage is often present indicating an advanced stage of induration or incipient metamorphism.

The shale clays are not commonly plastic clays, but when finely ground or subjected to weathering processes they become very plastic. Their plasticity is latent. A breaking down of their more or less indurated structure by one of the above processes is necessary in order that a mixture with water will develop this requisite property.

The slaty shales are those which have lost a proportion of their water or hydration through the metamorphosing action of heat and pressure. All degrees of transition exist, from the readily plastic shale to the anhydrous slate. Such slaty shale, when used in conjunction with the plastic varieties, serves the

*Clays of Missouri, page 26.

purpose of sand or grog in lessening shrinkage, but it has no bending power.

Bituminous and carbonaceous shales are those which still contain a percentage of the organic or carbonaceous matter that was deposited contemporaneously with them. They usually have a compact structure, dark color and even a bituminous odor. When employed in the manufacture of clay goods, they furnish a portion of the fuel necessary in burning, and a kiln of ware, when heated, is frequently allowed to stand for several hours without the addition of any combustible until the contained carbonaceous matter of the clay is consumed.

The term "clay shale" is meant to designate those shales which in themselves are utilizable for the manufacture of clay products. A bituminous or calcareous shale must be mingled with some purer variety as a diluent to be successfully used. The non-plastic shales are used with more plastic materials. The great bulk of the shale strata that are used in clay manufacture is such as is not characterized by the preponderating presence of any one impurity. The amounts of those that are present are not sufficient to hinder its use alone in the manufacture of any given class of ware. To these the term "clay shale" is applied.

The shales of Iowa belong largely to the Coal Measures, but valuable beds are also found in the Devonian strata.

DEPOSITED FROM RUNNING WATER.

Alluvium.—The bodies of silty material that are found along most of the older streams of today are known as alluvium. They consist of interstratified layers of sand and fine gravel and silt, often attaining great thicknesses. These deposits are put down by the streams during periods of high water, when they overflow their banks and sometimes flood large areas. The character of the deposit evidently depends on the material carried as well as on its physical condition, fineness of grain, etc.

Oftentimes the material is of such a nature that it is usable in making some of the cruder clay wares. It often possesses a high degree of plasticity but is usually accompanied by an excessive shrinkage in drying. While the one quality is quite necessary, the other is frequently the inevitable hindrance to the use of alluvium as a clay supply.

Loam.—In regions covered with drift or glacial till deposited by continental glaciers, the lowland soils are spoken of as loam. Their derivation is from the hills and plateaus of drift from which they have been gradually accumulated in less elevated or sloping positions. They consist of partially decayed and weathered material from the higher slopes that, when loosened, is carried downward to lower levels. Loam in composition is little different from the river alluvium of glaciated countries, being made up of the debris of weathered rocks which has been subjected, to some extent, to the action of plant life. It is usually dark, sometimes black, in color, not very plastic when wet, and although commonly intermixed with considerable sand, shrinks largely in drying and does not produce a strong clay body.

Loam is used in some localities for brick and tile making. It burns a deep red color but will not stand a high temperature.

DEPOSITED BY GLACIAL ACTION.

Boulder Clay.—As previously mentioned, the name boulder clay is applied to the heterogeneous deposit spread over a great portion of the country by sheets of moving ice. Whether or not such a deposit contains sufficient of the clay element to be of use as a source of supply depends upon the region from which it has been transported. Where the ice has passed over areas whose country rock is largely shales, the final deposit will be in large part argillaceous material. Instances are not lacking where large masses of shale strata, as well as of other rocks,

have been bodily carried for some distance and dropped in a practically undisturbed condition. But the bulk of the clay constituents of the drift is pulverized and thoroughly kneaded together with the rock meal of other strata.

Besides the finely powdered rock substance the drift commonly contains numerous bowlders, large and small, and pockets of sand scattered promiscuously throughout. It is only in exceptional instances that drift is sufficiently free from bowlders and high enough in clay substance to be used for clay manufacture. It is sometimes possible, where the bowlders are comparatively few, to remove them by hand picking, but this method is seldom profitable. The nearly universal presence of fragments of limestone is often an effective hindrance to the use of deposits of bowlder clay for making clay products.

In newly-opened banks of this character, and especially in the deeper portions of the bank, the clay has ordinarily a bluish shade. This is due in large part to the fact that the contained iron compounds are predominatingly ferrous. Near the surface of such a bank weathering and percolating waters have altered these lower compounds of iron to the ferric condition, which change is largely responsible for the yellow or reddish color in these parts. In the older drift regions leaching has progressed to greater depths, and a section of considerable thickness may show a state of thorough oxidation, the entire mass being iron-stained to a yellow or reddish cast. Further than the mere oxidation of the attackable compounds, the leaching process removes some of the soluble constituents whose presence in the clay would be detrimental to its economic use. In these respects, therefore, the weathered and leached glacial till is in a better condition to be employed in manufacture than the blue, unmodified deposit.

Many of these clays are very plastic and workable, and in some places they are used to a considerable extent in the brick

and tile business. They are quite strong and their shrinkage is not excessive. The most serious drawback to their more extended use is their heterogeneous composition.

DEPOSITED BY WINDS.

Loess.—Over large areas in the Central United States occur deposits of a calcareous, silty material, the so-called *loess* of the Germans. In some places the loess is at the surface and in part responsible for the topography. It is, however, often found intercalated between two of the newer drift sheets. The loess in the stratigraphic column of Iowa appears to bear a constant relation to one of the later sheets of till and this relation is thought to be genetic. Its derivation from the till is not fully understood or, at least, not agreed upon by geologists. According to one theory, accumulation was brought about by quiet deposition in extensive lake beds existing during the closing stages of the glacial period. A second theory, and the one that appears to answer more fully, perhaps, many of the questions connected with the so-called "loess problem," is that of its accumulation by winds. Under this hypothesis, these immense and irregular heaps of finely comminuted rock detritus were formed by wind-drifting from the recently ice-vacated areas of drift deposits.

The loess consists of only the finer particles occasionally interspersed with streaks of sand. Stratification is usually absent, sections of fifty or more feet often showing no break in the continuity of the deposit. Vestiges of stratification lines are frequently observed, but assuming such directions as to be scarcely accounted for by water deposition. Examination with the microscope shows the constituent particles to be mostly angular and to range in size from .1 mm. in diameter to impalpability not measurable with the highest power of the microscope. Practically all of the particles pass readily through the 150-mesh

screen. Mixed with water, loess is worked with difficulty and develops very imperfect plasticity. It is short and hard to mold and to dry safely.

Loess is used in Iowa at numerous points for brick manufacture with a success varying from indifferent to excellent, depending on the process employed. The largest deposits of loess clay are coextensive with the larger river valleys of the state and the principal plants making use of it are located along these streams.

CHAPTER II.

Composition and Chemical Properties.

As shown in Chapter I, the essential components of clay are silica, alumina and water in chemical combination, a hydrous silicate of alumina. That kaolinite is the only hydrous silicate of alumina in clays is questioned by some writers from the fact that some of the purer varieties, as the flint fire clays, show a higher percentage of alumina than is contained in kaolinite. Wheeler* quotes analyses of Missouri flint clays which run as high as 43 per cent of alumina. Pure kaolinite, as given on a preceding page carries only 39.8 per cent.

The presence of pholerite, a more highly aluminous silicate has been proved for some Missouri flint fire clays and New Jersey fire clays. Pholerite has the composition:

| | |
|--|------|
| Silica (SiO_2) | 39.3 |
| Alumina (Al_2O_3)..... | 45.0 |
| Water (H_2O)..... | 15.7 |

The chemical formula expressing this composition is $2\text{Al}_2\text{O}_3$, 3SiO_2 , $4\text{H}_2\text{O}$. The excess of alumina in the clays mentioned

*Clays of Missouri, pp. 50-51.

is explained by assuming the presence of a mixture of pholerite and kaolinite.

In ordinary shales and alluvial clays the proportion of the non-essential constituents or impurities is so large that, by analysis, it is usually impossible to detect the existence of, or distinguish between, these two minerals. Their composition and properties are all very similar, and this portion of the composition of a clay is commonly spoken of as clay substance. It may be said, then, that in the components of a clay are included the clay substance, or plastic constituents, and the impurities, or non-plastic minerals. Each of these exerts its own individual influence on the behavior of a clay. The amount and character of the impurities determine largely the use to which a clay may be put. Brief consideration will be given to the common impurities found in clays and the effects of such impurities on utilization.

Clay substance is essentially the hydrous alumina silicate, kaolinite, or in chemical analysis, it is that portion of a clay soluble in hot sulphuric acid and sodium carbonate. This commonly corresponds fairly well with the formula of kaolinite. The percentage amount in various clays runs from practically pure kaolinite in the flint clays and some kaolins, to as low as one or two per cent in alluvial and lake clays, as determined by the rational analysis.

Pure clay substance constitutes one of the most refractory of minerals. It is a residuum from the weathering of mineral compounds, and is itself almost unattacked by this influence. The term refractory, however, as used in the metallurgical industries, means the ability of a material to withstand high temperatures. In this sense, kaolinite is considered invincible or as an infusible substance. It, therefore, is the heat resisting element of clays. All the accessory mineral substances found in clays serve in the capacity of fluxes and lower the fusing point of the kaolinitic base.

Kaolinite becomes $\text{Al}_2\text{O}_3, 2\text{SiO}_2$, when subjected to dehydration temperatures and melts only at an excessively high heat. This formula expresses the composition of Seger cone 35, which softens at 3326°F. , or 1830°C. , a temperature somewhat above that necessary to melt platinum. Alumina alone is melted only in the electric furnace, and requires a higher temperature than silica. Mixtures of these two oxids vary in fusibility with the proportions of each present. Additions of silica to alumina lower the fusion point until a mixture with the molecular proportions $\text{Al}_2\text{O}_3, 17\text{SiO}_2$, has been reached. This is the most fusible admixture of the two substances. Up to this point silica acts as a flux. Further increment in the silica content causes the resulting mixture to become less fusible. For instance, $\text{Al}_2\text{O}_3, 20\text{SiO}_2$ would stand a higher temperature before fusion than $\text{Al}_2\text{O}_3, 18\text{SiO}_2$. The influence of the silica has reached its maximum, beyond which point it continues to approach the true melting point of free silica, which, however, is not so high as that of alumina.

Water is found in all clays in two conditions: as **mechanical** moisture; as **chemically combined** water. When clay comes from the bank, it may contain even 40 per cent of water. After it has dried in the air, it still holds a small amount known as **hygroscopic water**, all of which is not expelled below 212°F. Clay heated to this temperature and allowed to stand in the open air will again absorb water approximately equal in amount to what it formerly contained when air dry. The percentage of hygroscopic moisture ranges from .5 per cent in open textured clays to 3 or 4 per cent in clays of a denser texture.

All clays contain water in chemical combination. Kaolinite is a hydrous mineral having nearly 14 per cent of water. There are also other hydrous minerals usually present which carry more or less of combined water, notably limonite.

The removal of the water of combination requires more than drying temperatures. It is largely expelled at a low red heat, about 1100° F., though small amounts still linger in large pieces of ware for one hundred degrees or so higher temperature.

The non-essential components of clays, or the impurities, may be classified as follows:

| | | |
|--------------------|---|---|
| Silica | { | Combined with bases in feldspar, mica, etc. |
| | { | Free silica or quartz sand. |
| Feldspar. | | |
| Mica. | | |
| Iron | { | Silicates—hornblende, augite, etc. |
| | { | Ferric hydroxid. |
| | { | Ferric sulfid. |
| | { | Ferrous carbonate. |
| | { | Menaccanite. |
| | { | Magnetite. |
| Lime | { | Silicates—oligoclase, anorthite, etc. |
| | { | Precipitated carbonate. |
| | { | Limestone fragments. |
| | { | Soluble sulfate. |
| | { | Phosphate. |
| Magnesium | { | Silicates—mica and some feldspars. |
| | { | Carbonate. |
| | { | Sulfate. |
| Alkalis—Silicates. | | |
| Organic matter. | | |

SILICA.

It has been shown that silica is a constituent of kaolinite and its action when raised to high temperatures has been considered.

Silica is also present in clays as a constituent of the other silicate minerals, feldspar, hornblende and mica. These are silicates of the alkalis, alkaline earths and iron. Silica acts in these minerals in its normal capacity of acid. Its melting point is much lowered depending upon the proportions of the fluxing ingredients present.

The percentage of silica in clays of such silicate minerals is variable, ranging from a fraction of a per cent in pure varieties to 25 per cent in low grade clays. It is very difficult to determine the amount present in this condition by chemical analysis. Chemical methods will separate the free quartz sand from the

silica combined as kaolinite and mica, for these minerals are soluble in hot sulfuric acid. Feldspar is not affected to any degree by this treatment. By means of the so-called "rational" analysis, however, combined silica is assigned to these different minerals in proportions depending upon the amounts of the alkalis present. The alkalis are considered to be derived from feldspar, and by employing the ratio commonly existing between silica and the bases in typical feldspar, the approximate percentage of this mineral may be calculated. This method of analysis is largely employed with the higher grade clays used in the manufacture of classes of ware where body mixtures of clays are required and where it is necessary to maintain accurate control of the composition.

Free silica or quartz sand is one of the most abundant constituents of clays. It occurs in disseminated grains of varying size, from those that are recognizable with the eye to the finest "grit," the presence of which can only be ascertained by testing the clay between the teeth or examining it under the microscope. Sand is found in all clays in amounts from 1 per cent to 50 and 60 per cent in some shales and kaolins.

Sand exerts both a physical and a chemical influence on a clay. It acts as a fluxing ingredient, and also tends to decrease shrinkage.

There is a prevailing idea that since quartz alone is infusible, the fusibility of any clay to which it may be added will be decreased. For those clays that contain high percentages of the common fluxes and an already high percentage of silica in proportion to alumina, this will hold true. Any addition of silica to such a clay will render it less fusible. This would include all ordinary brick clays. The effect of silica, however, on a highly aluminous clay, as kaolinite, low in fluxes, is to lower its melting point. A siliceous clay can never be highly refractory in the strictest use of that term.

Sand is often added to clays to decrease shrinkage. This it accomplishes by producing a more open texture. The sand grains themselves, which do not shrink, occupy space which without the sand would be filled with clay that now shrinks only around the grains. The form of the ware is better preserved and cracking often prevented by the use of small amounts of sand.

Sandy clays are often found that without the sand would be desirable for some classes of manufacture. On this class of clays, washing has been practiced to some extent but with little success. Unless the sand is quite coarse, this means of removal is not practicable. Further, the feldspar grains which are not distinguishable from quartz sand are likewise removed in the washing process.

FELDSPAR.

Feldspar occurs in clays in small rounded or angular grains. It cannot commonly be differentiated from quartz sand but has a very different effect on the clay. Feldspar serves the function of sand or "grog" in the prevention of shrinkage unless the clay be subjected to a sufficiently elevated temperature to cause chemical union. It then becomes a powerful flux. Feldspar melts to a clear glass at 1100° to 1200° C., and being a silicate of the alkalis is very detrimental to the refractory qualities of a clay. Its slow fusion favors vitrification and makes it a desirable ingredient in paving brick clays.

MICA.

Mica is found in most clays. It exists in minute scales and plates and is very slowly affected by weathering influences. The micas are silicates of alumina and iron and the alkalis, and very commonly contain magnesia. Because of a higher percentage of alumina they do not fuse as readily as feldspar but are never-

theless active fluxes at slightly higher temperatures. Their presence is also detrimental to the color of a light burning clay, on account of the small percentage of iron which they usually carry. The percentage of mica in clays is seldom large enough to be of any harm.

IRON.

As indicated in the outline, iron occurs in clays in several different forms. Clays may contain iron in one or numerous combinations, but it may be said to be universally present in some form in all clays and in appreciable amounts. Iron is the most important coloring agent in clays, hence its presence and amount may in many cases determine largely the value of a clay.

The whitest of clays carries .25 per cent or more of iron. Fire clays sometimes analyze as high as 6 per cent. Shales, alluvium and glacial clays are so interrelated that the percentage of iron runs about the same, ranging from 2 to 15 per cent expressed as the peroxid, Fe_2O_3 . A very small amount of iron exists in clays in silicate combination, as in hornblende, augite and biotite. The iron thus contributed, however, is so small usually as to be inconsiderable, not over one per cent at the outside. Iron as ferric hydroxid, $\text{Fe}_2\text{O}_3 + (n \text{ Aq})$, is more commonly present than any other form. It is this compound which gives largely the reddish or brown coloration so often noticed in clays. This compound of iron is the final result of the action of the agents of disintegration and weathering on other iron compounds. $\text{Fe}(\text{OH})_3$ occurs in two conditions: (1) finely divided as it was precipitated from solution during the deposition of the clay substance; (2) in the form of concretions.

From the method of deposition of the precipitated oxid it is widely distributed as minute particles, and as such is able to exercise its maximum effect on the clay. On burning, the combined water is lost, and the iron takes on the familiar red color

of the common brick. It is to this form that most of the iron effects in clay wares are due.

The concretionary hydroxid is not so common as the preceding form, though it occurs very frequently. This form is due to chemical concentration or segregation of the iron particles during or following the deposition of the clay. In some instances they may result from the oxidation and hydration of other concretionary iron compounds. It is often possible to remove many of these concretions by hand picking in the handling of the clay. They produce effects on the ware by giving it a blotched appearance, and where the ware is burned to vitrification fragments of iron of this character will not amalgamate into the body as do the finely distributed particles, hence they leave a roughened surface.

In the burning of clay containing ferric oxid no further change in the iron ordinarily takes place beyond the loss of water of hydration. If the heat is carried high enough for vitrification, and the kiln is frequently allowed a period of reducing atmosphere, i. e., with little draft and full of smoke, the state of the iron is apt to be changed to the ferrous condition. Fe_2O_3 , or the red oxid, will be reduced to FeO . Combinations between Fe_2O_3 and silica are thought not to take place so as to form a ferric silicate. On reduction to FeO , which is a violent flux, silicate combination does occur, forming the brown, black or greenish glassy portion so common on the surface of paving brick and unglazed sewer pipe. Often the bricks are well vitrified and still remain of a red color. It is believed that in this vitrification the iron oxid has not entered into combination as a flux but is merely in solution in the vitrified mass.

Ferric sulfid or pyrites is a common constituent of clays, as well as of nearly all other classes of rocks. In the older formations it is found most abundantly. It occurs in the form of concretions large and small and in crystals often so small that their

presence is undetected without the use of a lens. Commonly it appears in sparkling yellow grains known to the miners as "shiners" or "sulfur."

The chemical formula is FeS_2 . Under weathering influences it changes very readily by oxidation to FeSO_4 , especially if it is in the form of marcasite. Ferrous sulfate is quite soluble in water and may be carried away in solution or, in the presence of other bases, as lime or magnesia, easily breaks up and becomes $\text{Fe}(\text{OH})_3$, ferric hydroxid.

Beds of clay contaminated with iron pyrites can often be utilized to much greater advantage by subjecting the clay before use to a process of weathering. The clay should be blasted down and loosened up, so the rain waters may penetrate it, and then allowed to stand for six months or so. This length of time will be found sufficient to do away with much troublesome iron sulfid as well as other soluble substances.

When heated, FeS_2 loses one molecule of S at about red heat and becomes FeS. As the heat rises, FeS is oxidized to FeO and SO_2 , the latter, being a gas, ordinarily passes out with the other combustion gases. In the presence of steam and any compound, as Fe_2O_3 , capable of reduction, SO_2 may be oxidized to SO_3 , which, with steam, becomes sulfuric acid. Any substances in the clay, such as magnesium, or lime carbonate, that are susceptible to combination with this acid, are attacked, and salts are formed on the surface of the ware. The same result may be brought about by sulfur in the coal. These two, along with the soluble materials which the clay itself may contain, constitute the important sources of whitewashed or "saltpetered" ware.

After oxidation of the iron to FeO, this compound either goes into combination with silica, becoming the black ferrous silicate, or, if the kiln atmosphere be oxidizing, may be further oxidized to Fe_2O_3 , in which condition it does not act as a flux. Its distribution in crystalline grains makes iron sulfid objectionable as

they appear on the finished product as blotches of slag or specks of iron stain.

Clays contain ferrous carbonate, FeCO_3 , in two forms, precipitated and concretionary. The precipitated carbonate is distributed in the clay in minute particles deposited contemporaneously with the settling of the clay itself. To the raw clay it imparts a blue or slate-gray color when present in considerable quantity. It is most common in shales. The presence of iron carbonate may be detected by testing with warm hydrochloric acid. Effervescence indicates the presence of a carbonate.

The clay-iron stones so common in the Coal Measures are largely composed of iron carbonate. Nodules of this material vary from a fraction of an inch to a few feet in diameter. Often they are partially modified to iron peroxid or hydroxid, which change is evident by the red or brown color. The formation of iron concretions is not fully understood. Examples of the segregation of minerals from a matrix in which they were originally disseminated in fine particles are very common. Such accumulation seems to be due to some inherent property which mineral substances possess of attracting to themselves particles of like composition. The formation of concretions of this sort is a process of concentration.

The nodular carbonate may be removed largely by hand picking or washing, but that chemically precipitated and scattered throughout the body of the clay can only be removed by digestion with acid. This method is too expensive to be put in general practice.

Pyrometrically iron carbonate is hostile to refractoriness. It works as a strong flux, as do other ferrous compounds. When heated it loses CO_2 and is reduced to FeO . The latter, on a further rise of temperature, is either oxidized to Fe_2O_3 when the increase in heat is sufficiently slow, or with a rapid increase enters into combination as the dark ferrous silicate, $\text{FeO}, 2\text{SiO}_2$.

Both menaccanite, $(\text{TiFe})_2\text{O}_3$, the titanate of iron, and magnetite, Fe_3O_4 , exist as scattered crystalline granules in many igneous rocks. In the decomposition of these rocks, the iron minerals frequently resist the decomposing agencies to such an extent that clays often contain them in their original crystalline forms. Their amount, however, is small, seldom in large enough quantities to make their presence manifest by any influence on the clay in burning. Menaccanite is the more resistant to weathering and is commonly found scarcely at all changed. Fe_3O_4 weathers slowly, being ultimately modified to the hydrated sesquioxid which imparts a red or brown color.

Metallic iron does not exist naturally in clays, though once in a while such articles as bolts, nuts, nails, etc., find their way into the kiln. At high temperatures the results of their presence are quite disastrous. To melt iron requires at least 1500°C ., or 2732°F ., which temperature is seldom reached in burning kilns. Melting a piece of iron is not alone accountable for the fact that it sometimes leaves a blemished piece of ware by its slagging and fluxing action. Instances are not wanting where a large iron fragment has penetrated several layers of ware leaving in its wake as the indelible mark of its presence a slagged and sintered mass. When iron is exposed to highly heated oxygen-carrying gases, a scale of oxid forms on the exterior which is largely Fe_3O_4 . This oxid fluxes the clay in immediate contact, and the two processes, oxidation of the iron and silicate formation, continue together until the iron is consumed. In this manner a piece of metallic iron is able to work its way through a body of clay.

LIME.

Compounds of lime are very frequently met with in nature. Their importance in clay working operations is great, for, as with iron, the presence or absence of lime in a clay often decides

the use to which it may be put. Large amounts of lime, along with other fluxing bases, are detrimental to a paving brick clay. A similar amount in clays low in other fluxes, used for the manufacture of grades of ware requiring unusually high temperatures, is also undesirable. Lime is a deleterious constituent.

Of the silicates, some of the feldspars most commonly include lime in their composition. Oligoclase and anorthite are the common varieties which carry lime and they are found usually in clays. The proportion of lime contributed by silicates is low, seldom exceeding 1 per cent. The presence of lime in this form is difficult of detection, though it is possible to obtain a fairly accurate estimate of the feldspar. Feldspar in clays is a fluxing ingredient, the higher in bases, alkalis and alkaline earths, the more powerful does it act in this capacity. In this state of combination lime acts with the other fluxes to render a clay more fusible.

Calcium carbonate is a normal constituent of many clays. In such instances it was deposited by precipitation from the ocean waters and is incorporated throughout the clay strata in a finely divided condition. Its presence can ordinarily be detected by testing with cold dilute HCl. Through processes of concentration, these particles are often gathered into the form of concretions. The method of accumulation is probably one of solution, as lime carbonate is quite soluble in acid waters. Lime is found in some glacial clays and very frequently in the loess, in nodular, sometimes tube-like forms, so common to the latter formation as to be known as loess mäunchen or loess püppchen, from the Germans. Small tubes of CaCO_3 often surround plant rootlets as though these had served to excite accumulation round them. In glacial clays principally, also to a lesser extent in alluvial clays, fragments of limestone abound. These are at times difficult to contend with, as they can only be removed by slumming, which is usually impracticable. These limestone particles must be

very finely ground or they produce injurious effects on the manufactured product.

In the finely divided condition, lime carbonate is most harmful to refractoriness. It loses CO_2 when heated, the loss commencing at about 900°C . It is thus left in the condition of quick lime and susceptible to silicate combination with advancing heat. Whether or not lime in this condition exerts a fluxing influence depends on its relative proportion to the other bases in the clay. A shale in order to be used for the manufacture of vitrified wares should not contain much lime. Shales are usually high in the other fluxing impurities. When the requisite temperature is reached the fluxing action of lime is very rapid and a kiln of brick may be melted into a shapeless mass with an increase of only 50° to 75°F . Excepting magnesia, the other fluxes are less rapid in action and are always preferable where the largest possible range is to be had between vitrification and fusion. Where clays containing lime carbonate are not burnt to vitrification, and especially where the carbonate exists in the concretionary form, great harm may come from the slaking of the caustic lime after the kiln is opened. The CO_2 is driven off early in burning and the chemical combination of the moisture of the atmosphere or of rains, where the brick are stacked in the open, form calcium hydrate, $\text{Ca}(\text{OH})_2$, which produces chipping, swelling and bursting.

Calcium combined as the soluble sulfate, gypsum, is very common in the shales and clays of the older formations. It is usually crystalline, though also occurring in grains and crystalline masses. Gypsum is so soft as to be readily scratched with the finger nail, and in this way may be distinguished from calcite which it in some respects resembles. By its hardness, and also by its crystalline form, it may be told from mica or "is-glass," a term that is commonly although incorrectly applied to this mineral. The sulfate is probably largely formed in clays

by the action of sulfuric acid, resulting from the decomposition of iron pyrites, on the carbonate of lime. Calcium sulfate is somewhat soluble and may be deposited or removed by percolating waters. Chemically, gypsum is $\text{CaSO}_4, 2\text{H}_2\text{O}$. Part of the water of hydration is lost at a low temperature, beginning at 100°C . Plaster of Paris is manufactured by calcining gypsum at a slightly higher temperature. At 500° all water is lost and dead-burnt plaster results. At a high heat, SO_3 is given off, which leaves CaO . In the presence of the acid silica, such decomposition is facilitated, and the lime goes into silicate combination. It is the evolution of SO_3 from calcium sulfate that may account for some swelled or puffed brick, especially those that have been carried to softening in burning. Any gas set free after the outer portions of the pieces of ware have begun to fuse will encounter difficulty in passing outward through the now non-porous body, and may be the cause of swollen ware.

On mixing clay with water, some of the soluble sulfate is taken into solution. When this water is evaporated in the dryer, such soluble matter is carried to the surface of the ware and there remains, its appearance only intensified after burning. Calcium sulfate is a very usual cause of the white efflorescences so frequently noticed on brick walls.

MAGNESIUM.

Magnesium occurs in clays in compounds analogous to those of calcium. It is a constituent of some micas but is seldom present in this condition in proportions high enough to affect the behavior of a clay. In silicate combination it acts as a flux, though not so violent a one as lime.

In the form of the carbonate, magnesium is most frequently present. Dolomite, the double carbonate of lime and magnesia, is its common occurrence. As with lime, this mineral is both finely divided and disseminated, or in crystals and concretion-

any masses. Dolomite is soluble in hot HCl, but it is not possible to utilize this as a means of removal.

A hydrous sulfate of magnesia sometimes exists in clays where much iron sulfid is present. Sulfuric acid generated through the decomposition of the latter attacks compounds of magnesia, especially the carbonate, forming the sulfate. Magnesium sulfate, or Epsom salts, is very soluble and may often be detected by the tongue. In well weathered and leached clays this compound seldom exists, and clays from less exposed strata may be freed from it by a process of weathering.

Under heat the behavior of the magnesian minerals is very similar to that of the corresponding compounds of lime. Magnesium is, however, not so severe a flux at high temperatures as is lime. The sulfate of lime and magnesium are, on account of their ready solubility in water, the two most common causes of efflorescences in clay wares.

ALKALIS.

The alkalis, soda and potash, occur universally in clays and most commonly in silicate combinations, as feldspar, less frequently as mica. The total alkalis vary from .5 to 10 per cent in Iowa samples. Wheeler has pointed out in his "Clays of Missouri" the significance of the presence of the alkalis in determining the predominating species of feldspar in clays. Clays high in soda and relatively low in potash probably contain largely the soda feldspar, cligoclase, albite or labradorite. Likewise, those relatively high in potash contain orthoclase, which is an alumina silicate of potash. Analyses usually show both potash and soda indicating the simultaneous occurrence of the different varieties of feldspars in most clays. Through processes of weathering these compounds are gradually broken up, the alkalis taking the form of soluble salts, sulfates, carbonates and chlorids. Small amounts of them are always present, but commonly so small as

to be inappreciable in their effects upon the clay. Where drainage is imperfect, soils and clays are not leached free from the soluble constituents and the salts accumulate. In this way are caused the "alkali" lands of portions of the central and western states.

In silicate combination, as feldspars, the alkalis are injurious to the refractory qualities of a clay depending on the fusibility of the feldspar. Orthoclase, the potash feldspar, fuses at Cone 1 and would exert its full influence as a flux at a temperature a little higher than this. The soda varieties are even more fusible than the potash and would come into effect at lower temperatures. Their action, however, at fusion temperatures is mild, softening taking place slowly. In contrast to lime, whose action is sudden and rapid, the feldspars are favorable to vitrification, and in clays used in the manufacture of vitrified wares, paving brick, sewer pipe and pottery, feldspar is an essential ingredient. That there be a considerable interval between the temperature of softening or incipient vitrification of a clay body and complete vitrification or incipient fusion is a necessary requisite in the burning of all vitrified wares. The longer this interval the better. It is desirable, then, to have in the clay the fluxing elements which best meet these conditions. As has been pointed out, the presence of much lime is detrimental to this property, and kilns of ware made of limy clays are occasionally ruined by carrying the heat a few degrees too far. The feldspars are the most common fluxes as well as the most readily controllable in their action. They produce a dense strong body on vitrification and since they evolve no gas in fusion, never alone cause puffing or blowing of the wares. The soluble alkaline salts are the most effective in fluxing capacity, as they melt mostly at or below red-heat. Their quantity is so small that any effect produced by them is seldom noticeable.

ORGANIC MATTER.

Many clays, and especially the shales, contain organic matter in amounts varying from a fraction of 1 per cent to 8 or 10 per cent. It is finely divided as deposited from suspension in water; or in fragments of carbonaceous material representing probably the remains of swamp vegetation. The colors imparted by organic matter are blue or black and varying shades of brown and red. The presence of iron and other minerals is sometimes masked by the prevailing color of organic matter. Frequently clays of reddish shades, apparently highly iron-stained, show on analysis very low percentages of iron. These clays derive their original red color from contained organic matter and after burning display the true color determined by their mineral constituents. Most organic matter is lost at about red heat in burning. It thus is fuel that instead of being shoveled into the fire holes is intermixed with the clay and burned in immediate contact with the particles of clay which are to be affected by the heat of combustion. For this reason, where a considerable amount is present, it becomes an important source of heat generation; but it becomes available at a temperature in the progress of the kiln where very slow increase is imperative. In this regard organic matter is sometimes the cause of annoying difficulties.

UNCOMMON CONSTITUENTS.

The occurrence of titanium as titanate of iron, ilmenite, has been noted. Titanium rarely occurs in needle like crystals as the mineral rutile, TiO_2 . Its influence in a clay is not fully determined and in chemical analysis it is usually weighed with the silica. Its effect when added in small quantities to pure kaolin and burnt is to produce a slightly yellowish body. In increased amount, Seger has shown that it produces a body of bluish tint when burnt to sintering. Because of its rare occurrence, it is not an element of importance.

Manganese as the oxid, pyrolusite, is very rarely found in common clays and shales. In some of the so-called slip clays for glazing, it is present in appreciable quantity.

Alum occasionally exists in clays from the action of the sulfuric acid of decomposing iron pyrites on aluminous minerals. It is readily soluble in water and does not occur in leached clays. When present in appreciable amounts it renders the clay more fusible.

CHAPTER III.

Physical Properties of Clays.

In studying the clays of Iowa, the following physical properties have been investigated, a knowledge of which is believed to be important to the clay worker. They are listed according as they apply to the clay in the raw or the burnt state. Corresponding terms applicable to both the raw clay and manufactured product are discussed together.

| RAW CLAY. | BURNT CLAY. |
|--------------------|-------------------|
| Structure. | Structure. |
| Color. | Color. |
| Feel. | Strength. |
| Slaking. | Shrinkage. |
| Strength. | Porosity. |
| Bonding power. | Specific gravity. |
| Plasticity. | Fusibility. |
| Shrinkage. | |
| Porosity. | |
| Specific gravity. | |
| Fineness of grain. | |

STRUCTURE.

The structure of a deposit of clay is of importance since on it depends the means employed in removing the clay from the bank and in preparing it for the molding process. Clay structures are slaty, shaly, jointed, laminated or concretionary when viewed *en*

masse in the pit. These characteristics are all more or less indicative of the changes which the clays have undergone since deposition. They are the result of the action of the natural forces upon argillaceous beds which, it may be assumed, were largely structureless, loosely aggregated and possessed plasticity when first deposited. It is the function of the processes of grinding and tempering the clay for manufacture to break down whatever structure may have been induced through the action of these natural agents and to return it to the original plastic state. Some clays are more easily disintegrated than others, and it is the degree to which the hardening process has gone on and the extent to which structure is developed in a clay that determines the sort of preparation required. It is always imperative that the body of clay wares be as nearly structureless as possible, so it is the aim in reducing clay to the moldable condition to eliminate all possible traces of the natural structure of the clay bank.

The structure of burned clay that is of importance depends on the operation of the molding machinery by which undesirable laminations are oftentimes brought about. Auger and laminated structure in bricks made by the stiff mud process are included in this class and will be discussed later under the consideration of the auger machine.

COLOR.

The colors which clays assume are almost infinitely variable. Pure hydrous silicate of alumina is white, but when contaminated with iron may take on a cream, yellowish, red or brown shade. Common clays are colored brown, red, black, blue, gray, buff, and all tints between. The common coloring matters existing in clays are: iron compounds, carbonaceous matter and occasionally manganese oxid. The iron minerals are usually responsible for the reds, buffs and brown colors in clays. Moreover, the blue, black and gray shades are frequently due to iron car-

bonate (FeCO_3) in the fine, disseminated condition. Most of the blue, black and purplish tints, however, may be attributed to the presence of organic matter. Reds are also sometimes due to a finely divided vegetable residue.

Until the cause of the coloration is known, it is impossible to predict what color a clay will burn from its color in the unburned state. The color of the raw clay is especially misleading if it is due to carbonaceous or organic material. The latter is all combustible and when the clay is burned disappears. It will leave the clay with any color which its mineral constituents give it. Carbonaceous matter may, therefore, mask the presence of a percentage of iron which, after the clay is burned, is sufficient to give it a red color; or the raw clay may possess a decided black or purple color which on burning may become white or buff.

The colors of burned clay are much the same as the unburned except the variety is diminished. The shades are also more brilliant and clearer than in the raw clay. Whites, reds, yellows, buffs and pinks are common. In hard burnt, vitrified ware such as paving brick and sewer pipe, brown, green and sometimes black are shown. These result from the formation of the silicate of iron due to the high temperature in burning. The iron is first reduced to the ferrous or protoxid condition in which it is very active at elevated temperatures and combines with silica as the black or green silicate of iron. The reds, buffs and pinks are caused by iron oxid in different proportions and in different states of division and distribution. The same percentage of iron may in one clay give a red color, while in another only a buff or yellow. The yellows of calcareous clays often result from the masking effect of calcium carbonate on the oxid of iron. An excess of alumina in the presence of iron oxid also has a similar effect. But the fine buffs are a distinct type and appear to result from a peculiar distribution of the particles of iron oxid

in the clay, probably in a very finely divided condition and perfectly disseminated throughout the body of the clay, or possibly in chemical combination with the elements of the clay itself. It is such that it is impossible by mechanical mixture to produce the same shade to be had in the natural clay.

FEEL.

The feel test is one of the first to which the prospector resorts in ascertaining the texture and plasticity of a clay. The feel of the powdered, dry clay between the fingers tells something of its texture and grain. Between the teeth, degrees of grittiness may be detected. This is, indeed, quite a reliable way of distinguishing arenaceous and fine-grained clays. Wet with water, clays become soft and if plastic will have a soapy or greasy feel when rubbed with the fingers. Sandy and coarse-textured clays do not exhibit this unctuous or oily nature to the touch and are less cohesive and less capable of being molded. A very unctuous clay is said to be "fat" while a sandy, non-cohesive clay is spoken of as "short" or "lean."

SLAKING.

A substance slakes when by the addition of water it is broken into flakes or small particles and slowly crumbles down. The most common example of slaking is the action of common quick lime when it comes in contact with water. There is a slight swelling of the mass and it is slowly reduced to a pulverulent condition.

This same disintegration takes place in air dried clays when they are immersed in water. The rapidity and completeness of the breaking down vary with different clays. Indurated shales slake slowly, some requiring grinding before the water produces any appreciable effect upon them. Some shales which appear quite hard and stony will slake to a very plastic mass in a few moments. Others, in appearance more porous, crumble with

difficulty. Loess and alluvial clays slake very readily. They reduce practically to a loose aggregate of constituent mineral grains by the action of still water, while shales are left in a more or less lumpy condition, or in scales or flakes. In order to separate the latter into its constituent particles, they must be pulverized and thoroughly agitated in water.

To determine the slaking properties of the different types of clays, samples of the natural clays were broken into pieces, the largest having a diameter of one inch. These were immersed in water and the time noted which elapsed before they were completely slaked. The interval required for its accomplishment ranged from five minutes to several weeks and a few of the most stony shales showed little alteration even then. Those which did not slake were prevailingly poorly plastic and developed very low tensile strength after pulverization and mixing with water. The shale clays which slaked most rapidly and completely were as a rule the finest grained and strongest, although this can only be said of this one class. Of the loess and alluvial clays, the leaner, sandier varieties seemed to slake better than those of finer grain.

The importance of this property is obvious. A clay which takes water eagerly and rapidly crumbles down will work up into the plastic, moldable condition with greater readiness than one that requires pulverizing before water has any appreciable influence upon it. It is important also in the weathering of clays. Where clays or shales are exposed to the atmosphere for considerable periods of time, they gradually break down or weather. The influence of water in the weathering of clays is greater than in the weathering of most rocks. On ordinary hard rocks, water exerts a mechanical disintegrating influence in the process of freezing and thawing. It exerts a chemical influence in the processes of hydration and solution. Clays are alike subject to the effects of these processes but also susceptible

to the slaking power of water. Slaking takes place only when more water is present than the clay can slowly absorb, and further, only when this water is suddenly given the clay when it is perfectly dry. Moist or wet clay, although it will gradually crumble down if surrounded by water, does not "slake" as does the dry clay which also reduces to a powder in a much shorter time. A certain amount of water in a mass of clay may, therefore, tend to preserve its shape, while if an equal amount more be added the clay will disintegrate. It is the sudden access of water to masses of dry clay during rains that produces the most perceptible results. Where clays are hard and difficult to work, they can often be improved by breaking down a supply in advance of use and spreading it out where it will be exposed to rains or where it can be wet down intermittently from the hydrant.

STRENGTH.

The cohesion of clays may be tested from two standpoints, that of tension and of compression or resistance to crushing. Dry clays exhibit in these respects much higher strengths than do dry masses of other substances which have been similarly powdered, wet and molded. Likewise, in the wet condition, clays possess a strength and tenacity to an extent not observed among other minerals. On first consideration, it may be suggested that the tenacity of dry clay may come from some chemical reaction accompanying drying, similar to the setting process in mortars. Since it is known that this tenacity is not destroyed by repulverization, wetting and drying, it is plain that the strength of clays must be due not to a chemical change in drying but entirely to the physical cohesion of the mineral particles of which the clay is composed. It may possibly be due to an interlocking of their grains or to some special shape which gives them large areas of contact with each other. This would also

account for their unusual strength while in the plastic condition.

It is found in general that the fine-grained and plastic clays make the strongest dry product. For this reason the strength of clays is used to express relative plasticity as will be discussed under that heading.

A knowledge of the strength of clays in both the plastic and the dry condition is essential, as it has a practical bearing on all the problems of molding, handling and drying the ware. The tougher a clay is when tempered to the desired emollescence for molding, the more perfect and strong will be the ware, the less danger is there in handling, and from cracking in drying. In the pottery industries, especially, the clay must be of such quality that it will mold perfectly into thin pieces of ware and at the same time be sufficiently firm when dry to stand the weight of perhaps many superincumbent pieces when stacked in the kiln. It is this property of great strength when dry, combined with plasticity, or molding power, which makes clay one of the most useful of materials.

In the table at the end of this chapter are given the results of the tensile strength tests made in the preparation of this report. No systematic crushing tests of raw clays have thus far been carried on. The results of the tests of finished products will be given in the chapter on Tests of Clay Products.

In preparing the raw clays as they came in from the different pits over the state, for making the several physical tests, it was necessary to adopt at the beginning a certain standard method of preparation which would be invariably followed. It is plain that this must be done in order that results could be in any degree satisfactory and comparable. The following is a detailed statement of the scheme followed throughout the process of making the tensile tests and, up to the mixing of the clay with water, exactly as practiced in preparing for all the other tests.

After air drying, the clays were ground to pass a 40-mesh sieve. The coarsest grain passing this sieve measures five-tenths of a millimeter in diameter. The pulverizing was done in a Weatherhead mortar. This is a recent form of mortar and as a hand grinding machine for small batches of any kind of hard material it has given good service. It consists of a rotating, steel-faced pestle within a heavy iron shell. The pestle weighs about sixty pounds and has a diameter of nine inches. It has a corrugated, conical opening in the center into which the material to be ground is introduced. This opening fits down over a corrugated crushing post which projects from the bottom of the metal shell. Rotation of the pestle by means of two handles on opposite sides crushes the clay, which then passes between the pestle and the bottom of the casing and by centrifugal force is carried to the outer rim of the pestle. Here is a row of steel lugs which carries the pulverized material round to the spout where it is discharged. In order to work perfectly in this, as in any other mortar, clays must be thoroughly dry or they will pack and clog.

When a sufficient quantity for the test had been pulverized, it was placed in an air bath in as shallow dishes as convenient and dried at 110° C. for three-quarters of an hour. This precaution was taken to avoid all possible irregularity that might arise from the presence of hygroscopic moisture. Clays, at ordinary temperatures and average humidity, contain 1 to 4 per cent of water which can only be expelled by drying at temperatures above boiling and which will be again absorbed if the clay is let stand in contact with the outside atmosphere. As soon as cool enough to be handled, the clay was weighed out in batches each to make four brickettes. With an average percentage of water, it was found that the four required sixteen ounces of clay. The required amount of water was weighed in a small porcelain mortar and the dry clay added directly to this.

In beginning the work, it was thought desirable to make a series of mixtures with each clay with varying percentages of water. This was carried out by making sets of four brickettes each with contents of water differing by 2.5 per cent from least to greatest workable plasticity. For instance, it was sometimes found that a clay could be made up with 25, 27.5 and 30 per cent of water, or 20, 22.5, 25, 27.5 and so on. In all cases, of course, with the lowest percentage of water the clay was too stiff to work well, while with the largest amount it was often quite sticky. The average amount of water for the best plasticity was 25 to 27.5 per cent based on the weight of the dry clay as 100. So in weighing out clay and water it was usually found expedient to first strike a medium, say 25 per cent, and then vary each way from this.

The clay and water were then thoroughly worked together with the pestle in the mortar and finally kneaded with the hands until of an equal consistency throughout. The clays were molded in standard sized, brass cement molds. Some experimenting was necessary to ascertain the best method of filling the molds. Wheeler* advocates filling by pressing in with the fingers separate small pieces of the wet clay. He advised this method to avoid including air bubbles and to prevent laminations in the brickette. It was the experience of the writer that it was impossible to fill the molds in this way without, in the majority of cases, entrapping small blebs of air or leaving flaws in the brickette by the incomplete amalgamation of the small, separate masses of clay. By pressing alone, it is difficult to cause the pieces to unite so the division line can not be detected. Sample brickettes broken in search of these defects would quite often part along the contact between two bodies of clay, each of which still showed distinctly the imprints of the fingers. Professor Edw. Orton, Jr.,† has found the following method to give

* Clay Deposits of Missouri Missouri Geol. Survey, Vol. XI, p. III.

† Transactions American Ceramic Society, Vol. II, p. 110.

uniform results and his method in its essentials was adopted in the present experiments.

“After the clay had been wedged and had been brought into a condition which seemed to possess the greatest plasticity of which the mixture was capable, it was worked out into a cylindrical roll about three inches in diameter and about eight inches in length; this was now cut up into seven sections, using for this purpose a bit of fine wire or a stout linen thread. The freshly cut surface was examined for interior defects, flaws, or laminations, and if any were found the mass was wedged further and tested again in the same manner, until it was found to be free from any evidence of defective structure.”

“When this condition was attained, one of the circular pats, which was about three inches in diameter, and about one and one-eighth inches in thickness, was put into an opened cement mold. The mold was adjusted so that a portion of the clay stuck out from it equally on either side. The mold was now clamped together, the narrowest portion indenting itself slightly into the clay; the mold was then filled by carefully pounding the clay into the mold with light blows delivered by the bare hand. One side was pounded for a short time, and then the other, so that the excess clay was gradually worked into shape and filled both ends of the mold. The surface was then stroked off level with the top of the mold, and the brickette was removed from it by the use of a plaster of Paris block which fitted the interior of the mold neatly.”

The clay was kneaded and wedged until plastic and until a cross section of it showed the absence of air spaces or laminations. Each of the molds was then filled by taking a piece of the kneaded clay more than large enough to fill a mold and forming it so its smallest thickness was about the minimum width of the mold, one inch. This was placed against one side and the other half of the mold was clamped against it, somewhat indenting

the clay at the center. The wider portions of the mold were filled by carefully pressing the clay into each side with the fingers. By means of a wooden block which was made to fit the mold exactly, the clay was firmly settled into the mold by a couple of blows with the hand. The surface of the brickette was then leveled off with a small pointing trowel. This method of filling the molds makes a much more homogeneous brickette and the liability of including air or producing laminations in the constricted portion of the brickette where, of all parts, it is most desirable to have the clay structureless, is reduced to a minimum. Each brickette was stamped with its serial number and the percentage of water.

By means of a sponge, the molds were coated with a thin film of oil and were filled on a heavy glass plate also covered with oil. The primary function of the oil was to prevent sticking and to facilitate removal from the mold. The oil served a double purpose, however, by also preventing too rapid drying of the brickettes. The brickettes were removed from the mold as soon as stiff enough to retain their shape, which they would not do at once in instances where high percentages of water were used. They were taken out when sufficiently stiff and placed on a plaster of Paris bench to dry. Drying required from one to four or five days. If allowed to remain long placed flat down on the bench while drying, more or less of distortion resulted, especially with those clays having a high shrinkage. This was obviated entirely by turning the brickettes up on edge after a few hours, so that drying could take place equally from all directions.

Two sets of brickettes of each clay were made, one the exact duplicate of the other. One set was tested dry and the other burned and tested.

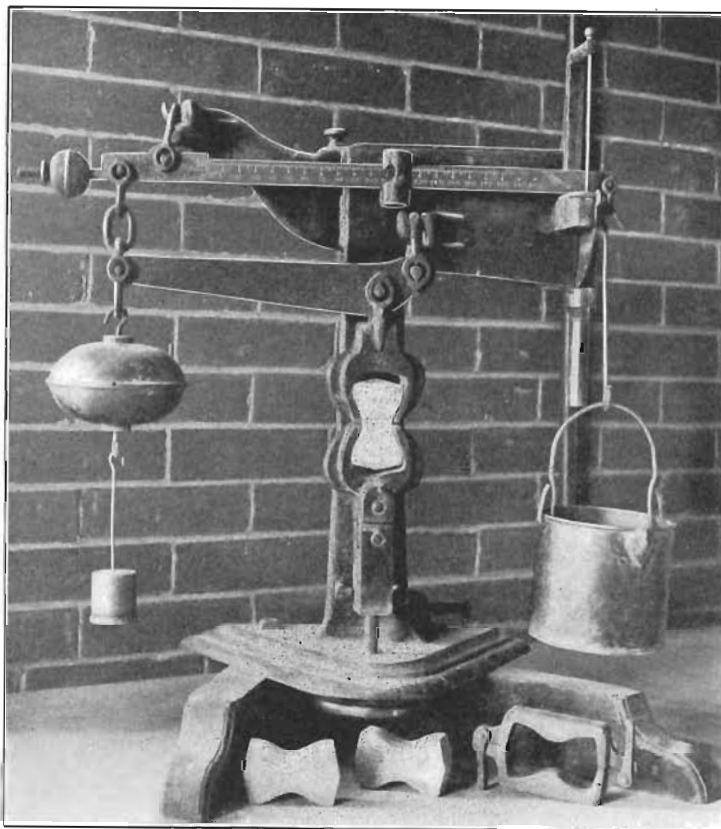

FIG. 1. Fairbanks machine used in measuring the tensile strength of clays.

The testing was done with a Fairbanks cement machine. Previous to breaking, the minimum cross section of each brickette was measured. This was necessary because of the shrinkage of the clay in drying. The brickettes were then placed in the air bath and heated at 110° C., for one hour, to remove hygroscopic moisture. The presence of a small percentage of moisture in the clay will appreciably modify the results.

In the manipulation of the testing machine, considerable difficulty was encountered in securing perfect breaks in the smallest cross section of the brickette. Owing to the shrinkage of the clay in drying, the brickettes did not fit perfectly into the grips of the machine. Care was taken to get as straight a pull as possible in the axis of the brickette, but even after all precaution was taken the clay would more often part between the ends of the grips than in the middle. Comparison showed that brickettes breaking in this way had as high tensile strength as those which broke at the smallest diameter. No discrimination was therefore made in averaging up the results. Lining the grips with blotter paper was tried, but no advantage was gained by this expedient. The same difficulty was met to some extent in breaking the burned brickettes, but as in the dry clay tests no discrimination was made in results on that account.

The second set of brickettes was burned in a Hoskins Muffle furnace (See Fusibility) to 800°.C., and held at that heat from one to one and one-half hours. Being a muffle, there is, because of its construction, little opportunity for draft, but throughout each burn effort was made to produce a slight flow of air through the clay. At 800 degrees the processes of dehydration and oxidation should be complete and the object of producing a slight air circulation through the muffle was to favor these chemical reactions.

The design in burning a series of brickettes was to ascertain the relation between the strength of clays in the raw state and in the burned condition. In other words, to determine whether the strongest clays unburned would maintain their prestige after burning. It was first thought to burn to vitrification. This, however, was soon discovered to be impossible. Some of the clays would not vitrify. Among vitrifying clays, the temperatures required are so different, and so dissimilar do they act, that it was believed no results of any value would be obtained.

By burning all of the clays to a good red heat, subjecting them to conditions exactly alike, we know that only certain reactions have taken place, hydration and oxidation, and these have occurred in each and every clay whether refractory or fusible. Results obtained under these conditions are comparable and may prove of interest in connection with the data obtained from the dry clay tests.

The burnt brickettes were accurately measured and broken in the Fairbanks machine, and the strengths per square inch calculated as given in the table.

STRENGTH.

| CLAY. | PRODUCTS MANUFACTURED. | Per cent of water. | TENSILE STRENGTH IN POUNDS PER SQUARE INCH. | | | | | | | | | | | | |
|---|--------------------------|--------------------|---|------|------|-------|-----|-------|------------|--------------|-------|-------|--|--|--|
| | | | DRY CLAY. | | | | | | Aver. age. | BURNED CLAY. | | | | | |
| | | | | | | | | | | | | | | | |
| Flint Brick Co., Des Moines, Iowa, top stratum. | Paving and common brick. | 22.5 | 201 | *180 | 221 | 194 | 205 | 660 | 638 | *417 | 635 | 644 | | | |
| | | 25.0 | 193 | 236 | 239 | 277 | 236 | 515 | 494 | 430 | 534 | 494 | | | |
| | | 27.5 | *178 | 203 | 212 | 218 | 213 | 409 | 447 | 353 | 608 | 454 | | | |
| | | 30.0 | 201 | 196 | 167 | 192 | 189 | 476 | 539 | *378 | 598 | 534 | | | |
| Flint Brick Co., Des Moines, Iowa, middle stratum. | Paving and common brick. | 25.0 | 142 | 164 | 176 | 152 | 159 | 636 | 645 | 848 | 755 | 721 | | | |
| | | 27.5 | 153 | 166 | 161 | *122 | 161 | 637 | 699 | 854 | 902 | 774 | | | |
| | | 30.0 | 150 | 164 | 188 | *120 | 167 | 696 | 788 | 694 | 544 | 653 | | | |
| | | 32.5 | 115 | 116 | 125 | 123 | 120 | 837 | 970 | 714 | 644 | 791 | | | |
| Flint Brick Co., Des Moines, Iowa, bottom stratum. | Paving and common brick. | 25.0 | 87 | 92 | 70 | 81 | 83 | 249 | 415 | 402 | 329 | 349 | | | |
| | | 27.5 | 73 | 71 | 90 | 85 | 80 | 331 | 292 | 340 | 361 | 331 | | | |
| | | 30.0 | 64 | 79 | 65 | 70 | 70 | 152 | 253 | 182 | 124 | 178 | | | |
| Flint Brick Co., Des Moines, Iowa, green brick. | Paving brick. | 25.0 | 94 | 98 | 91 | 129 | 103 | 622 | 937 | 768 | 902 | 805 | | | |
| | | 27.5 | 128 | 133 | 150 | *99 | 137 | 359 | 542 | | 466 | 456 | | | |
| | | 30.0 | 142 | 115 | 111 | 125 | 128 | 607 | 514 | *300 | 516 | 586 | | | |
| Iowa Brick Co., Des Moines, Iowa, top stratum. | Paving and common brick. | 17.5 | 142 | 157 | 135 | 139 | 143 | 174 | 203 | 209 | 172 | 190 | | | |
| | | 20.0 | 130 | 156 | 142 | 131 | 145 | 192 | 191 | 222 | 225 | 208 | | | |
| | | 22.5 | 130 | 130 | 139 | 119 | 130 | 101 | 97 | 200 | | 133 | | | |
| | | 25.0 | 174 | 143 | 137 | 188 | 161 | 217 | 248 | 183 | 192 | 210 | | | |
| Iowa Brick Co., Des Moines, Iowa, second from top. | Paving and common brick. | 27.5 | 103 | 141 | 113 | 167 | 132 | 147 | 246 | 267 | 204 | 216 | | | |
| | | 25.0 | 89 | 92 | 84 | 83 | 87 | 212 | 237 | 243 | 238 | 233 | | | |
| | | 27.5 | 56 | 68 | 73 | 80 | 69 | 175 | 226 | 215 | 170 | 197 | | | |
| | | 30.0 | 70 | 76 | 71 | 59 | 69 | 101 | 161 | 168 | 249 | 170 | | | |
| Iowa Brick Co., Des Moines, Iowa, third from top. | Paving and common brick. | 32.5 | 73 | 65 | 62 | 78 | 70 | | | | | | | | |
| | | 27.5 | 103 | 114 | 95 | 105 | 104 | 729 | 797 | *470 | 532 | 606 | | | |
| | | 30.0 | 99 | 91 | 111 | 101 | 101 | 593 | 616 | 654 | 588 | 613 | | | |
| | | 32.5 | 89 | 102 | 93 | *78 | 95 | 407 | 538 | 532 | 596 | 518 | | | |
| Iowa Brick Co., Des Moines, Iowa, fourth from top. | Paving and common brick. | 35.0 | 68 | 72 | 71 | 83 | 74 | *855 | 542 | 511 | 627 | 506 | | | |
| | | 25.0 | *110 | 164 | 144 | 151 | 153 | 803 | 714 | 564 | 615 | 674 | | | |
| | | 27.5 | 179 | 179 | 153 | | 170 | 794 | 607 | 669 | 662 | 683 | | | |
| | | 30.0 | 168 | 198 | 152 | *143 | 173 | 678 | 651 | *490 | 652 | 690 | | | |
| Iowa Brick Co., Des Moines, Iowa, fifth from top. | Paving and common brick. | 32.5 | *126 | 161 | 170 | 177 | 169 | 549 | 595 | 465 | 636 | 539 | | | |
| | | 25.0 | 72 | 76 | 62 | 72 | 71 | 106 | 93 | 136 | 90 | 106 | | | |
| | | 27.5 | 61 | 66 | 60 | 72 | 65 | 228 | 141 | 220 | 203 | 196 | | | |
| | | 30.0 | 64 | 51 | 59 | 60 | 57 | *156 | 224 | 228 | 269 | 240 | | | |
| Iowa Brick Co., Des Moines, Iowa, bottom stratum. | Paving and common brick. | 27.5 | 120 | 112 | 118 | 121 | 118 | 228 | 365 | 336 | 567 | 974 | | | |
| | | 30.0 | 86 | 88 | 100 | 82 | 89 | 233 | 315 | 443 | 437 | 357 | | | |
| | | 32.5 | 96 | 62 | 63 | *57 | 70 | 321 | 232 | 291 | 457 | 320 | | | |
| | | 35.0 | 64 | 66 | 64 | *55 | 65 | 215 | 385 | 395 | 312 | 327 | | | |
| Capital City Brick and Pipe Co., Des Moines, Iowa, top stratum. | Paving and common brick. | 37.5 | 65 | 55 | 51 | 53 | 58 | 153 | 161 | 271 | 151 | 184 | | | |
| | | 30.0 | 191 | 169 | 209 | 204 | 193 | *346 | 670 | 638 | 831 | 713 | | | |
| | | 32.5 | 148 | 179 | 198 | 161 | 172 | 595 | 600 | 669 | 743 | 677 | | | |
| | | 35.0 | 145 | 164 | 137 | 136 | 146 | 1079 | 1075 | 798 | 1052 | 1001 | | | |
| Capital City Brick and Pipe Co., Des Moines, Iowa, second from top. | Paving and common brick. | 37.5 | 140 | 121 | 118 | 192 | 143 | 759 | *423 | 862 | 871 | 811 | | | |
| | | 40.0 | 106 | 142 | 139 | 155 | 136 | 644 | 817 | 999 | 1042 | 576 | | | |
| | | 22.5 | 92 | 114 | 107 | 122 | 109 | 606 | 461 | 551 | 550 | 542 | | | |
| | | 25.0 | *128 | 116 | 110 | 101 | 114 | 436 | 560 | 712 | 625 | 586 | | | |
| Capital City Brick and Pipe Co., Des Moines, Iowa, third from top. | Paving and common brick. | 27.5 | *86 | 106 | 91 | 110 | 102 | 394 | 434 | 537 | 600 | 491 | | | |
| | | 22.5 | 132 | 158 | 204 | 199 | 178 | 397 | 460 | 401 | 394 | 426 | | | |
| | | 25.0 | 195 | 236 | 184 | 202 | 204 | 474 | 669 | 582 | 582 | 577 | | | |
| | | 27.5 | 167 | 224 | *104 | 197 | 196 | 390 | 433 | 473 | 533 | 457 | | | |
| Capital City Brick and Pipe Co., Des Moines, Iowa, fourth from top. | Paving and common brick. | 30.0 | 205 | 198 | 212 | *137 | 205 | | | | | | | | |
| | | 22.5 | 89 | 106 | 86 | 91 | 93 | 207 | 209 | 154 | 247 | 204 | | | |
| | | 25.0 | 81 | 74 | 69 | 98 | 81 | 276 | 175 | 259 | 176 | 222 | | | |
| | | 27.5 | 78 | 67 | 71 | 88 | 76 | 384 | 400 | 173 | 326 | 321 | | | |
| Capital City Brick and Pipe Co., Des Moines, Iowa, bottom. | Paving and common brick. | 30.0 | 82 | 90 | 64 | 60 | 74 | 199 | 253 | 303 | 299 | 204 | | | |
| | | 22.5 | 55 | 47 | 53 | 62 | 52 | 173 | 153 | *98 | 151 | 154 | | | |
| | | 25.0 | 43 | 44 | 50 | 46 | 46 | 180 | 194 | 149 | 121 | 161 | | | |
| | | 22.5 | 153 | 184 | 142 | 151 | 148 | 526 | 351 | 419 | 403 | 425 | | | |
| Capital City Brick and Pipe Co., Des Moines, Iowa, green brick. | Paving brick. | 25.0 | 168 | 188 | 172 | 157 | 171 | 535 | 676 | 509 | 556 | 582 | | | |
| | | 27.5 | 152 | 171 | 170 | 124 | 154 | 425 | 702 | 334 | 500 | 503 | | | |

TECHNOLOGY OF CLAYS.

| CLAY. | PRODUCTS MANUFACTURED. | Per cent of water. | TENSILE STRENGTH IN POUNDS PER SQUARE INCH. | | | | | | | | | | |
|--|------------------------------|--------------------|---|-----|-------|------|-----|-------------|--------------|-------|-------|-----|-------------|
| | | | DRY CLAY. | | | | | Aver. area. | BURNED CLAY. | | | | |
| | | | | | | | | | | | | | Aver. area. |
| Granite Brick Co., Burlington, Iowa, top stratium. | Paving and building brick. | 22.5 | 45 | 42 | 43 | 58 | 47 | 111 | * 17 | 80 | 52 | 81 | |
| | | 25.0 | 69 | 56 | 56 | 69 | 63 | 78 | 82 | 105 | | 89 | |
| | | 27.5 | 63 | 49 | 56 | 68 | 59 | 68 | 74 | 83 | 82 | 77 | |
| Granite Brick Co., Burlington, Iowa, lower stratium. | Paving and building brick. | 22.5 | 91 | 84 | 83 | 85 | 86 | 398 | 314 | 433 | 457 | 399 | |
| | | 25.0 | 75 | 64 | 80 | 71 | 73 | * 170 | 394 | 343 | 251 | 809 | |
| | | 27.5 | 76 | 63 | 75 | 89 | 76 | 214 | 218 | 358 | 426 | 304 | |
| Clermont Brick and Tile Co., Clermont, Iowa. | Common brick. | 20.0 | 81 | 84 | 81 | 93 | 85 | 367 | 656 | 558 | 482 | 516 | |
| | | 22.5 | 81 | 77 | 106 | 88 | 88 | * 189 | * 250 | 765 | 585 | 675 | |
| | | | | | | | | black cones | | | | | |
| American Brick and Tile Co., Mason City, Iowa, Devonian shale. | Common brick and drain tile. | 30.0 | 190 | 235 | 198 | 218 | 210 | 524 | 861 | 612 | 748 | 686 | |
| | | 32.5 | 138 | 163 | 165 | 146 | 153 | * 813 | 705 | 548 | | 626 | |
| | | 35.0 | 153 | 164 | 169 | 174 | 166 | 605 | 447 | 454 | 733 | 567 | |
| Jester Clay Bank, near Danville, Iowa. | Unused. | 20.0 | 117 | 91 | 109 | 122 | 110 | 140 | 161 | 218 | 133 | 163 | |
| | | 22.5 | 116 | 122 | 117 | 136 | 123 | 123 | 126 | 137 | 116 | 126 | |
| | | | | | | | | | | | | | |
| Harris Brick Yard, Rockford, Iowa, Devonian shale. | Common brick. | 22.5 | 176 | 154 | 142 | 176 | 162 | | 177 | 186 | 506 | 807 | |
| | | 25.0 | 163 | 161 | 171 | 189 | 176 | 357 | 177 | 186 | 506 | 807 | |
| | | 27.5 | 135 | 138 | 137 | 142 | 133 | 151 | 283 | 143 | 245 | 213 | |
| Dale Brick Co., Des Moines, Iowa, top loess. | Common and pressed brick. | 22.5 | 270 | 219 | 240 | 249 | 245 | 214 | 212 | 237 | 246 | 227 | |
| | | 25.0 | 231 | 230 | 191 | 261 | 228 | 237 | 112 | 167 | 182 | 175 | |
| | | | | | | | | | | | | | |
| Dale Brick Co., Des Moines, Iowa, bottom shale. | Common and pressed brick. | 22.5 | 82 | 74 | 73 | 74 | 76 | 75 | 77 | 69 | | 74 | |
| | | 25.0 | 99 | 90 | 81 | 102 | 93 | 185 | 99 | 148 | 84 | 129 | |
| | | 27.5 | 66 | 79 | 78 | 74 | 73 | 84 | 94 | 89 | 102 | 92 | |
| Corey Pressed Brick Co., Lehigh, Iowa, red burning clay. | Dry-press brick. | 25.0 | 113 | 90 | 97 | 94 | 99 | 698 | 532 | 625 | 861 | 679 | |
| | | 27.5 | 143 | 118 | 124 | 116 | 125 | 792 | 629 | 669 | 477 | 642 | |
| | | 30.0 | 140 | 147 | 124 | 144 | 139 | 712 | 549 | 573 | 653 | 609 | |
| | | 32.5 | 148 | 131 | 112 | 143 | 134 | 695 | 392 | 500 | 533 | 504 | |
| Corey Pressed Brick Co., Lehigh, Iowa, buff burning clay. | Dry-press brick. | 25.0 | 73 | 88 | 110 | 117 | 97 | 984 | 1100 | 816 | 875 | 944 | |
| | | 27.5 | 161 | 137 | 166 | 114 | 145 | 770 | 544 | 663 | 789 | 692 | |
| | | 30.0 | 142 | 117 | 125 | 130 | 129 | 663 | 725 | 721 | 618 | 633 | |
| | | 32.5 | 140 | 118 | 154 | 149 | 140 | 682 | 840 | 814 | 972 | 827 | |
| Near Colesburg, Iowa, potting clay. | | 27.5 | 94 | 82 | 91 | 75 | 86 | 910 | 580 | 693 | 1036 | 880 | |
| | | 30.0 | 96 | 90 | 103 | * 68 | 96 | 571 | 898 | 862 | * 474 | 775 | |
| | | 32.5 | 91 | 105 | * 55 | 88 | 95 | 1111 | 982 | 826 | 897 | 954 | |
| Storm Lake Brick and Tile Co., Storm Lake, Iowa, Wisconsin drift | Common brick and drain tile. | 25.0 | 200 | 249 | 237 | 265 | 238 | 604 | 669 | 634 | 630 | 634 | |
| | | 27.5 | 240 | 297 | 285 | 307 | 282 | 813 | 676 | 549 | 675 | 628 | |
| | | 30.0 | 310 | 296 | 313 | 349 | 317 | 592 | 403 | | | 407 | |
| Besley Brick Yard, Council Bluffs, Iowa, top loess. | Common brick. | 22.5 | 163 | 128 | 140 | 136 | 142 | 112 | 132 | 133 | 107 | 122 | |
| | | 25.0 | 123 | 135 | 122 | 163 | 137 | 93 | 128 | 119 | | 110 | |
| | | 27.5 | 112 | 124 | 129 | 149 | 129 | 102 | 97 | 130 | 97 | 107 | |
| Besley Brick Yard, Council Bluffs, Iowa, middle loess. | | 22.5 | 176 | 207 | * 113 | 182 | 183 | 203 | 182 | 135 | 153 | 168 | |
| | | 25.0 | 195 | 167 | 150 | 186 | 175 | 141 | 138 | 97 | 148 | 131 | |
| | | 27.5 | 211 | 152 | 172 | 198 | 183 | 120 | 115 | 103 | 114 | 113 | |
| Besley Brick Yard, Council Bluffs, Iowa, bottom loess. | | 22.5 | 187 | 211 | 245 | 273 | 229 | 241 | 232 | 205 | 211 | 235 | |
| | | 25.0 | 244 | 263 | 279 | 264 | 263 | 260 | 288 | 262 | 255 | 266 | |
| | | 27.5 | 214 | 310 | 216 | 195 | 234 | 213 | 246 | 327 | 291 | 269 | |
| Gethmann Bros., Gladbrook, Iowa, inland loess. | Dry-press brick. | 25.0 | 242 | 208 | 233 | 275 | 240 | 214 | 280 | 628 | 600 | 431 | |
| | | 27.5 | 262 | 528 | 293 | 270 | 283 | 183 | 526 | 546 | 467 | 431 | |
| | | 30.0 | 299 | 295 | 328 | 312 | 309 | 401 | 176 | 202 | 159 | 235 | |

* Not included in averages. In these instances the brickettes exhibited defects which were responsible for the abnormal figures.

In the operation of the Hoskins kiln, in which the clays were burned, it was difficult to bring about the same degree of oxidation in all the samples. The open-textured, porous clays oxidized readily, but under the same conditions clays that were dense and fine-grained were only partially oxidized. On these facts may be explained some of the irregular results which appear in the table. The range of variation in the strength of brickettes of the same clay and same percentage of water after burning is much greater than with the dry clays. In the latter, it is unusual to find a variation of 30 per cent above or below the average, while in the results of the burnt clay tests departures as high as 50 per cent occur. The chances of error due to such variation would be much lessened by using a larger number of brickettes from which to obtain the average result. At least double the number used in these experiments is recommended.

The work that has been carried on along this line demonstrates forcibly the necessity of exercising extreme care in all parts of the experiments. The clays should be molded, measured and broken by the same person and the complete process standardized in every particular in order to obtain the most uniform and useful results.

BONDING POWER.

The bonding power of clays is defined as the ability to stand the addition of non-plastic matter. The clays standing the addition of the largest amount of sand or other inert substance and whose strength is least impaired by such addition is said to possess the greatest bonding power. This property would, therefore, be tested by determining the relative strengths of different clays when mixed with varying proportions of sand. Bonding power is thought to bear a definite relation to the plasticity of clay; those clays which are highly plastic usually allowing the greatest dilution with the least diminution in strength.

A knowledge of the bonding power of clays is of practical importance as a guide to correct mixtures wherever, in the process of clay manufacture, it is necessary to use two or more clays together or to mix inert material with a plastic clay. Sand is often used to decrease the shrinkage and to render the clay body more open in texture. In the manufacture of many of the higher grades of pottery wares and refractory materials, non-plastic kaolins and flint clays are mixed with plastic clays alike to decrease shrinkage and to influence porosity; also to give firm body, refractory or other physical properties, to the ware in question. Since the plastic clay acts as the bonding agent, in all such instances, it is essential to know how much of the non-plastic ingredients may be used and still give the required strength of product.

There are several classes of non-plastic materials used in clays. They may be separated into two divisions, viz., mineral and combustible compounds. In the former are included quartz, chamotte or grog, and lime. Quartz is added as sand, as a sandy clay, in the finely divided state in which it exists in the infusorial and diatomaceous earths, or as ground flint or sandstone. Chamotte or grog has reference to the use of pulverized burned clay ware, fire brick or other refractory wares, as an admixture in plastic clays. Lime is used in this connection in the form of powdered limestone, marl or slaked lime. These additions are for the purpose of decreasing shrinkage and produce only physical differences in the ware made. In the case of lime it is necessary to add a large proportion as it becomes an active flux at high temperatures.

It has long been held to be true that the finer the grain of inert, non-plastic matter in clays the less plasticity is interfered with and, similarly, the less will the strength of the clay be affected. While generally accepted, no records of experiments are found along this line prior to 1900. In this year Professor

Edw. Orton, Jr.,* published the results of a protracted series of experiments in the course of which he obtained information confirmatory of the generally accepted conditions stated above. From his results he established the following law: "That the non-plastic ingredients of a clay influence its tensile strength inversely as the diameter of their grains, and fine-grained clays will, other things being equal, possess the greatest tensile strength."

Under combustible compounds may be listed, coal, sawdust, straw, peat and other organic materials. It is evident that these substances are detrimental to plasticity and also that they will serve to decrease shrinkage in a plastic clay. When the temperature in burning reaches red heat and above, such matter burns out and thus increases the porosity of the finished ware if it is not burned to vitrification. The latter influence along with its effect as a fuel are the chief functions which combustible materials of any sort serve in a clay. The value of fuel thus incorporated in the body of the clay is high, as in oxidation the heat is generated in immediate contact with the clay that is to be affected by the heat. This fuel begins to burn at red heat and is all available as soon as combustion commences. Its consumption cannot be accurately controlled. Red heat is the stage of the burning process in which combined water is expelled and during which the temperature must be raised very slowly. With any considerable amount of combustible matter in the clay, the danger of over heating by the too rapid rise of the temperature during the water smoking period is always imminent.

PLASTICITY.

Were it not for the property which clays possess of becoming plastic when moistened with water, their economic importance would be almost entirely lost. Clay in the plastic state can be

*Trans. Am. Ceramic Soc., Vol. II, p. 100 and Vol. III, p. 198.

shaped and molded by pressure into any form without rupture and this form is retained not only while moist but when dried out. Plasticity is thus the characteristic of clays, when wet, which allows of their being molded into the innumerable shapes and sizes of modern clay wares. These molded forms are maintained when the clay is dry and are further fixed and rendered less destructible by burning; but we cannot rightfully attribute these last facts to the property of plasticity which has to do alone with the moist clay. Water, therefore, being essential in order to develop plasticity, it cannot truly be said to be a property of the clay itself.

The cause of this valuable property is not fully known. Clays are essentially the hydrous silicate of alumina and viewed from the standpoint of chemical composition it has been suggested that the water held in combination is the cause of plasticity. When this water is driven off at red heat in burning, plasticity is lost and cannot be restored. There are, however, numerous hydrous minerals, several of which are very closely allied in composition to clay, which it is impossible to make plastic under any conditions. If the presence of water were the cause, other hydrous alumina silicates should exhibit this same property. This is the principal fact which makes the "water theory" appear improbable. In studying the structure of clays with the microscope, it has been noticed there are sometimes present hooked or vermicular aggregates of crystal grains which by interlocking and clinging to each other because of their shape, have been thought to give the clay plasticity. These crystals are not usually present in such abundance as would be necessary if we were to account for plasticity by their presence. It has often been found that the clays containing a large number of these peculiar aggregates of grains are less plastic than others in which they are conspicuously absent. This theory is manifestly untenable. Many instances of unusual plasticity in very

impure clays have been noted. It is thought that such impurities as iron and lime compounds sometimes act as bonding agents to hold together the small particles of clay substance which are not of themselves plastic, or, in the colloid state, they may act as oily lubricants. While it may be true that they frequently serve in the way of a cement, they do not allow of any mobility of the clay grains without destroying their binding property. Furthermore, although pure clays, which consist alone of kaolinitic grains, are commonly non-plastic, they frequently possess plasticity or may be made to exhibit this property by pulverization and weathering and without any alteration of their composition. Thus many pure fire clays and ball clays are very plastic. The effect of mixing different sized sands with plastic clays has been shown to be detrimental to plasticity whether the latter is measured by the tensile strength of the dry clay or by other means commonly employed for this purpose. Sandy clays are prevalently less plastic than similar clays which lack the sand. In some instances it may be shown that impurities such as compounds of iron and lime, exert a cementing influence through chemical changes and thus affect the plasticity, if we measure this last quality by the *strength* of the clay, but we cannot hold the impurities present responsible for the working properties of the clay which are usually the best gauge of its plasticity. Unusually plastic clays which are also very impure may better be considered the exception than the rule.

Bearing on this topic from a chemical standpoint a recent writer* attributes plasticity partially to the influence of colloidal substances when the clay is mixed with water. Among the ingredients in clays which might act in this capacity are mentioned hydrated silicic acid, iron and other metallic oxids, aluminum hydroxid and forms of organic matter. These all possess partial and indefinite solubility in water, may be molded, and shrink on drying, and are considered by the above writer to

* Paul Rohland. Zeitschrift für Anorganische Chemie, Band XXXI, Heft 1, p. 158.

exercise always a greater or less influence on plasticity. It is further stated that by the properties of these substances may be explained peculiarities of plastic clays which are not adequately explained by any theory that refers all to the mechanical structure. The idea is an ingenious one and is thought should be considered of importance in clays where any considerable amount of colloids exists; but throughout the large range of common clays, chemical tests will show the very small and inconsiderable proportion of the ingredients which are capable of assuming the colloid state by the action of water alone.

Among the investigators who have studied the subject, there are some who attribute plasticity to the fineness of the grain of the clay. That is, the finer the particles composing the clay, the more plastic it is. As a general rule, this is found to be true. The more plastic clays are usually the finest grained. If, however, fineness alone is the cause, any mineral substance should become plastic if finely ground. Professor Whitney* in his mechanical analysis of soils designates as clay that portion composed of grains below .005 mm. in diameter. In the study of plastic clays it is found they are composed of particles, some of which are larger than this but the great proportion of which range from .005 mm. to such impalpable fineness that the strongest power of the microscope fails to show their size. Professor Whitney's classification is made, however, with reference to no other properties than size of grain and must be, therefore, largely conventional. Nothing is implied with regard to plasticity or other characteristics which must be considered from the standpoint of a user of clay. Mr. Wheeler† conducted experiments with quartz and limestone ground to different degrees of fineness. He ascertained that while the samples ground to pass a 200-mesh sieve were appreciably plastic and could be molded, when dry they were very weak, "dusting" and falling to pieces

* Mechanical Analysis of Soils. Bulletin Department of Agriculture.
† Missouri Geological Survey, Vol. XI, p. 162.

in spite of careful handling, The quartz had the more feeble strength of the two. The somewhat greater strength of the powdered limestone may be partially accounted for by the small proportion of clayey matter which is invariably present in all but the purest limestones; also the more earthy nature of the limestone which would give a powder more of the character of a dust or, mud, when wet, than the glassy quartz whose grains are angular and sharp in outline. Professor Orton* also reports experiments made by grinding glass so exceedingly fine that the particles would float in water for an indefinite period. When collected, this ground glass developed no plasticity with water nor possessed much greater strength than such a paste made from chalk or flour. The fact that the most plastic clays are predominantly the finest grained, suggests that something other than mere size of constituent particles is necessary to fully account for plasticity. It has been shown that hard materials like glass and sand generate some plasticity when powdered, the more the finer, but can never be made eminently plastic by fine grinding. Clays which possess a fair degree of plasticity may be made more plastic by pulverization.

It is thus plain that fineness along with some certain shape or character of grain are both essential to plasticity. If this be true, any powdered mineral made up of grains having the correct shape should become plastic when wet with water. It has been the effort of investigators to determine just what certain shape of grains is conducive to plasticity. Along this line the researches of Johnson and Blake† are classic. They found that most plastic clays examined by them were composed largely of small transparent plates, many of which were grouped together in bundles. On page 356 of the article cited above: "We have examined microscopically twenty specimens of kaolins, pipe and

* Brick, Vol. XIV, No. 4, p. 216.

† American Journal of Science, (2) p. 351, 1876.

fire-clay. Most of these are of unknown origin. In them all is found a greater or less proportion of transparent plates, and in the most of them these plates are abundant, evidently constituting the bulk of the substance." * * * "The plasticity of a clay is a physical character, and appears to have close connection with the fineness of the particles. The kaolinite of Summit Hill, consisting chiefly of crystal-plates averaging .003 of an inch in diameter, is destitute of this quality. The nearly pure kaolinite from Richmond, Va., occurring mostly in bundles of much smaller dimensions, the largest being but .001 of an inch in diameter, is scarcely plastic. * * * The more finely divided fire-clay from Long Island, is more "fat" while the Bodenmais porcelain earth and other clays, in which the bundles are absent and the plates are extremely small, are highly plastic. So, too, the Summit Hill crystals, when triturated in an agate mortar, yield a powder which, when breathed upon, acquires the argillaceous odor, under the microscope perfectly resembles the kaolins, and in the wet state is highly plastic and sticky."

The plate structure of plastic clays was thus early recognized and plasticity attributed to it by these investigators. It was further seen that while the minute plates were the real cause, the finer they existed or were broken up by powdering, the greater the plasticity of the clay. Other investigators have corroborated these observations.

In 1878 Biedermann and Hedzfeld* recognized the plate structure of plastic clays. Biedermann regarded the plasticity of clays as due to the strength of cohesion and adhesion and brought it under Newton's law for the attraction of bodies. While it is probable that Newton's law unmodified would scarcely be applicable in this case, the fact that these early scientists recognized not only the characteristic structure, but likewise the bearing of this structure on the working properties of clays, is of especial interest, since it is the basis on which many of the peculiarities of clay are explained.

* Dr. Carl Bischof, Die Feuerfesten Thone. p. 23.

Haworth* in his examination of Missouri clays found the most plastic clays to be composed of minute scales and in general the abundance of these scales was in proportion to the plasticity of the clay. In fresh, unweathered flint clay the plate-like particles were absent and plasticity was found to be very feeble. It was noted also that the more finely divided the plates were the greater the plasticity.

In Wheeler's report on the Clays of Missouri‡ are recorded experiments with other minerals which possess a lamellar or plate structure. Calcite and gypsum when finely ground were found to become quite plastic with water and to have tensile strengths as high as 100 and 350 pounds per square inch respectively when dry. It would seem that calcite should afford an excellent example for a test of this sort. It is decidedly lamellar because of its perfect cleavage, always breaking into small plates or rhombs no matter how finely pulverized. Its strength would be entirely due to the physical attraction of the particles for the surrounding ones through the film of water enveloping each grain. Gypsum, on the other hand, is somewhat soluble in water and the strength attained may be partly due to solution and recrystallization as the water evaporated. Results obtained with powdered slate lead in the same general direction. Because of its tendency to cleave, slate finely ground would consist of a mass of very small lamellae or scales. When ground exceedingly fine, slate could be molded and on drying it possessed considerable strength. Other lamellar minerals were tried and all exhibited a greater or less degree of plasticity when finely powdered.

The exceedingly fine state of division in which the component grains in ordinary plastic clays exist makes it impossible to determine by the microscope very much regarding their properties.

* Missouri Geological Survey, Vol. XI, p. 104, 1896.

‡ Annual Report Mo. Geol. Surv., 1896, p. 106.

Under the microscope, with magnifying powers as high as four to five hundred diameters, hundreds of grains can easily be included in the field and still be sufficiently separated as to appear plainly as individual particles. With polarized light, those having the nature of plates all appear transparent, and only in iron-stained clays are opaque particles noticed. Between crossed Nicols, the field is entirely dark with the exception of some few of the larger particles which allow the light to pass and they are outlined as light angular spots. They extinguish and grow light again as the stage is revolved. These may be fragments of quartz, calcite, dolomite or other doubly refracting minerals, although none of them could be recognized. Tested further for the absorption of light, it is possible to obtain a slight pleochroic play of colors in some of the larger particles, but this is not so pronounced that it may be used as a distinguishing character. While it is next to impossible to make out much concerning the crystalline character of the minerals, it is also difficult, because of their minute size in most secondary clays, to say anything regarding their shape. In examining quite a series of samples, however, it is noticed as a rule, that those clays possessing a poor plasticity, or that are "short," are made up of angular, often coarse grains, and frequently bundles of these same particles which cling together and are not broken apart by the common processes of pulverizing. This was observed chiefly among unweathered shales. The plastic clays were composed of particles entirely similar in appearance to those observed in clays which were not plastic, except that they were less angular, their corners were more rounded, and it was seldom impossible to separate the grains by agitation in water. A larger proportion of excessively small grains was also present, many so very fine that under a magnifying power of five to six hundred diameters they yet appeared as mere specks of dust to the unaided eye. "As to the flattened or plate-like form of these particles, no conclu-

sive observations were made. In both plastic and short clays were noted occasional elongated fragments and these often showed parallel cleavage cracks, but it cannot be said that they were more predominant in one clay than in another. The chief differences noticed, as stated above, were the greater angularity of the grains and the existence of fewer of the very small sizes in the lean than in the plastic clays.

Whether or not the flattened grains in clays which give to them plasticity are certainly particles of kaolinite, it would seem hazardous to say from what can be learned by studying the constitution of common impure clays. Certain it must be that there are some other minerals in clays in an equally finely divided state that cannot be told from kaolinite. Common among these is quartz which exists in nature in nearly all rocks and in all states of division. Study of the geology and origin of clay deposits along with specific mineralogical examinations of the character of deposits of kaolin, which are largely free from the many impurities that are gathered up during removal and redeposition, has warranted the inference that all clays are composed essentially of fragments of kaolinite mixed with larger or smaller amounts of other mineral substances. Facts along these lines are well established and a consideration of them need not be entered into here.

Although it is not certain plasticity may be accounted for by the thin plate theory, from the facts above enumerated, it appears to approach nearer the truth than any other yet put forward, and since upon it as a basis many of the peculiarities of clays may be explained, it is safe to assume that the plate structure of clays is the principal cause of plasticity. It is probable, however, that other important factors enter. Kaolinite is a very slippery, greasy mineral of itself, which cleaves readily, and the particles thus have the property of gliding over each other when dry without great friction, as when clay powder is rubbed be-

tween the fingers. Fineness of grain also evidently has a great influence on plasticity. Importance is to be attached to the range of size of the particles. As has been shown, cementing impurities may exert an influence on plasticity. It is believed that ultimately all of these factors will be found of importance in explaining the plasticity of clay.

METHODS OF MEASURING PLASTICITY.

Accepting the thin plate theory, with the modifications noted, for the explanation of the cause of plasticity, it would appear that the strength of clays should furnish an index of their plasticity. Their strength when wet would depend upon the cohesion of the clay particles, *i. e.*, their attraction for each other, and upon adhesion between the clay grains and the thin film of water which we consider to envelop each and every grain. When dry, their strength would be due to the force of attraction among the clay particles themselves which are now in contact, and to the overcoming of friction as the particles move upon each other. Newton's law expresses the attraction of bodies for each other as "in proportion to their masses, and inversely as the square of the distances between them." When a clay is moist and plastic, attraction between particles must act through a small thickness of water. Water being a liquid substance, is mobile, and thus serves as a lubricant between the grains of clay which are allowed to move with reference to each other without friction. Water is not elastic and thus has no tendency to regain any form when it is distorted. It is for this reason that a mass of clay permeated with water may be molded by pressure into any shape desired and the shape given to it remains when the pressure is removed. This is plasticity.

According to Newton's law, all bodies exert an attractive force for all other bodies. Bodies free to move under this force approach each other until equilibrium is established. As the water

leaves a body of clay, the particles approach nearer each other under an increasing attractive force until they are in actual contact and equilibrium is brought about. So long as there is mobility in the mass of clay, that is, while the grains are surrounded with water, the latter are more or less free to move and to arrange themselves in relation to each other in the most stable positions. This arrangement is facilitated when the clay is kneaded or worked, which causes motion among the particles. Assuming the particles to be elongated and flattened in shape, there would always be the tendency for them to arrange themselves with their longest diameters parallel, hence, their broadest faces and narrowest edges towards each other. This is illustrated by the familiar experiment with a magnet and a flat piece of steel. The steel will cling to the magnet from one end or narrow edge, but if given the least chance will be drawn round in parallel position with the broadest face and longest axis of the magnet. The clay particles may be looked upon as each one a magnet attracting every particle around it. The tendency always exists, therefore, to draw all the particles in a clay mass into parallel position.

As to the amount of surface presented by the flattened particles, they may be compared with the spherical, which shape Dr. Aron* considered the constituent particles of clays to have. The sphere encloses the greatest volume with the smallest surface area. The more a body departs in shape from the sphere the larger the ratio of surface to volume becomes. The more flattened the grains, therefore, the more nearly the attracting bodies approach a plane and when arranged in parallel position the more nearly at right angles must the attracting force act. On these facts it is seen that the characteristically shaped grains of which clays are considered to be largely composed afford the

*Die Keramischen Thonfabrikate, Dr. W. Schumacher, p. 10. Notizblatt des Deutschen Vereins für die Fabrikation von Ziegeln 1873, s. 167.

best of conditions, not only for making a plastic body when wet but also a strong one when dry. The experiment with two pieces of glass between which a thin film of water is placed is known to most readers. It will be recalled that the sections of glass after being pressed together with water between them can only be parted with the greatest difficulty in any other way than by moving them upon each other parallel to the surfaces of the glass. If means are taken to part them at right angles to this direction the glass is often broken. It is this condition that exists among the flattened and polished grains of a clay that permits it to be worked and molded without rupture. The strength with which the clay grains cohere, therefore, when both wet and dry should, according to the above reasoning, be significant of the plasticity of the clay. That of the wet clay ought to furnish the more accurate idea of plasticity since we are dealing with the clay in the plastic state, and the pull necessary to rupture it is the sum of the forces required to overcome the attraction of the grains for each other and the capillary strength of the water in the clay.

The methods that have been employed to obtain a measure of plasticity may be divided into those that deal with the wet clay and those that deal with the dry clay. With the wet clay, the commonest, most practical, and for the most purposes sufficiently accurate method, is that of the feel of the moist clay between the fingers and its power to be molded as shown by mixing some of the ground clay with water and molding it in the hands. This is the field test to which the clay prospector resorts and is an efficient means of obtaining information regarding the workability of clay from any deposit. In order to have definite standards of comparison in testing large numbers of clays and to obtain concrete expressions for plasticity, several means have been devised to measure the strength of wet clays. Bischof,* a German scientist, recommended forcing the plastic clays through

* Die Feuerfesten Thone. p. 84.

a horizontal or vertical die into the shape of small pencils, and taking the length of the little cylinders thus formed before they broke of their own weight, as the measure of plasticity. The Vicat needle is used in testing wet clays in a similar manner to its use in testing the set of cement. The operation of this instrument depends upon forcing a needle into the plastic clay by the application of a known weight upon it. Langenbeck† states that if the needle, with a weight of 300 grams, penetrates to a depth of four centimeters in five minutes, the proper consistency is attained. On this same principle is based the use of a balance from one arm of which is suspended a plumb bob which is allowed to settle into the moist clay for a given period.* Weight is given to the bob by the removal of weights from the pan on the other side of the balance. By these methods it is possible to determine when a clay has reached the correct consistency for molding, but they furnish little positive information regarding plasticity unless the amount of water required is taken into consideration. Langenbeck assumes that the more plastic a clay, the more water is necessary to make it up to a moldable consistency and uses the proportion of water as a measure of plasticity. Dr. Ladd‡ describes another device for determining the strength of wet clays. The apparatus consists of two small sheet iron troughs with perforated bottoms in the center of which are placed test tube brushes in such position that when the troughs, which are mounted on wheels, are brought end to end, the ends of the brushes come together. The dry clay is sifted into the brushes and allowed to absorb moisture from below until saturated. The pull required to break the column of clay between the brushes is then measured by placing weights on a scale pan attached to one of the troughs, till the troughs part. This test

† *Chemistry of Pottery*, p. 19.

* *Clays of Georgia*. G. E. Ladd, p. 51.

‡ *Clays of Georgia*. G. E. Ladd, p. 52.

gives little direct information about plasticity but appears to have advantages for measuring the strength of clays through different stages of saturation. The tensile strength of the wet clay made up into brickettes and tested while wet and in its most moldable state with a tension machine, has been employed to some extent in determining plasticity. This practice is based upon the assumption that the clay standing the strongest pull in pounds per square inch is the most plastic. In carrying into effect such a test with the soft clay, great care would be necessary in handling and breaking the brickettes. A machine similar to the Fairbanks or Riehle cement testing machine could be used but it would have to be much lighter, more easily operated and susceptible of more delicate adjustment. As these machines are commonly constructed the weight of the lower grip is brought to bear on the brickette when the latter is placed in position and this weight is alone sufficient to pull apart nearly any clay while soft unless manipulated with unusual care. As noted earlier, however, testing in this manner, clays made up to the best working consistency should give an accurate idea of their relative plasticity. By this means is measured the cohesive strength of attraction between particles and the binding force of water which are the agents of plasticity. The drawback to the use of this method has been the lack of a device that will successfully break and record the strength of the clays.

Two plans have been followed in testing dry clays for plasticity. Bischof suggested the use of a set of "standard clays" with which all clays were to be compared by noting the relative amounts of dry clay dust rubbed off with the fingers over sheets of paper. They might also be compared by the same treatment after mixing with varying proportions of sand. This method has been employed very little if any in this country. The second plan and the one that has been followed by investigators more than any other perhaps, in this country, is to test the tensile strength

of the dried clay. The method of procedure in preparing the clays for this test and in testing itself has been considered in detail under the head of Strength of Clays, in a preceding paragraph. The results of the tests are also given.

It has been held by some that the more plastic a clay is when wet the greater will its tensile strength be when dry. If this is true, then the breaking strengths will be positive indices of plasticity by which different clays may be compared. The general results of the tests made go to show that the strongest clays are usually the most plastic, among members of the same class of clays. In comparing clays of different types, however, the method fails completely. Considered from the standpoint of workability, the well weathered shales stand well ahead of the loess, alluvial and glacial clays; yet when tested in this way the latter show in some instances tensile strengths nearly 50 per cent higher than that of the shale clays. In the accompanying table is a comparison of a few of the results which illustrate these facts:

| CLAY. | Per cent water. | Pounds per sq. in. | Pounds per sq. in. | Pounds per sq. in. | Pounds per sq. in. | Average pounds per sq. in. | REMARKS. |
|---------------|-----------------|--------------------|--------------------|--------------------|--------------------|----------------------------|--|
| Capital City | 30 | 191 | 169 | 209 | 204 | 194 | Very plastic, weathered shale. |
| Brick & Pipe | 32.5 | 149 | 179 | 148 | 161 | 171 | |
| Co. Top. | 35 | 145 | 164 | 137 | 136 | 146 | |
| | 37.5 | 140 | 121 | 118 | 192 | 143 | |
| L. C. Besley. | 22.5 | 187 | 211 | 295 | 273 | 229 | Arenaceous and more or less incoherent loess clay. |
| Bottom of | 25 | 244 | 263 | 279 | 264 | 263 | |
| Bank. | 27.5 | 214 | 310 | 216 | 195 | 234 | |
| Storm Lake | 25 | 200 | 249 | 237 | 265 | 238 | Calcareous glacial clay. |
| Brick & Tile | 27.5 | 240 | 297 | 285 | 307 | 282 | |
| Co. | 30 | 310 | 296 | 313 | 349 | 317 | |

Glacial clays are usually very plastic and have high tensile strengths, as shown in the above table. The plasticity of glacial and loess clays, while usually sufficient to make them run smoothly through a die or to mold well in the hands, is manifested in a different way from that of the weathered shales and

fire clays. The former have neither the greasy, unctuous feel between the fingers, nor the soapy, glossy surface which are characteristic of plastic shales and fire clays. Their plasticity may be designated as "sticky" or "muddy," in distinction from the smooth, soapy nature of the latter. Loess and glacial clays have not the power of cohesion that other clays possess when in the moist condition. They will roll up and pull apart readily in working, and serrated edges on the bar which comes from the auger machine are much more common when a loess clay is used than in the case of other clays. Yet the strength of the dry product, when free from these defects, is greater. The stability and endurance of the adobe (which is a material closely allied to the loess) houses and cliffs of the West attest this fact. These classes of clays are very sandy. Glacial clays are commonly very fine-grained except for the sand which they contain. Loess clays are not high in clay substance and consist largely of sand varying in size from perceptible grains to impalpable silt.

On an inspection of the results from the mechanical analyses of the loess clays, it will be noticed that the composition of those having the highest tensile strength, have the most evenly proportioned amounts of the sizes of the grains represented. Those possessing a large proportion of excessively fine particles, like the ones running high in some intermediate size of grain, are weaker than the samples which analyze more nearly even throughout the range of sizes. The difference in strength is not so pronounced nor has the number of clays tested been sufficient, to be in any way conclusive, but the results are instructive in that they suggest a possible explanation of the strength of clays based upon the proportion and range of size of the grains present. The table shows such a comparison:

| CLAY. | Loss at 230°. | SIZE OF CLAY PARTICLES. | | | | | Total per cent. | Average tensile strength-lbs. |
|--|---------------|-------------------------|---------------------|----------------------|-----------------------|----------------|-----------------|-------------------------------|
| | | Above .1 mm. | .1 to .05 mm. incl. | .05 to .01 mm. incl. | .01 to .003 mm. incl. | Below .003 mm. | | |
| Besley, Council Bluffs, top clay. | 1.55 | 8.44 | 22.10 | 49.11 | 13.44 | 10.35 | 99.99 | 149 |
| Gethmann, Gladbrook. | 2.59 | 5.19 | 22.46 | 32.04 | 14.15 | 23.55 | 99.98 | 279 |
| Besley Council Bluffs, bottom clay. | 2.04 | 1.62 | 25.28 | 29.72 | 17.85 | 23.74 | 100.23 | 214 |

SHRINKAGE.

It is well known that clays, on drying, undergo a decrease in all their dimensions. This decrease is due to the settling together of the clay particles when the water is evaporated. The fact that the larger the amount of water necessary to render a clay plastic, the greater the shrinkage is found to be, suggests that the loss of the water is the prime cause in bringing about the diminution in volume. In considering the porosity of clays it will be seen that the volume of the pore space may be measured by the amount of water that will be absorbed without changing the form of the body of the clay—that is, the water required to fill the interstices among the grains when they are touching each other at all possible points. This is called pore water and does not alter the volume of the clay. If more than is necessary to fill the pore system is present, it begins to get in between the points of contact of the clay granules, and therefore to force them apart. Soon each little particle is surrounded with a thin film of water separating it slightly from each of its neighbors. When clay is dry, the cohesion, or attraction of each clay particle for every other, holds the mass intact. When the clay is wet, and each particle is separated from every other by a film of moisture, this same force of attraction still exerts itself to hold the mass together, but because of the intervening space and the confining film of water through which it must act, the force is weakened and the particles are not held as firmly as in the dry clay. Thus surrounded and lubricated, so to speak, with a capsule of water, each

grain glides upon its neighbors when subjected to any outside pressure and the clay may be deformed and molded into any shape. If, now, more water is added than is required for plasticity, the film round each grain becomes thicker, the distance across which cohesive attraction must act is greater, so great, perhaps, that the particles no longer cling to each other, and the clay gradually melts down and loses its shape entirely. During successive additions of water the clay will increase in volume as long as it retains its shape. If the water is now allowed to evaporate from the clay, the conditions that were noted in wetting up will be repeated in reverse order. The clay will begin to shrink as soon as water begins to leave it, and will continue to do so until the film of water is removed from between all points of contact of the grains and they again settle together as closely as possible. At this stage shrinkage ceases, but there is still left in the clay all the water the pores can hold, which amounts to from 1 to 5 per cent, depending on the porosity. Generally speaking, the finer grained clays shrink more because of the large number of minute grains to be surrounded with water. But they are usually the more plastic and strong and better able to stand an excessive shrinkage without cracking.

The shrinkage of a clay may in part be counteracted by the addition of a non-plastic material as has been shown under Bonding Power. Common sand or sandy clay are often used for this purpose. This is done with clays that have such shrinkage that they will not dry safely and which will stand dilution without impairing the product. A non-plastic substance thus added to a fine-grained plastic clay acts not alone to lessen shrinkage but facilitates the evaporation of water from the clay. If the non-plastic substance used be of a refractory nature, as sand or chamotte, it serves further to maintain the form of the ware when vitrification occurs.

Fire Shrinkage.—Fire shrinkage is another important factor in the utilization of clay. By this is meant the change in volume which a clay suffers during burning. This contraction begins at red heat in all clays, and continues to vitrification, where the clay reaches its greatest density. The temperature of the vitrifying point varies with different clays. The shrinkage which begins at red heat is largely due to loss of water which was combined chemically in the clay. This water varies in per cents from 3 or 4 to nearly 14 in high grade clays. Any carbonaceous or other organic substances in the clay commence to burn out at red heat, and are a factor in the shrinkage of the clay which begins at this stage. The expulsion of these ingredients leaves the clay in a porous condition, but its contraction is not great until a sufficiently high temperature is attained that the clay commences to soften and to fill these open spaces. If the heat is carried far enough the pores are eliminated and the clay shrinks to its limit.

The practical bearing of the determination of both air and fire shrinkage comes in the application of any given clay to the manufacture of ware of certain size. It is necessary to know how much a clay when molded with a certain percentage of water, will change in volume through drying and burning. With this knowledge, dies and molds may be constructed which will form ware of such a size that when it comes from the kiln it will have the exact dimensions desired in the finished product. In this regard it would, of course, be necessary to experiment with the clay, ground to the fineness, mixed with the percentage of water and burned to the temperature required in the actual manufacture of the ware.

Shrinkage tests have been made of a number of Iowa clays. The method followed in the preparation of these clays for the tests has been outlined under Strength of Clays. After grinding and screening to the desired degree of fineness, the clays were

made up to their best plasticity, without regard to the amount of water required. While in the plastic condition, they were spread out by means of a trowel on a glass plate into a pat about one-half inch thick. From this pat were then cut pieces approximately three by one and one-half inches.

In order to determine shrinkage in drying it is necessary to measure accurately the volume of the clay when it is in the moist and plastic condition and again when the clay is dry. The difference in volume gives the per cent of shrinkage. For fire shrinkage, the difference in volume between the dry and the burnt clay is taken. Such a method determines actual change in volume, or cubical shrinkage. The linear, or shrinkage in one dimension, may be obtained by extracting the cube roots of the wet and dry volumes, taking their difference, and expressing this

difference as a percentage of the root of the wet volume. Similarly for dry and burnt clay.

The apparatus used for this determination is the Seger Volumeter. The volumeter consists (see Figure 2) of a glass jar with a capacity of about four litres, having a broad mouth and closed with a ground glass stopper. Through the center of the stopper is a circular opening into which fits the ground end of a short glass tube. The latter expands into a bulb a few inches above the stopper and is again contracted to small diameter beyond the bulb. The interior of the jar is thus open to the outside through this small tube, into which the liquid will rise when the jar is filled. Near the base of the jar is a glass stop cock, which, as

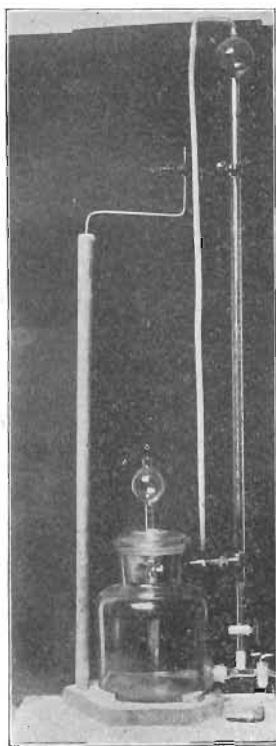

FIG. 2. The Seger Volumeter.

shown in the cut, is connected above with a long burette holding 125 cubic centimeters and graduated to tenths. The upper end of the burette expands to a bulb that serves as a reservoir for the liquid drawn upward through the burette. To the bent portion of the tube above the bulb is connected rubber tubing of convenient length to use in drawing the liquid into the burette. The glass tube inserted in the stopper of the jar has on it just beneath the expanded portion a mark, which is at the level of the zero in the graduations on the burette. When the stop cock in the lower part of the burette is open and the jar is filled with liquid up to the mark on the small glass tube, the liquid will stand at the zero point in the burette.

To use the Volumeter with any substance which water will not disintegrate, it is filled with water. If the material to be tested is such that it will slake when immersed in water, as for instance, clays that have been molded and dried, some oil is used instead. The inventor of the apparatus recommends the use of a heavy petroleum which has been decolorized by treatment with sulfuric acid and caustic soda. Ordinary kerosene oil with a specific gravity of about .8 (which must be accurately known) has been found to give satisfactory results.

After filling the jar, the burette is drawn full of the liquid by suction through the rubber tube, and held full by turning the burette valve or by means of a pinch cock on the rubber tube. The stopper is now removed and the test piece of the clay, which is still plastic and permeated with water, is carefully wiped dry of the coating film, and put in. The test pieces described earlier as approximately three inches long, were allowed to dry till, on picking up a piece endwise between the thumb and finger, the middle portion did not sag. This point was noted carefully and all samples were treated in this regard exactly the same. Care is taken not to spatter any of the liquid in placing the block of clay in the jar. In order to prevent this and to avoid breaking or otherwise marring the test piece by dropping it into the ves-

sel, a small wooden float or support (shown to the right at the bottom of the figure) by which the clay may be carefully let down into the liquid, is advantageous. This float is conveniently made with a small eye or hook near each end so it may be handled by reaching in with two stiff bent wire rods. Some such arrangement as this is found quite necessary in testing the raw clays but can be dispensed with when the clays are burned. The stopper is now replaced and by releasing the pinch cock, oil from the burette is allowed to flow back into the jar until it stands at the mark on the short tube. The volume of the clay is then indicated by the height of the liquid in the burette above the zero mark. The piece of clay is taken out and placed to dry while the Volumeter is again filled to the zero points to be ready for the next test.

When air dry the clay is heated in an air bath to 230° F. to expel all hygroscopic moisture and after weighing it is placed in a vessel of oil until saturated. This is found to require three to six hours for small test pieces approximately 3 by 1½ by ½ inches. When saturated the piece is again weighed and its volume measured as before. Having now the wet and dry volumes, the percentages of cubical shrinkage in drying is easily calculated.

In measuring fire shrinkage, the same test pieces were employed that were made use of in determining drying shrinkage. They were placed in a small muffle furnace (described under Fusibility, page 123) and burned to a temperature of seven to eight hundred degrees C. By burning at this heat, dehydration and oxidation of the clay are completed. It is about the temperature at which common, porous red building brick are burned. For the larger number of clays, vitrification has not yet begun at this heat and they are left in the most porous condition attained during any part of the burning process. In carrying on the burning of the test pieces, effort was made to bring about the best conditions for oxidation of the clay. It was usually not difficult to secure perfect oxidation throughout the small pieces that were

used. In the majority of clays, very little shrinkage occurred. In some instances an actual increase in volume was noted. This was found to be true in the case of all the loess clays which are prevailingly sandy.

In the actual carrying out of the tests, three test pieces of each clay were used from which to obtain the average shrinkage in drying. But two were employed for fire shrinkage tests. The figures given in the accompanying table are the results thus obtained.

| CLAY. | Drying shrinkage in percentages of wet vol. | Burning shrinkage in percentages of dry vol. | CLAY. | Drying shrinkage in percentages of wet vol. | Burning shrinkage in percentages of dry vol. |
|---|---|--|---|---|--|
| Flint Brick Co., bottom | 9.44 | 1.99 | Capital City Brick & Pipe Co., 4 from top | 14.88 | -.85 |
| Flint Brick Co., middle..... | 23.81 | 1.82 | Capital City Brick & Pipe Co., bottom..... | 8.44 | -2.13 |
| Flint Brick Co., top..... | 26.23 | 4.24 | Iowa Brick Co., bottom..... | 15.23 | .34 |
| Iowa Brick Co., bottom..... | 15.23 | .34 | Iowa Brick Co., 6 from top..... | 9.10 | -1.07 |
| Iowa Brick Co., 6 from top..... | 9.10 | -1.07 | Iowa Brick Co., 5 from top..... | 26.23 | .53 |
| Iowa Brick Co., 5 from top..... | 26.23 | .53 | Iowa Brick Co., 4 from top..... | 21.53 | 4.72 |
| Iowa Brick Co., 4 from top..... | 21.53 | 4.72 | Iowa Brick Co., 3 from top..... | 13.90 | -.59 |
| Iowa Brick Co., 3 from top..... | 13.90 | -.59 | Iowa Brick Co., 2 from top..... | 19.97 | -1.48 |
| Iowa Brick Co., 2 from top..... | 19.97 | -1.48 | Storm Lake Brick & Tile Co., Wisconsin drift | 27.11 | -8.73 |
| Flint Brick Co., green brick..... | 20.25 | -1.53 | Dale Brick Co., shale..... | 8.71 | -2.35 |
| Capital City Brick & Pipe Co., green brick | 23.30 | 5.66 | B. B. Jester, fire clay | 15.93 | -1.49 |
| Corey Pressed Brick Co., red burning..... | 16.94 | 2.37 | American Brick & Tile Co., plastic shale | 21.52 | 0.00 |
| Corey Pressed Brick Co., buff burning..... | 27.00 | 2.91 | LOESS CLAYS. | | |
| Granite Brick Co., top stratum... | 4.86 | -2.88 | L. C. Besley, top of bank | 6.83 | -2.47 |
| Granite Brick Co., bottom..... | 13.92 | .71 | L. C. Besley, middle | 9.62 | -1.37 |
| L. M. Harris, bottom | 17.83 | .14 | L. C. Besley, bottom..... | 13.23 | -.45 |
| Capital City Brick & Pipe Co., top | 25.79 | 6.04 | Dale Brick Co | 22.17 | -2.52 |
| Capital City Brick & Pipe Co., 2 from top..... | 10.84 | -1.19 | Gethmann Bros. Brick Co..... | 23.29 | -2.76 |
| Capital City Brick & Pipe Co., 3 from top..... | 25.85 | .47 | | | |

POROSITY.

The porosity of a clay is defined as the ratio between the volume of the clay and the open or pore space among the clay particles. It is thus a ratio of volumes and is expressed in percentage of the total volume occupied by the clay.

Porosity of any body which is composed of an aggregate of particles depends on the size and shape of these particles. If

they are all spherical and of the same size, as in a mass of shot, porosity is at its maximum. The more they vary in shape from the sphere and the greater the range in size, in general the lower the porosity. Clays have a great range in size and shape of constituent grain. It is evident that if a clay is made up of multitudes of small mineral particles of multifarious shapes and sizes, it is impossible for them to be in contact with each other at all points, even when the clay is in the most compacted condition. That they are not is evidenced by the fact that dry clay absorbs water, which shows that it is porous. The microscope also reveals the shape and size of grains to be variable. Some are flat and rounded, others are elongated or sharp and angular in outline. The size of these grains ranges from sand which is visible to the unaided eye, to such minute particles that the highest power of the microscope fails to resolve them. It is clear that such a mass of grains, varying as they do, could not settle together in such a way as to fill all the space which the total volume of the clay occupies. That is, when the particles are in contact at all possible points, there are still small spaces left between them, and these spaces connect with others, thus forming a pore system throughout the clay mass. Thus the very smallest particles fill in the spaces between the larger grains. It is difficult to say whether one clay is more porous than another if nothing is known as to the size and shape of the grains. One may absorb water greedily because of its coarse grain and would be called a porous clay. Another, while it may not take up water with such avidity at first, may ultimately require just as much to saturate it as the former coarse-grained one. The actual amount of pore space in the two might be the same, and their differences with respect to water absorption would probably be due largely to form and size of the individual mineral particles of the clay.

On the porosity of clays depends largely the amount of water required to make them plastic. On the water of plasticity depends the shrinkage which clays undergo in drying. The ability

of clays to withstand rapid drying without injury is dependent partly on the shrinkage which they suffer. If the pores of the clay are large, water may be absorbed rapidly and likewise given off readily. If the pores are small, moisture is both absorbed and evaporated slowly.

Porosity is a very important physical factor in burnt clay wares. Unless completely vitrified, all clay products are more or less porous. As with building stones, the value of burnt clay for structural purposes depends on its ability to withstand the conditions under which it is placed, especially the influence of weather. All unvitrified bricks absorb water from the atmosphere and the earth; whether with readiness and in quantity depends upon their porosity and fineness of grain. The freezing of contained moisture in the pores of the brick imposes one of the most strenuous tests which a brick must undergo. If the pore system is fully developed and the pores are large the brick will usually suffer little deterioration, as the pressure exerted by the expansion of water on freezing will be relieved by the exudation of small ice crystals from the pore openings at the surface of the clay. That is, the small capillary tubes throughout the clay are of such size that the expansive force at freezing pushes the many little columns of ice outwards instead of subjecting the brick itself to the strain. If the clay is very fine-grained (as has been shown, its porosity may be the same as that of the open-textured clay) its capillary system will consist of very small openings, tubes so tortuous, perhaps, that no movement of the ice spicules is possible when the water congeals in the pores. In this instance, the expansive force of the freezing water is directly exerted to separate the particles and is effective in breaking down the structure of the clay. If a clay is an exceedingly close-textured one, its porosity is apt not to be so pronounced, and, as in the case of many of the best grades of dry press face brick, will not absorb enough water to become a disrupting agent on freezing. Thus it is obvious that there are two limits of safety,

the strong clay with low porosity, and the coarser clay with large pore spaces and a well developed pore system, if both are equally well burnt, are but little affected. The determination of porosity thus becomes of importance with both the dry and the burned clays. In order that the results may be of the greatest practical value, however, the clays should be dealt with after receiving the treatment to which they are subjected in the actual processes of manufacture.

The porosity of granular bodies is often found by noting the weight of water absorbed and comparing this with the weight of the dry material. Since, however, the porosity is a relation between volumes, this method does not measure true porosity. Buckley* has fittingly termed the result obtained by the above process the "ratio of absorption", and it should not be confused with true porosity, which is the volume of pore space compared with the volume of the clay. Porosity is obtained by saturating the body with some liquid whose specific gravity is known. With dry clays it is impossible to use water because of its slaking effect. In the tests made for this report, kerosene was employed for saturating the raw clays, after determining very carefully its specific gravity. For the burned samples, distilled water was used and its specific gravity taken as unity.

The porosity determinations were made by the aid of the Seger Volumeter described under Shrinkage. Porosity was measured on the samples used for shrinkage determinations. The volume of the test pieces was measured after the clay was dry. The pieces were then allowed to stand in the oil used until saturated. (See Shrinkage.) The dry weight and that after saturation were recorded. Let the volume of the dry testpiece be called V ; g , the difference in weight between the dry and the saturated piece, or, in other words, the weight in grams of oil absorbed; s , specific gravity of the oil. Porosity is obtained from these data by dividing the weight of oil absorbed, g , by

*Building and Ornamental Stones. Bulletin No. 4, Wisconsin Geol. Surv., p. 69.

its specific gravity, s , and this quotient by the volume V , of the test piece. The last quotient multiplied by 100 gives the percentage of porosity. In formula, $P = \frac{g}{s} \frac{100}{V}$. For the porosity of the burnt clay with which water could be used for saturation, precisely the same plan was followed. The specific gravity of distilled water at ordinary temperatures was taken as unity, it was thought, without the introduction of any appreciable error; s , therefore, disappears from the formula; g becomes cubic centimeters, and the expression reduces to $P = \frac{g}{V} \frac{100}{1}$, which is a direct comparison of the volume of water absorbed with the volume of the clay.

The results given in the table below were obtained by taking the average of three determinations for each of the clays in the unburned condition; and the average of two samples of each of the clays after they were burned at a temperature of 750° to 800° C.

| CLAY. | Porosity of un-burned clays. | Porosity of burned clays. | CLAY. | Porosity of un-burned clays. | Porosity of burned clays. |
|-------------------------------------|------------------------------|---------------------------|--|------------------------------|---------------------------|
| Flint Brick Co., bottom of bank.... | 30.04 | 26.94 | Capital City Brick and Pipe Co., | | |
| Flint Brick Co., middle | 23.00 | 24.74 | 3 from top | 17.00 | 20.81 |
| Flint Brick Co., top | 17.31 | 22.31 | Capital City Brick and Pipe Co., | | |
| Iowa Brick Co., bottom of bank.... | 28.69 | 33.45 | 4 from top | 25.13 | 27.29 |
| Iowa Brick Co., 6 from top | 26.04 | 27.64 | Capital City Brick and Pipe Co., | | |
| Iowa Brick Co., 5 from top | 17.96 | 21.41 | bottom stratum..... | 24.59 | 26.64 |
| Iowa Brick Co., 4 from top | 29.57 | 29.57 | Potter's clay, Co'esburg, Iowa..... | 28.36 | 25.51 |
| Iowa Brick Co., 3 from top | 25.73 | 28.99 | Clermont Brick and Tile Co., white | | |
| Iowa Brick Co., 2 from top | 17.43 | 21.39 | burning | 22.66 | 39.63 |
| Flint Brick Co., green brick | 23.20 | 23.47 | Storm Lake Brick and Tile Co., | | |
| Capital City Brick and Pipe Co., | | | Wisconsin drift | 19.27 | 20.83 |
| green brick | 21.83 | 22.15 | Dale Brick Co., shale..... | 28.98 | 31.02 |
| Corey Pressed Brick Co., red burn- | | | B. B. Jester, Danville, Iowa, fire clay. | 20.35 | 23.66 |
| ing clay..... | 30.10 | 33.24 | American Brick and Tile Co., plas- | | |
| Corey Pressed Brick Co., buff burn- | | | tic shale | 26.71 | 30.46 |
| ing clay..... | 28.10 | 29.59 | | | |
| Granite Brick Co., top of pit.... | 23.00 | 25.57 | | | |
| Granite Brick Co., bottom of pit... | 22.41 | 22.95 | | | |
| L. M. Harris, Rockford, Iowa..... | 24.33 | 34.78 | | | |
| Capital City Brick and Pipe Co., | | | | | |
| top | 30.80 | 27.69 | | | |
| Capital City Brick and Pipe Co., | | | | | |
| 2 from top | 25.25 | 26.49 | | | |

LOESS CLAYS.

SPECIFIC GRAVITY.

Specific gravity has not been shown to be a factor of especial importance in the economic treatment of clays. According to the conception that specific gravity is a function of porosity, it is considered to have a bearing on the fusibility of clays. The more compact and non-porous the clay, other things being equal, the higher the specific gravity and the lower the fusion point. On this basis, the clay might have one specific gravity as it came from the bank and this would change with each variation in manipulation. The ground clay would have a different specific gravity from the undisturbed clay in the bank. If clays were to be used in their natural state for building purposes, as are other classes of quarry products, a knowledge of their specific gravity based on the above conception, might be of some value as indicating relative mass. This is not, however, the true specific gravity of the clay, which depends alone on the minerals composing it and is independent of porosity. From this standpoint, the specific gravity of a clay is constant no matter what condition the clay may have.

Pure kaolinite has a specific gravity of 2.6. Quartz sand has a specific gravity of 2.65. The iron minerals occurring in clays are all heavier than the above constituents. Lime carbonate is likewise somewhat heavier. The principal impurities in clays that are lighter than the essential constituents are feldspar, calcium and magnesium sulfates, alum and soluble salts of potassium and sodium. Other salts of low specific gravity occasionally occur but seldom in sufficient quantity to appreciably modify the weight of the clay. In fact, the proportion of the substances mentioned as of less specific gravity than kaolinite is usually not large, so that, viewed from the point of mineral composition, most clays should have specific gravities very close

to that of kaolinite itself. Clays high in iron compounds will of course have higher specific gravities. This is found in general to be true, more of them, however, being below 2.6 than above, some departing so abnormally that it is impossible to explain such departure by a study of the mineral constitution of the clay. This is especially true of the loess clays.

The Seger Volumeter described earlier was employed for specific gravity determinations. Only the data collected in the measurement of porosity and shrinkage were required to calculate specific gravity. This was calculated on the same samples used to determine porosity.

If we allow G to stand for the actual weight or mass of the test piece when dry, this value divided by the volume of the latter in cubic cm, $\frac{G}{V}$, would give specific gravity if the clay were entirely non-porous. But since V represents apparent volume, that is, clay plus pore space, in order to get the real volume of the clay present, this volume must be corrected for pore space. 100 per cent less the percentage of porosity, P , gives the percentage of the apparent volume which is actually occupied by the clay particles. This difference multiplied by the already obtained volume of the clay gives the space in cubic centimeters really occupied by clay. The weight of the clay sample divided by the corrected volume equals the true specific gravity. This is expressed in formula thus:

$$\frac{G}{V (100 \text{ per cent} - P)} = \text{Sp. Gr.}$$

| CLAYS. | Specific gravity of unburned clays. | Specific gravity of burned clays. |
|---|---|--------------------------------------|
| Flint Brick Company, bottom..... | 2.40 | 2.24 |
| Flint Brick Company, middle..... | 2.51 | 2.46 |
| Flint Brick Company, top..... | 2.41 | 2.46 |
| Iowa Brick Company, bottom..... | 2.36 | 2.41 |
| Iowa Brick Company, sixth from top..... | 2.37 | 2.34 |
| Iowa Brick Company, fifth from top..... | 2.45 | 2.42 |
| Iowa Brick Company, fourth from top..... | 2.40 | 2.54 |
| Iowa Brick Company, third from top..... | 2.46 | 2.42 |
| Iowa Brick Company, second from top..... | 2.53 | 2.51 |
| Flint Brick Company, green brick..... | 2.52 | 2.42 |
| Capital City Brick and Pipe Company, green brick..... | 2.51 | 2.49 |
| Corey Pressed Brick Company, red burning..... | 2.54 | 2.52 |
| Corey Pressed Brick Company, buff burning..... | 2.54 | 2.49 |
| Granite Brick Company, top..... | 2.25 | 2.23 |
| Granite Brick Company, bottom..... | 2.42 | 2.43 |
| L. M. Harris, bottom..... | 2.56 | 2.52 |
| Capital City Brick and Pipe Company, top..... | 2.64 | 2.50 |
| Capital City Brick and Pipe Company, second from top..... | 2.48 | 2.39 |
| Capital City Brick and Pipe Company, third from top..... | 2.53 | 2.50 |
| Capital City Brick and Pipe Company, fourth from top..... | 2.45 | 2.39 |
| Capital City Brick and Pipe Company, bottom..... | 2.40 | 2.32 |
| Cole-burg, potter's clay..... | 2.62 | 2.37 |
| Clermont Brick and Tile Company, white burning..... | 2.58 | 2.54 |
| Storm Lake Brick and Tile Company, Wisconsin drift..... | 2.42 | 2.24 |
| Dale Brick Company, shale..... | 2.48 | 2.41 |
| B. B. Jester, fire clay..... | 2.49 | 2.42 |
| American Brick and Tile Company..... | 2.51 | 2.42 |
| LORSS CLAYS. | | |
| L. C. Besley, top..... | 2.34 | 2.27 |
| L. C. Besley, middle..... | 2.32 | 2.28 |
| L. C. Besley, bottom..... | 2.40 | 2.23 |
| Dale Brick Company..... | 2.44 | 2.35 |
| Gethmann Brothers Brick Company..... | 2.41 | 2.28 |

FINENESS OF GRAIN.

Much can be told as to the fineness of grain of clays by their appearance, the way in which they slake in water, and by the feel of the wet clay between the fingers. Such tests as these can be applied readily and rapidly in any case and to the clayworker usually give all the information that is required regarding the grain of the clay and its working plasticity.

The fineness of the grain of clays has an important bearing on plasticity, shrinkage, porosity, rapidity with which they can be dried and burned and their fusibility. Some have considered fineness alone the cause of plasticity. It has been previously shown under Plasticity, however, that mere fineness does not account entirely for this property but that the plate or scale structure of the grains is of primary importance, while fineness is probably secondary and its effect on plasticity depends upon this first factor. Nevertheless it may be held as a general rule, that the finest grained clays are the most plastic or, in the usual order of observation, the most plastic clays are found to be the finest grained. Under Shrinkage and Bonding Power has been pointed out the effect of size of grain on the change in volume in drying and burning. In general, fine-grained, and therefore, plastic clays shrink the most. To this rule there are, however, very frequent exceptions. It may be stated that at present too little is known about the mechanical constitution of clays to account for many of these exceptions to the rule. It is believed that they are due mostly to the range of the sizes of the grains represented and in some degree to the shape of the particles. The porosity of clays is likewise influenced by the fineness of grain but more, perhaps, by the shape and range of the sizes. The rapidity with which a clay can be dried depends upon the development of its pore system and upon the amount of shrinkage. If the clay is fine-grained, its pores will be small and the water which leaves it will find difficulty in reaching the surface. The outer portions of the clay shrink around a still moist and expanded interior which often causes checking and cracking. In a coarse-grained clay the water readily passes outward, the whole mass of clay shrinks together, and, other things being the same, cracking is much less apt to ensue. There is, though, always the matter of the coherent strength of the clay to be kept in mind. Oftentimes, clays of very fine grain and high shrinkage are rapidly and suc-

cessfully dried because of their inherent strength which tides them over a period of considerable strain. Coarse-grained clays, if they lack this strength, are apt to check if subjected to the least possible amount of drying strain and, therefore, require very careful handling. There are two ways in which clays are affected by the rising temperature in burning. The temperature of the body of clay itself must be raised to that of the atmosphere surrounding it. This is accomplished by conduction through the clay by contact of one particle with another. Clay is a poor conductor. If the heat is raised rapidly, checking may be brought about by differential expansion due to difference in temperature in parts of the same piece of clay. This is especially important with large and thick pieces of ware. Solids are usually the best conductors of heat, because their particles are in most intimate contact. A close-textured clay in which the particles are closely packed together would, therefore, conduct heat most readily; while there would be more danger of injury from this cause to a coarse-grained clay, because of the large pore spaces and the lack of inherent strength. Secondly, by the giving off of combined water and other gases. This takes place at red heat and above and would subject the clay to a set of conditions similar to those of drying. With a well defined pore system as in coarse clays, the gases easily pass out. Their passage is more obstructed in fine-grained clays by the small size of the pores and the clay is subjected to a strain. The limitations with regard to the strength of the fine and coarse-grained clays hold in this instance as in the case of drying strains. It is shown under Fusibility that ordinary clays are more fusible the finer their grain. This is explained by the greater intimacy of the contact which the fine grains have, and especially if they are of varying composition, by the fluxing effect of fusing particles on those around them.

The mechanical composition is thus of importance in the explanation of many of the properties of clays. A fuller knowledge than is to be obtained by the tests outlined at the beginning of the chapter, is to be had by making mechanical analyses of the clays. There are two chief methods by which this is accomplished. They are both gravity methods, one depending upon the ability of a current of water of given velocity to carry out a certain range of particles; the second upon the settling of a range of sizes in a certain period from quiet water in which the clay particles are suspended. The former is illustrated by the Schoene apparatus, a description of which may be found in many of the standard German text-books on clay working* and in volume XXXIII, page 436, of the *Clayworker*, published in this country. The latter is exemplified in the Whitney† process, which was devised in the mechanical study of soils.

The process employed in the analysis of clays for this report is a modification of the Whitney process. A settling can of tinned sheet iron one foot high and six inches in diameter was made. It was provided with a stop cock three inches from the bottom. Before use could be made of the instrument, standardization was necessary. According to Whitney's method, the following terms for the different sizes of grains are used: .1 to .05 mm. in diameter, very fine sand; .05 to .01 mm., silt; .01 to .005 mm., fine silt; below .005 mm., clay. In the analyses made, this nomenclature was followed with the exception that all particles below .003 mm. are included as clay. This was done because .003 mm. corresponded with the smallest micrometer division in the microscope used for measurement. Only loess clays have been analyzed. It is probable that the above classification would require much modification to express the true composition of plastic shales and fire clays, especially if it is attempted to sep-

* *Die Feuerfesten Thone*. Dr. C. Bischof, p. 79.

† *Mechanical Analysis of Soil*. Bulletin Department of Agriculture.

arate clay substance from the other constituents. Thus Seger* includes under the head of "clay substance" all material from .01 mm. down. It is necessary to standardize the process according to the class of clays investigated. Thus for kaolins, which are largely clay substance, a still broader range of particles would be included as clay. It is ostensibly impossible to establish fixed lines between particles which are real clay and grains of other minerals based on size alone, and this is not necessary. All that is desired is to separate clays into a series of sizes of grain and the points at which the divisions are made are entirely arbitrary.

In order to analyze the clays according to Whitney's classification, it must next be determined how long periods are required for the different sizes of grains to settle under the conditions which exist in an instrument of the given dimensions. To do this, a sample of clay, the amount to be later used in analysis, was placed in the settler, agitated, then allowed to settle quietly. At frequent intervals, measurements of the maximum grains still in suspension were made by means of a petrographical microscope provided with the eye-piece micrometer; and, after tapping off the water, of the range of particles that had settled in the observed length of time. By experimenting in this way, the following periods were established for the several sizes: for particles above .05 mm. in diameter, 5 minutes, 4 minutes, 3 minutes, 2 minutes, 2 minutes, 1.5 minutes, 1.5 minutes; .05 to .01 mm. in diameter, 11 minutes, 10 minutes, 9 minutes, 9 minutes, 9 minutes, 8 minutes, 8 minutes; .01. to .003 mm. in diameter,, 20 minutes, 19 minutes, 18 minutes, 18 minutes, 18 minutes, 17 minutes, 17 minutes. At the end of each settle the water was tapped off, carrying all suspended material with it. At the close of each series of settling periods, the water was practically clear.

In the execution of the work, a sample of 50 grams of the air dried clay was weighed out and dried at 230° F. in an air bath

* Collected Writings. Translation. Am. Ceramic Society, Vol. 1, p. 42.

for three-quarters of an hour, then reweighed for hygroscopic moisture. The clay was then placed in a large beaker of water, heated to boiling and held at that temperature for one-half hour. This was done to separate the grains from one another. The loess clays disintegrated very readily and completely by this treatment, but it was impossible to reduce the plastic shales in this way. Whitney employs a "shaker" in which the soil solutions are vigorously kept in motion for days at a time if necessary, until disintegration is complete. Some arrangement of this kind must be used in the treatment of plastic clays.

The clay sample is next thrown onto a 150-mesh sieve and thoroughly washed through by water from a small hose under strong hydrostatic pressure. All particles above .1 mm. in diameter remain on the sieve, are dried and weighed. The clay solution is now poured into the settling can with the outlet closed, which is then filled with water from the hydrant to one-half inch of the top. For an agitator, a piece of wire gauze was made to fit the interior of the can. To the center of this was attached a stiff wire rod so that the gauze could be drawn rapidly upwards through the liquid several times, finally coming to rest on the bottom. By this means all the clay is brought into suspension without the generation of any well defined currents which would tend to buoy the particles up, as would be the case if circular currents were started by stirring. Vertical currents are not noticeable and the material settles in practically still water. At the end of each of the periods of settling given above the tap was opened and the supernatant water above the aperture with all the particles still suspended flowed rapidly out into a settling tank or into separate receptacles. The settler is again filled and the operation repeated. When the first series of settles is completed, viz., 5, 4, 3, 2, 2, 1.5, 1.5 minutes, the sand remaining in the settler is removed, dried and weighed as "very fine sand" and ranges in diameter from .1 to .05 mm. The

water which has accumulated, approximating nine or ten gallons, is best allowed to stand in a large tank until all suspended matter has settled to the bottom. This requires from 36 to 40 hours. The supernatant, clear liquid is then siphoned off and the slime again placed in the settler. To obtain the succeeding sizes of particles, the process of settling is simply repeated as described above, using the longer periods of time as the particles become smaller and smaller.

Care is to be exercised in all parts of the process, especially in the matter of removing the slimes from the settling tank and the various sands from the settler. In spite of all precaution an analysis will usually total more than 100 per cent. This is in part accounted for by the presence of soluble salts if hydrant water is used. This portion of the error could be corrected by making use of distilled water. In the present work, care was taken to evaporate substantially the same amount of water in drying each of the sands so the same correction could be applied to the weight of each one. In each case, therefore, the excess was proportioned among the separate weights so as to make the total 100 per cent.

To furnish an idea of the accuracy it is possible to attain in this work, and as an example to illustrate the degree to which the work of one person may be made to check that of another, the following comparison is given. The first analysis was made by the author and the second a year later of the same sample by Mr. T. L. Green, a student in the ceramic laboratory at the Iowa State College.

| | II. | I. |
|-------------------------|-------|-------|
| Hygroscopic water | .20 | 1.55 |
| Above .1 mm | 1.38 | 3.44 |
| .1 to .05 mm | 26.65 | 22.10 |
| .05 to .01 mm | 46.71 | 49.11 |
| .01 to .003 mm | 12.02 | 13.44 |
| Below .003 mm | 13.03 | 10.35 |
| Total | 99.99 | 99.99 |

In the following table is a list of the analyses made.

| CLAYS. | Loss at 230° | SIZE OF PARTICLES. | | | | | Total per cent. |
|-----------------------------|--------------|--------------------|---------------------|----------------------|-----------------------|----------------|-----------------|
| | | Above .1 mm | .1 to .05 mm. incl. | .05 to .01 mm. incl. | .01 to .003 mm. incl. | Below .003 mm. | |
| L. C. Besley, top clay..... | 1.55 | 3.44 | 22.10 | 49.11 | 13.44 | 10.35 | 99.99 |
| L. C. Besley, middle..... | 1.65 | .62 | 23.38 | 40.40 | 16.17 | 17.77 | 99.99 |
| L. C. Besley, bottom..... | 2.04 | 1.62 | 25.26 | 29.72 | 17.85 | 23.74 | 00.23 |
| Dale Brick Company..... | 1.41 | 27.42 | 12.84 | 14.39 | 10.57 | 33.35 | 99.98 |
| Gethmann Bros..... | 2.59 | 5.19 | 22.46 | 32.04 | 14.15 | 23.55 | 99.98 |
| Cameron Bank, Ames.... | 3.77 | 0.00 | 22.32 | 35.98 | 12.87 | 25.06 | 100.00 |

FUSIBILITY.

A substance is said to be fusible when, by subjecting it to a certain set of conditions, it may be made to change from the solid to the liquid state. The process of passing from solid to liquid form is known as fusion. The melting of ice to form the

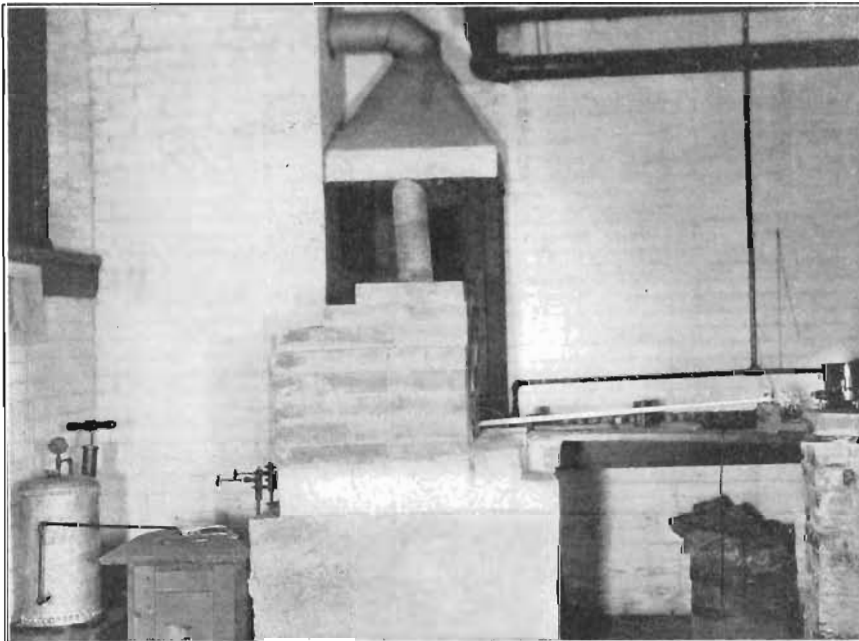

FIG. 3. Hoskins furnace with Le Chatelier's pyrometer for making fusibility tests on clays.

liquid, water, is as truly fusion as is the phenomenon which takes place in the glass pot in the reduction of the mechanical mixture of glass forming ingredients to a vitreous and molten mass. The difference lies only in the amount of heat required to bring about this change in physical character.

Theoretically, all elements and mineral substances, that is, all inorganic compounds of definite chemical composition, are capable of existing in the three conditions, solid, liquid and gaseous. Substances are found in nature in all these three conditions. They so exist because under their surroundings they are stable in the condition in which they occur. If their environment is altered, they may be made to assume both of the other physical states. A solid, for example, may be made to pass into the liquid condition and later to the gaseous state.

The two important factors which influence and limit the physical condition of any definitely composed substance are temperature and pressure. Under ordinary temperatures and pressures, a body may exist as a solid, while if these are varied, the body will change to a liquid and even a gas. Theoretically, then, it is possible to make all substances assume these three conditions if only they can be subjected to the correct combination of heat and pressure. Thus, this was the problem that had to be solved in the liquefaction of air from the gaseous state as it was also the problem for solution in the liquefaction of lime from the solid condition.

Considered from our present standpoint, however, the pressure factor may be disregarded and the application of heat under ordinarily obtaining atmospheric pressures taken as the all-important condition. In clays, none but solid substances are dealt with so far as fusibility is concerned, and it is always at temperatures above the ordinary that fusion occurs. There is also another limiting factor which should be mentioned in considering the fusion of solids in general. That is, the tendency

of many compounds to decompose before reaching the point of fusion. This tendency is often so pronounced that it is impossible to reduce many minerals to the liquid state by the application of heat alone. This is especially true of those compounds which consist of a basic oxid in combination with a gaseous element or radical and all minerals that hold water in a state of chemical combination. On heating, these break up, giving off the gaseous components before fusion occurs.

Clays are not of definite chemical composition. They are made of a mixture of minerals, each definitely composed and possessing a fairly well marked melting point of its own. The proportions of these ingredients vary, no two clays having exactly the same constitution. When such a mixture is subjected to a rising temperature, it is evident that the changes which take place are different from those noted in the case of a simple mineral, viz., the transition, *at a certain temperature*, from solid to liquid. This could not be true of any aggregation of minerals in which no two, perhaps, possess the same melting point. As the temperature is raised, the fusion points of the several minerals in the clay are successively reached and they melt, in contact with all surrounding particles of different composition and more refractory nature. As a result, this liquid, which we may now think of as existing in, and partially filling the pores of the clay, begins to attack and combine with the still unfused portions. Most amenable to attack, of course, would be those substances next in order of fusibility which, being brought into chemical combination, would no longer possess an individual melting point, but succumb to the effects of the heat at a lower temperature. This action proceeds as one after another of the clay constituents is brought into fusion until finally the whole clay is reduced to the molten condition.

It will be noticed that the process of fusion is one based upon familiar chemical laws. It is well known that chemical action

rarely takes place between solids, no matter how finely ground and well mixed or how intimately in contact they may be. If one of the reacting substances is a liquid, or a gas, chemical combination is greatly favored. If they are both liquids, e. g., in solution, or both gases, reaction proceeds most expeditiously. So long as the ingredients of a clay remain as solids, chemical action among them is slight, although heated to elevated temperatures. As soon, however, as melting of any ingredient takes place, chemism between this liquid and the solid components with which it is in contact becomes much stronger and the action following is that of a liquid attacking a solid.

The natural law governing chemical action among substances in different physical states is not an inflexible one, nor one to which there are no exceptions. It is not to be considered that in a mixture of minerals such as compose common impure clays, no chemical effects are brought about between the fluxing constituents and the clay base until the melting points of each of the fluxes is reached. That is, it is not necessary that actual fusion overtake each fluxing ingredient before it exerts any chemical influence on its neighbors. It is known that some of the most common of fluxes, as lime and magnesia, are, when heated alone, infusible at all temperatures short of the oxy-hydrogen flame or the electric arc. Yet, when heated in contact with silica and alumina silicates to temperatures ordinarily attained in common kiln practice, they become very active fluxes. They must be looked upon as possessing caustic properties at these comparatively slightly elevated temperatures which enable them to react in the solid form. They commonly occur in clays in combination with other elements which at high heats are driven off as gases. The loss of the latter may leave the base in a more or less nascent state in which it is more susceptible to chemical union than it normally would be.

In the fusion of elementary substances or simple mineral compounds, the heat necessary to effect the change is utilized entirely in bringing the temperature of the substance to its fusion point and, at this temperature, in converting it to the liquid condition. The temperatures of fusion for the elements and for many compounds are fixed and invariable. As a rule, when the melting point of a substance is reached, the temperature does not rise with further application of heat but remains stationary till all of the solid has assumed the liquid form. It is evident, since heat is continually supplied and the temperature of the body does not rise, that there must be a consumption of heat due to the change which is taking place. It is found that this is true and for every substance of definite molecular proportions that can be made to change its state, the amount of heat consumed in this change is always the same for the same amount of the substance. The heat units thus stored up are not again freed so that they are evident to the senses until the liquid returns to the solid form. This so-called "latent heat" is an important constant both in the determination and economic application of many chemical compounds.

If an aggregation of minerals is heated to fusion, the heat applied will be used up by the absorption of each component till its fusion point is reached; by their absorption of latent heat in fusion. Further than the mere consumption of heat due to melting, there are, where a number of elements are fused together, additional heat units required to supply the necessary energy for chemical union. A clay fused to a more or less homogeneous glass is looked upon as a chemical compound formed by the combination of the separate elements of the raw material. Thermo-chemical study has shown that all chemical reactions involve the consumption or evolution of certain amounts of heat. For given proportions of the elements required to complete a reaction, the heat evolved or consumed is always the same.

Those reactions which consume heat are known as endothermic reactions and continual addition of heat from an outside source is requisite to their propagation. Reactions in which heat is evolved are said to be exothermic, and when once started continue by their own thermal generation. A common example of the latter is the combustion of coal in which heat is generated by the union of the carbon of the coal and the oxygen of the air.

The former class of reactions, those in which the consumption of fuel is necessary to carry them on, is very commonly exemplified in the metallurgical industries and, of the chemical reactions which occur in the fusion of clays, it may be said they are all, as far as is known, endothermic. Here, then, as was intimated in the last paragraph, is another factor in the consumption of the heat applied in burning clays to vitrification. It is bound up irretrievably in the different compounds that are formed among the clay minerals. A clay thus brought into the fused condition has absorbed a considerable amount of heat in the ways indicated. After cooling, if the vitrified mass be again subjected to the heat required to melt it, it will be found that it will not only take actually fewer heat units to bring it to a similar state of fusion but that it will fuse at a slightly lower temperature. The reason for this is obvious from the facts that no heat units are necessary to bring about chemical combination and, having once been melted, it is more nearly homogeneous in all its parts and will therefore respond more readily, due to its better conductivity.

Summing up briefly the preliminary statements thus far made regarding the principles upon which the fusion of mineral substances depends, we have:

Elements, or compounds of definite composition, will, when heated, change to the liquid state at temperatures which under standard conditions are essentially fixed.

In passing from solid to liquid condition, heat units are absorbed at the temperature of fusion, which do not raise the temperature of the melting material. The amount of latent heat thus bound up is always the same for the same mass of a given substance.

The fusion of a mixture of elements or compounds, each of which has a fairly definite melting point and latent heat of its own, is brought about by chemical reactions among the ingredients of the mixture by which the latter is reduced to a homogeneous mass.

The heat necessary to effect the fusion of a mineral mixture such as a clay, is utilized in the following ways: (a) in raising the temperature of each component to its fusion point—the amount varying with the specific heat; (b) as latent heat, in converting the fusible constituents to the liquid form; (c) in bringing about chemical union among the several ingredients of the clay.

EFFECT OF CHEMICAL COMPOSITION ON FUSIBILITY.

Clays are composed essentially of the hydrous alumina silicate, kaolinite, having the formula, $\text{Al}_2\text{O}_3, 2\text{SiO}_2, 2\text{H}_2\text{O}$. As accessories, there commonly occur compounds of the alkalis, soda and potash; of the alkaline earths, lime and magnesia; and of iron compounds. Small amounts of some of the less common minerals occasionally occur. Some clays carry small proportions of manganese, titanium and even phosphorus, but these are seldom present in sufficient quantity to be of importance in any way.

In the present discussion on the fusibility of clays, only the common fluxes enumerated above will be taken into consideration. In fact, chemists, in the analysis of clays, seldom determine other than the ones mentioned, unless for some special purpose. It will be necessary to consider the fluxes only as they act in rendering a clay fusible. That is, since iron, for instance, is

always considered as entering into silicate combination in the ferrous condition, no matter in what form it is found in the raw clay, its fluxing power will be considered as due to the action of the ferrous oxid, FeO. Likewise, lime enters into combination as CaO; magnesium as MgO, sodium as Na₂O, and potassium as K₂O.

As a general statement, it may be said that the higher the proportion of these fluxes in a clay, the lower the temperature required to melt the clay. That is to say, the farther its composition varies from that of pure kaolinite, due to the presence of these impurities, the more fusible will it be. If this variation is due to one or several fluxes, the fusibility is always increased but the ability of the different impurities to exert a fluxing influence is different. It requires more of one than of another to bring about the same degree of fusibility. The temperatures, likewise, at which they become active vary through a considerable range.

Until 1868, little was known concerning the relative importance of fluxes in effecting the fusion of clays. In this year, Richters, a German, formulated the results of a protracted series of experiments into three laws, as follows:

(1) The refractory quality of a clay of any given proportion of silica and alumina is most influenced by the fluxes in the following order: MgO, CaO, FeO, Na₂O, K₂O.

(2) Chemically equivalent quantities of these oxids exert equal influences on the refractoriness of a given clay. That is, 40 parts of magnesia, 56 parts of lime, 72 parts of ferrous oxid, 62 of soda, 92 parts of potash, will each produce an equal degree of fusion in the same quantity of the same clay.

(3) If a number of fluxes are present in a clay, the fusibility produced will be proportional to the sum of their chemical equivalents. For example, a clay with the formula, $\frac{.15K_2O}{.15CaO} Al_2O_3 \cdot 2SiO_2$ should fuse at the same temperature as one of the composition,

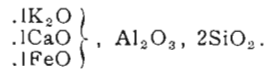

More recent investigators have tested the truth of these laws and have found them to be a good working basis for studying the refractoriness of clays. In the establishment of the laws, Richters made use of mixtures of silica and alumina to which he added certain known proportions of the fluxes. The action under heat of these mixtures was noted first, by using silica and alumina in the proportion in kaolinite. Second, he added a higher content of silica than is found in kaolinite and made a similar set of observations.

It is known that silica and alumina in kaolinite proportion (102 : 120) have a melting point of approximately 1830° C., cone 35 of Seger's scale. When silica is added to this in increasing proportions the fusion point is lowered until the ratio $Al_2O_3, 17SiO_2$ (1 : 10) is reached. Beyond this, which fuses at Seger cone 26, or about 1650°, the mixture becomes more refractory with increase of SiO_2 . We see that silica in this instance acts as a flux to alumina, and in all high grade clays an excess of silica is always detrimental to the refractory qualities of the clay. Further, the presence of silica in a clay mixture along with the other fluxes has a modifying effect on the action of the more fusible ones, in general, accelerating their action.

More complete experimentation has shown that where free silica exists the order of fluxing power of the oxids is somewhat altered. Dr. Cramer of Berlin published in 1895* an investigation of Richters' laws in which he announced their verification as far as their effect on kaolinite is concerned. In the presence of free SiO_2 , however, the order of fluxing power he found to be as follows: $FeO, MgO, CaO, Na_2O, K_2O$. That is to say, in a clay containing free SiO_2 , chemically equivalent quantities of the fluxes do not produce equivalent effects, 72 parts of ferrous

*Thon Industrie Zeitung, 1895, Nos. 40-41.

oxid being able now to do more work than 40 parts MgO, 56 of CaO and so on, as enunciated in Richters' second law.

It must be understood that these laws hold good only when the fluxes are enabled to exert their maximum effect. The temperature must be sufficiently elevated that they all come into full play. That is, while one may begin work at one temperature, others will require considerable higher heat before they come into action, but this latter temperature at least is necessary in order that they may produce effects in accordance with the laws of Richters and Cranier. The clay must be brought into a state of actual glassy fusion. These laws apply, then, only on the complete melting of a clay body and would not be true for the action of fluxes as clays are ordinarily burned in the kiln nor would they be any more than very generally approximately true in the vitrification of clays.

From this brief consideration of the effects of fluxes in the fusion of clays, it may be seen that the higher in clay substance a clay is, i. e. the more aluminous, the more refractory it will be. Also, in a clay with a low percentage of fluxes, additions of silica lower its refractoriness. But a clay already high in fluxes will be rendered less fusible by increasing the silica content.

EFFECT OF PHYSICAL CONDITION ON FUSIBILITY.

The two most important conditions which influence the fusibility of any composite substance are homogeneity and the character of grain. If it is a mixture, the particles of each component must be uniformly distributed so that each part of the whole will be like every other part, in order that the mass will respond best to the action of heat. It is well known that clays as found in nature are seldom homogeneous, but the constituent minerals are more or less segregated and separate from each other. In testing clays for fusibility, it is necessary to reduce them to a condition of as great homogeneity as possible.

The fineness of the constituent grains of a clay is known to influence its fusibility. If the particles are finely divided they are able to come more intimately in contact with each other, leaving smaller openings or pore spaces across which heat must be transmitted from one to another. For this reason the heat is propagated rapidly and distributed more uniformly through the heating body than when the particles are larger, hence in contact at fewer points, and have larger interstices between them. This is known to be true for all of the lower grades of clay, or those which would not be classed as fire clays. Hoffman* has shown that for fire clays (clays melting above cone 26, about 1650° C.) the character of the grain has substantially no influence on the fusibility of the clay. Aside from mere fineness, the shape and range of size of particles have a controlling influence. It is impossible for rounded grains to as completely fill in space as angular ones. A range of size is also advantageous to fusion. The smaller granules fill in, so to speak, the interstices between the larger ones, which makes the clay denser and hence a better conductor.

Physically, therefore, the finer and more angular the particles, the more favorable is the structure to fusion of the clay. A range of sizes still smaller than the maximum sized particles is also conducive to the easiest fusion of the clay.

METHODS OF EXPRESSING FUSIBILITY.

With a knowledge of the relative values of the several common fluxes in clays in influencing fusibility, investigators have undertaken to express comparative fusibilities by means of the relation of the fluxes to the refractory elements of the clay.

Bischof, a German scientist, has developed such an expression which he calls the "Feuerfestigkeits Quotient"†. It is as follows:

$$F. Q. = \frac{(\text{Oxygen in } Al_2O_3)^2}{(\text{Oxygen in RO})(\text{Oxygen in } SiO_2)}, \text{ in which}$$

* Am. Institute of Min. Eng. Vol. XXVIII, p. 440.

† Die Feuerfesten Thone. Dr. Carl Bischof, p. 116.

RO represents the sum of the fluxes, each considered as the protoxid. This will give numerical results ranging from a very small decimal to as high as 25.

It is seen according to this formula that the fusibility of clays varies directly as the square of the oxygen in the alumina and inversely as the oxygen in the silica and the fluxes. Bischof's observations led him to the conclusion that the amount of alumina in the clay practically determined its fusibility. In regard to the adequacy of this formula for expressing fusibility, Wheeler* states:

“(1) That while an increase in the percentage of alumina decreases the fusibility, when it becomes very high it acts the part of an acid instead of a base and tends to lower the fusing point instead of raising it, which is just the reverse of Bischof's formula, when this point is reached; neither does the fusibility decrease when the alumina is in moderate amounts, at the rapid rate of the square of the alumina; (2) when the silica is present in amounts greater than a mono-silicate (which is always the case with clays), the fusibility decreases as the silica increases, which is just the reverse of Bischof's formula; yet this is one of the best and most conclusively established facts in metallurgy; (3) as a broad rule, the fusibility increases as the bases increase, at least to the extent that they occur in clays; but there is a very great range in the fusibility according to the bases that are present. The alkalis are more readily fusible than the ferrous oxid, which latter is more fusible than lime, and lime more fusible than magnesia. Again a mixture of bases is more fusible than a single base, and the greater the number of bases the greater the fusibility. Bischof's formula, however, pays no attention to the bases present, or how many, though usually lime, iron, magnesia and the alkalis are present in all clays to some extent. As the above experience of the metallurgist with

* Missouri Geological Survey, Vol. XI, p. 146.

slags covers a very wide range of silicates, though they are more basic, less aluminous and less silicious than clays, it at least throws very grave doubts upon the reliability of Bischof's formula."

Again on page 148:

"The unreliability of Bischof's formula arises partly from its faulty construction, partly from the faulty weighing of the detrimental constituents, and partly from ignoring the physical factors. The latter fault is very serious, if clays differ much in density or fineness, but when these physical properties are similar, then it is possible to compare the fusibility of two clays solely from the analysis, if the proper valuations are given to the constituents."

Dr. Seger, one of Bischof's contemporaries, devised as a substitute for Bischof's formula:

$$F. Q. = \frac{(Al_2O_3)_2}{RO \times SiO_2} + \frac{Al_2O_3}{RO}$$

This has proved somewhat of an improvement over Bischof's, but neither take into account the factors porosity and fineness and character of grain. These formulae assume that the physical structure has no influence on fusibility, which is known not to be the case. They are based entirely upon chemical considerations and are of use only with clays of similar physical condition. The more nearly pure the clay is, the more accurate would these expressions be, for, as shown by Hoffman, the size of grain in refractory clays has practically no effect on their fusibility. It has been repeatedly demonstrated that these formulae furnish the least reliable information with the most impure clays.

Wheeler, in his report on the Clays of Missouri referred to above, page 149, expresses a relation between the detrimental and non-detrimental constituents of clays which he calls the fusibility factor.

$$F. F. = \frac{N}{D + D'}$$

N in this expression represents the sum of total silica, alumina, titania, water and carbonic acid. D is the total fluxes: the alkalis, iron oxid, lime and magnesia. D' represents the sum of the alkalis.

Wheeler in this formula does not discriminate between free and combined silica and assumes that silica in the free state does not act as a flux. The alkalis are added twice as they are estimated by him to have double the fluxing value of the other oxids. The formula as written above will give numerical values which represent the relative fusibility of clays that are physically alike, i. e., have the same specific gravity and fineness of grain. If clays under consideration differ in those properties, the formula is to be modified as follows:

$$F. F. = \frac{N}{D + D' + C}, \text{ C having these values:}$$

- C=1 when clay is coarse-grained and specific gravity exceeds 2.25.
- C=2 when clay is coarse-grained and specific gravity ranges from 2 to 2.25.
- C=3 when clay is coarse-grained and specific gravity ranges from 1.75 to 2.00.
- C=2 when clay is fine-grained and specific gravity is over 2.25.
- C=3 when clay is fine-grained and specific gravity is from 2 to 2.25.
- C=4 when clay is fine-grained and specific gravity is from 1.75 to 2.25.

In offering a formula of this nature, the author of it is certainly progressing in the right direction by taking into consideration the physical character of the clay. The values are not specific and it is obvious that they can not be until some accurate method of designating degrees of fineness of grain is obtained. The specific gravities given are not based on the mineral constituents of the clay alone. While they represent the specific gravity of the clay as a body consisting of mineral particles and pore spaces and may serve the purpose of use in this formula, they are not the true specific gravity of the rock which is always determined by the minerals composing it.

The foregoing are examples of the chemical methods of expressing fusibility. These are not yet sufficiently refined to be of much practical value. It is the opinion of the writers that fur-

ther development of these methods may come from study of the rational composition of clays, along with a knowledge of their mechanical composition. It is believed that mechanical analysis and the chemical determination of the mineral constitution of clays are to play a more important role in studying their behavior under heat than heretofore. From these phases of investigation, light may not only be thrown upon the action of clays in fusing but many of the phenomena of ordinary burning may be better understood.

METHODS OF MEASURING FUSIBILITY.

The means of measuring fusibility may be classified as indirect and direct. In the first, the measurement depends on determining, or estimating, the degrees of temperature required to fuse a given clay. The latter amounts to a comparison of the ability of different clays to withstand the effects of rising temperature. Of the indirect methods, those of Bischof and Hoffman will be briefly reviewed. Bischof made use of the German Saarau fire clay which fuses at Seger cone 36, or about 1850° C., as a standard of comparison. A weighed amount of the clay to be tested was then toned up with increasing quantities of a mixture of equal parts of pure silica and alumina. It was then formed into small prisms and heated with a prism of the Saarau clay. The temperature used by Bischof was slightly above that of the melting point of wrought iron. The prism of the clay thus toned up which behaved in the fire as the standard prism, was the one which furnished the index of the fusibility of the clay. That is, although neither of the clays actually fuse, their similarity of behavior gives an approximate idea of the refractory quality of the clay tested.

Bischof used this method largely for testing only very refractory clays. In testing those that are not highly refractory but still not sufficiently fusible to be readily melted in the gas fur-

nace, Hoffman* has followed the same principle of toning up with refractory ingredients but has assumed as the standard instead of the Saarau clay, Seger cone 26, fusing at 1650° C. This cone is arbitrarily employed as the dividing line between refractory or fire clays and non-refractory clays. The reason for assuming cone 26 as the standard was that such high temperatures would not be needed and that it would be of more interest and value to determine how far a non-refractory clay was below the refractory class than to find out how much negative flux would have to be added to it to bring it up to the cone 36 standard.

Instead of making into the form of prisms, Hoffman molded the toned samples into small cones or pyramids the size of the Seger cone. These were heated with cone 26 in a Deville furnace until the latter fused. The mixture of clay and flux showing the same degree of fusion as cone 26 is taken as the critical mixture and the amount of flux required is the index of fusibility.

As stated above, the direct method consists of actual measurement of the degrees of heat required to melt a given clay. This is accomplished by two fairly distinct means, viz., the pyrometer and the Seger cone.

There are several types of instrumental pyrometers on the market which are capable of giving fairly accurate results within certain limits. Among these may be mentioned the optical pyrometer, whose use depends on the analysis of the light emitted from a heated object by means of two Nicol prisms between which is a thin quartz plate; Siemen's water pyrometer, which works on the principle of the water calorimeter, the temperature of any heated space being determined by immersing a small metal cylinder, drawn from the temperature to be measured, in a vessel of water and noting the rise in temperature of the water.

* Am. Inst. Min. Eng., Vol. XXVIII, p. 435.

These, I believe, are not used to any extent in the clay industries.

The Wedgewood pyrometer which depended upon the expansion of bars of clay when heated is no longer considered sufficiently accurate and has practically gone into disuse. Pyrometers depending on the difference of coefficient of expansion of two metals are also manufactured, but they are short lived because of the susceptibility of most common metals to the attack of hot gases or liquids which corrodes them and alters their properties.

The electric pyrometer is used in many establishments manufacturing the higher grades of clay wares for controlling the heat of the kilns and it is coming into somewhat general application in all the metallurgical industries where it is necessary to control the temperature of any process. The common form of the instrument consists of a thermopile and galvanometer. Its operation depends on the measurement of the light electric current generated by heating the union of two wires of slightly different chemical composition. The metals commonly employed are platinum and rhodium, as they are non-corrosive and their fusing points are very high.

The Le Chatelier pyrometer is the best example of the electric type. It consists of a thermo-element, the wires being about four feet long, one of which is pure platinum and the other an alloy of platinum with ten per cent of rhodium. One of these is encased in a small porcelain tube so that the two are kept separate. A large porcelain tube closed at the furnace end surrounds all, thus protecting the wires completely from contact with the medium whose temperature is to be measured. A galvanometer of the D'Arsonval pattern registers the current in milli-volts and is also graduated to read degrees Centigrade. This instrument is made accurate to 1600° C. With this device a temperature curve can be drawn for each burn by recording at intervals the readings of the pyrometer. Some firms also furnish recording devices by which a continuous curve may be traced on a rotating cylinder.

Alloys of the precious metals silver, gold and platinum and, even the metals themselves all of whose melting points are known, have been made use of to some extent as indicators of temperature in different branches of the ceramic industries. They are not only extraordinarily expensive but the range of temperature which it is possible to control with them is of necessity small, hence they are not fitted for practical use in any large way.

Experimentation along this same line of producing mixtures of known fusion points led to the invention by Dr. Seger* of his pyrometric cones which have in recent years attained a wide use in all lines of clay working. These cones, or better called pyramids, or tetrahedra (for they are triangular pyramids with flat bases), are made from the raw mineral ingredients, feldspar, calcium carbonate, iron oxid, quartz and kaolin. In other words, from the same substances of which clays themselves are largely composed. The cones are small, two to two and one-half inches high and since they are very similar in composition to clays, will when heated undergo exactly the same changes. The application of these mixtures to the determination of clay burning temperatures means simply the use of a small amount of clay whose melting point is known, instead of some metal or alloy.

In composition, the cone series begins with Al_2O_3 , 1.5SiO_2 , the most refractory mixture. The cones were originally numbered from 36, which has the above composition, down to 1, with the composition $\left. \begin{array}{l} .3\text{K}_2\text{O} \\ .7\text{CaO} \end{array} \right\} \left. \begin{array}{l} .2\text{Fe}_2\text{O}_3 \\ .3\text{Al}_2\text{O}_3 \end{array} \right\} 4\text{SiO}_2$ with a gradually increasing proportion of fluxes between these limits. Some time after their invention, Dr. Cramer extended this series by adding a more fusible series and numbered them from one downward by prefixing a cipher to each number. Thus the complete series at present numbers from 36 to 1 and from 01 to 022, the last being the most fusi-

* A discussion of the development of the Seger cone series may be found in the American translation of Seger's Collected Works, Vol. 1, p. 224.

ble of all. In these more fusible mixtures of Cramer, other fluxes were necessarily employed than those mentioned above. Soda, lead oxid and boracic acid are used in these low numbers.

The complete range of temperature represented between the limits cones 36 and 022 is 1260 degrees Centigrade, from 1850 down to 590 degrees. Cone 022 melts at a visible red heat, while the highest of the series requires for fusion dazzling white heats. The difference in the melting points of any two consecutive members of the series is uniformly 20° C. from 36 to 010. Below this they run 30 instead of 20 degrees apart.

COMPOSITION AND FUSING POINTS OF SEGER CONES.

| No. of cone. | COMPOSITION. | | | FUSING POINT. | |
|--------------|-----------------------------------|------------------------------------|-----------------------|---------------|-------|
| | | | | °F | °C |
| 022 | 0.5Na ₂ O | | 2.0 SiO ₂ | 1,094 | 590 |
| | 0.5 P ₂ O ₅ | | 1.0 BO | | |
| 021 | 0.5Na ₂ O | 0.1 Al ₂ O ₃ | 2.2 SiO ₂ | 1,148 | 620 |
| | 0.5 PbO | | 1.0 BO | | |
| 020 | 0.5Na ₂ O | 0.2 Al ₂ O ₃ | 2.4 SiO ₂ | 1,202 | 650 |
| | 0.5 PbO | | 1.0 BO | | |
| 019 | 0.5Na ₂ O | 0.3 Al ₂ O ₃ | 2.6 SiO ₂ | 1,256 | 680 |
| | 0.5 PbO | | 1.0 BO | | |
| 018 | 0.5Na ₂ O | 0.4 Al ₂ O ₃ | 2.8 SiO ₂ | 1,310 | 710 |
| | 0.5 PbO | | 1.0 BO | | |
| 017 | 0.5Na ₂ O | 0.5 Al ₂ O ₃ | 3.0 SiO ₂ | 1,364 | 740 |
| | 0.5 PbO | | 1.0 BO | | |
| 016 | 0.5Na ₂ O | 0.55Al ₂ O ₃ | 3.1 SiO ₂ | 1,418 | 770 |
| | 0.5 PbO | | 1.0 BO | | |
| 015 | 0.5Na ₂ O | 0.6 Al ₂ O ₃ | 3.2 SiO ₂ | 1,472 | 800 |
| | 0.5 PbO | | 1.0 BO | | |
| 014 | 0.5Na ₂ O | 0.65Al ₂ O ₃ | 3.3 SiO ₂ | 1,526 | 830 |
| | 0.5 PbO | | 1.0 BO | | |
| 013 | 0.5Na ₂ O | 0.7 Al ₂ O | 3.4 SiO ₂ | 1,580 | 860 |
| | 0.5 PbO | | 1.0 BO | | |
| 012 | 0.5Na ₂ O | 0.75Al ₂ O ₃ | 3.5 SiO ₂ | 1,634 | 890 |
| | 0.5 PbO | | 1.0 BO | | |
| 011 | 0.5Na ₂ O | 0.8 Al ₂ O ₃ | 3.6 SiO ₂ | 1,688 | 920 |
| | 0.5 PbO | | 1.0 BO | | |
| 010 | 0.3 K ₂ O | 0.2 Fe ₂ O ₃ | 3.50 SiO ₂ | 1,742 | 950 |
| | 0.7 CaO | | 0.50 BO | | |
| 09 | 0.3 K ₂ O | 0.2 Fe ₂ O ₃ | 3.55 SiO ₂ | 1,778 | 970 |
| | 0.7 CaO | | 0.45 BO | | |
| 08 | 0.3 K ₂ O | 0.2 Fe ₂ O ₃ | 3.60 SiO ₂ | 1,814 | 990 |
| | 0.7 CaO | | 0.40 BO | | |
| 07 | 0.3 K ₂ O | 0.2 Fe ₂ O ₃ | 3.65 SiO ₂ | 1,850 | 1,010 |
| | 0.7 CaO | | 0.35 BO | | |
| 06 | 0.3 K ₂ O | 0.2 Fe ₂ O ₃ | 3.70 SiO ₂ | 1,886 | 1,030 |
| | 0.7 CaO | | 0.30 BO | | |
| 05 | 0.3 K ₂ O | 0.2 Fe ₂ O ₃ | 3.75 SiO ₂ | 1,922 | 1,050 |
| | 0.7 CaO | | 0.25 BO | | |

COMPOSITION AND FUSING POINTS OF SEGER CONES—CONTINUED.

| No. of cone. | COMPOSITION. | | | FUSING POINT | | | |
|-----------------|--------------|------------------|-------------------------------------|--------------|-------------------------------|-------|-------|
| | | | | ° F | ° C | | |
| 04 | 0.3 | K ₂ O | 0.2 Fe ₂ O ₃ | 3.80 | SiO ₂ | 1,958 | 1,070 |
| | 0.7 | CaO | 0.3 Al ₂ O ₃ | 0.20 | B ₂ O ₃ | | |
| 03 | 0.3 | K ₂ O | 0.2 Fe ₂ O ₃ | 3.85 | SiO ₂ | 1,994 | 1,090 |
| | 0.7 | CaO | 0.3 Al ₂ O ₃ | 0.15 | B ₂ O ₃ | | |
| 02 | 0.3 | K ₂ O | 0.2 Fe ₂ O ₃ | 3.90 | SiO ₂ | 2,030 | 1,110 |
| | 0.7 | CaO | 0.3 Al ₂ O ₃ | 0.10 | B ₂ O ₃ | | |
| 01 | 0.3 | K ₂ O | 0.2 Fe ₂ O ₃ | 3.95 | SiO ₂ | 2,066 | 1,130 |
| | 0.7 | CaO | 0.3 Al ₂ O ₃ | 0.05 | B ₂ O ₃ | | |
| 1 | 0.3 | K ₂ O | 0.2 Fe ₂ O ₃ | 4. | SiO ₂ | 2,102 | 1,150 |
| | 0.7 | CaO | 0.3 Al ₂ O ₃ | | | | |
| 2 | 0.3 | K ₂ O | 0.1 Fe ₂ O ₃ | 4. | SiO ₂ | 2,138 | 1,170 |
| | 0.7 | CaO | 0.4 Al ₂ O ₃ | | | | |
| 3 | 0.3 | K ₂ O | 0.05 Fe ₂ O ₃ | 4. | SiO ₂ | 2,174 | 1,190 |
| | 0.7 | CaO | 0.45 Al ₂ O ₃ | | | | |
| 4 | 0.3 | K ₂ O | 0.5 Al ₂ O ₃ | 4. | SiO ₂ | 2,210 | 1,210 |
| | 0.7 | CaO | | | | | |
| 5 | 0.3 | K ₂ O | 0.5 Al ₂ O ₃ | 5. | SiO ₂ | 2,246 | 1,230 |
| | 0.7 | CaO | | | | | |
| 6 | 0.3 | K ₂ O | 0.6 Al ₂ O ₃ | 6. | SiO ₂ | 2,282 | 1,250 |
| | 0.7 | CaO | | | | | |
| 7 | 0.3 | K ₂ O | 0.7 Al ₂ O ₃ | 7. | SiO ₂ | 2,318 | 1,270 |
| | 0.7 | CaO | | | | | |
| 8 | 0.3 | K ₂ O | 0.8 Al ₂ O ₃ | 8. | SiO ₂ | 2,354 | 1,290 |
| | 0.7 | CaO | | | | | |
| 9 | 0.3 | K ₂ O | 0.9 Al ₂ O ₃ | 9. | SiO ₂ | 2,390 | 1,310 |
| | 0.7 | CaO | | | | | |
| 10 | 0.3 | K ₂ O | 1.0 Al ₂ O ₃ | 10. | SiO ₂ | 2,426 | 1,330 |
| | 0.7 | CaO | | | | | |
| 11 | 0.3 | K ₂ O | 1.2 Al ₂ O ₃ | 12. | SiO ₂ | 2,462 | 1,350 |
| | 0.7 | CaO | | | | | |
| 12 | 0.3 | K ₂ O | 1.4 Al ₂ O ₃ | 14. | SiO ₂ | 2,498 | 1,370 |
| | 0.7 | CaO | | | | | |
| 13 | 0.3 | K ₂ O | 1.6 Al ₂ O ₃ | 16. | SiO ₂ | 2,534 | 1,390 |
| | 0.7 | CaO | | | | | |
| 14 | 0.3 | K ₂ O | 1.8 Al ₂ O ₃ | 18. | SiO ₂ | 2,570 | 1,410 |
| | 0.7 | CaO | | | | | |
| 15 | 0.3 | K ₂ O | 2.1 Al ₂ O ₃ | 21. | SiO ₂ | 2,606 | 1,430 |
| | 0.7 | CaO | | | | | |
| 16 | 0.3 | K ₂ O | 2.4 Al ₂ O ₃ | 24. | SiO ₂ | 2,642 | 1,450 |
| | 0.7 | CaO | | | | | |
| 17 | 0.3 | K ₂ O | 2.7 Al ₂ O ₃ | 27. | SiO ₂ | 2,678 | 1,470 |
| | 0.7 | CaO | | | | | |
| 18 | 0.3 | K ₂ O | 3.1 Al ₂ O ₃ | 31. | SiO ₂ | 2,714 | 1,490 |
| | 0.7 | CaO | | | | | |
| 19 | 0.3 | K ₂ O | 3.5 Al ₂ O ₃ | 35. | SiO ₂ | 2,750 | 1,510 |
| | 0.7 | CaO | | | | | |
| 20 | 0.3 | K ₂ O | 3.9 Al ₂ O ₃ | 39. | SiO ₂ | 2,786 | 1,530 |
| | 0.7 | CaO | | | | | |
| 21 | 0.3 | K ₂ O | 4.4 Al ₂ O ₃ | 44. | SiO ₂ | 2,822 | 1,550 |
| | 0.7 | CaO | | | | | |
| 22 | 0.3 | K ₂ O | 4.9 Al ₂ O ₃ | 49. | SiO ₂ | 2,852 | 1,570 |
| | 0.7 | CaO | | | | | |
| 23 | 0.3 | K ₂ O | 5.4 Al ₂ O ₃ | 54. | SiO ₂ | 2,894 | 1,590 |
| | 0.7 | CaO | | | | | |
| 24 | 0.3 | K ₂ O | 6.0 Al ₂ O ₃ | 60. | SiO ₂ | 2,930 | 1,610 |
| | 0.7 | CaO | | | | | |

COMPOSITION AND FUSING POINTS OF SEGER CONES—CONTINUED.

| No. of cone. | COMPOSITION. | | | | FUSING POINT. | |
|-----------------|---------------------------------|------------------------------------|-----|------------------|---------------|-------|
| | | | | | ° F | ° C |
| 25 | 0.3 K ₂ O 0.7 CaO | 6.6 Al ₂ O ₃ | 66. | SiO ₂ | 2,966 | 1,630 |
| 26 | 0.3 K ₂ O 0.7 CaO | 7.2 Al ₂ O ₃ | 72. | SiO ₂ | 3,002 | 1,650 |
| 27 | 0.3 K ₂ O 0.7 CaO | 2.0 Al ₂ O ₃ | 200 | SiO ₂ | 3,038 | 1,670 |
| 28 | | Al ₂ O ₃ | 10 | SiO ₂ | 3,074 | 1,690 |
| 29 | | Al ₂ O ₃ | 8 | SiO ₂ | 3,110 | 1,710 |
| 30 | | Al ₂ O ₃ | 6 | SiO ₂ | 3,146 | 1,730 |
| 31 | | Al ₂ O ₃ | 5 | SiO ₂ | 3,182 | 1,750 |
| 32 | | Al ₂ O ₃ | 4 | SiO ₂ | 3,218 | 1,770 |
| 33 | | Al ₂ O ₃ | 3 | SiO ₂ | 3,254 | 1,790 |
| 34 | | Al ₂ O ₃ | 2.5 | SiO ₂ | 3,290 | 1,810 |
| 35 | | Al ₂ O ₃ | 2 | SiO ₂ | 3,326 | 1,830 |
| 36 | | Al ₂ O ₃ | 1.5 | SiO ₂ | 3,322 | 1,850 |

In practice, the cones are mounted upright on a small block of clay and placed in the kiln or furnace where they will be surrounded by as nearly the average temperature as possible. An advantageous method is to so locate them that they may be observed from the outside. It is first ascertained to the melting point of which cone the ware is to be burned. Then a number of the more readily fusible than the critical one are usually put in so that the fusion of the lower ones gives warning of the approach to the required temperature. As the melting point of a cone is neared, it gradually softens and the top bends over. When the tip of the cone just touches the base, its fusion point is considered reached. It is not customary for the users of these cones, nor indeed is it at all necessary, to determine temperatures in degrees of any thermometer scale. What they wish to determine is the finishing heat for the ware they are burning. When a certain cone melts they know that a certain amount of work has been accomplished by the heat and that it is time to close down. They become accustomed to burning off at cone 02 or cone 1 rather than 1110 or 1150 degrees Centigrade.

Following this brief discussion of some of the principles upon which the fusion of clay depends and of the methods of express-

ing and measuring fusibility, it is the object of this work to present the methods employed and the results obtained in experimenting to determine the fusibility of some of Iowa's clays.

METHOD OF PREPARING THE CLAY FOR FUSION TESTS.

The clay was first ground to pass a forty-mesh sieve. A small amount was then mixed with water to its best plasticity and spread out on a glass plate by means of a small trowel or spatula to a thickness of about one-fourth of an inch. From this were cut small strips, approximately three and one-half inches in length and tapering from three-eighths of an inch in width at one end to one-eighth at the other.

These were allowed to dry and then mounted by setting the narrow end into the upper end of a block of soft fire clay. This block of fire clay shaped with a trowel is two and three-fourths to three inches high, about an inch and a quarter square at the base and slightly narrowing upwards. The strip of clay to be tested was so cemented into the plastic fire clay that it maintained an upward sloping position from its support of 15° to 20° from the horizontal. The heavier end being thus unsupported and somewhat above the other, will gradually lower as the clay softens. While still soft, the fire clay was perforated near the center so it could be removed from the furnace by means of a bent metal rod.

After the fire clay bases were dry they were placed in a Hoskins No. 4 muffle furnace in positions such that they could be observed through a peep hole in the muffle door. In order to note the change suffered by the clays during successive stages of the burn, a series of six samples of each clay was prepared in the above manner and only one clay could be tested at a time. The first sample was drawn at 600° , a second at 800° , a third at 1000° , a fourth at 1100° and so on until the clay was melted.

On actual trials with paving, common and pressed brick clays by the method above outlined, they were found to act in general

as was expected. Changes in color, porosity, etc., took place as the temperature was raised, just as in ordinary kiln burning, until vitrification temperatures were attained. As the clay softened, the weight of the outer, heavier and unsupported end of the clay strip caused bending downward of the latter close to the fire clay support. The indication of the pyrometer was carefully noted when the clay first began to bend as also when it was clear down.

In some of the weaker, less coherent samples, trouble was encountered by the strip breaking just before reaching the vitrifying point. This was the case with some of the loess clays and very arenaceous and indurated shales. After undergoing dehydration and oxidation, the clays appeared to be weaker than when raw—enough so that they were no longer able to maintain the rigidity which they possessed dry. This was further evidenced by the results of the tensile strength tests of the raw and burned clay.

In making fusion tests of clays, there are two principal points which it is desirable to determine. It is interesting from the scientific standpoint alone to ascertain just how much heat is required to melt a clay, i. e., to reduce it to a state of actual fusion. Secondly, it is not only of interest from the scientific viewpoint but much more so from the practical standpoint, to determine where a clay begins to soften or vitrify and what the range is between this incipient vitrification and the condition where it would be too soft to bear any weight without distortion. The latter condition is not yet one of fusion but one only of thorough vitrification. A knowledge of the interval between beginning vitrification and the stage where the clay will no longer retain its shape is very important and even indispensable to the manufacturer of vitrified ware. It is of no use to him to know how much more heat would be necessary to actually fuse the clay, for the state of complete vitrification is the limit so far as the making of a salable product is concerned.

In the present experiments, no attempt was made to bring the clays to a state of fusion. This was unnecessary in order to give the results their greatest value in a practical way. The clays were heated until the small bars began to bend and this point was considered incipient vitrification as defined by Wheeler. The increment of temperature possible between this and the attainment of the vertically hanging position of the strips was considered the allowable range in kiln practice. This last stage is, obviously, with most clays much different from actual fusion, which may still require a few hundred degrees increase of temperature. It is a condition, however, in which the clay is becoming viscous and will no longer hold its shape under the action of any outside deforming force. This would be the condition which pavers reach in the bottom of a large kiln when they come out "kiln marked" or indented by the bricks above them.

These tests were made in a Hoskins muffle furnace No. 4. The chamber has inside dimensions approximately 8 by 14 by 5 inches. The fuel is gasoline supplied to two burners from a six-gallon cylindrical tank. An air pump is attached to the tank so that any pressure below fifty pounds per inch may be maintained on the burners. (See figure 3.)

Temperatures were measured by the LeChatelier pyrometer, checked quite frequently with Seger cones. There was sometimes found a considerable disparity between the two, as much as 100 or 125 degrees C., then again they would check within a reasonably small margin. This variation could sometimes be accounted for by the difference in temperature in different parts of the muffle. Even in such a small chamber as this there is often a difference of 100° in the space of several inches. The readings of the LeChatelier instrument were substantially relied on throughout the tests. A temperature curve was drawn from the pyrometer readings with every burn. A reading was recorded every ten minutes. The abscissal distance was thus divided into

ten minute spaces and each ordinate division represented 30 degrees Centigrade. The clays required from three to six hours for each burn, depending upon the refractoriness of the one under trial.

The subjoined table is made to show the temperature data obtained.

| CLAYS. | Temperature of Vitrification ° C. | |
|--|-----------------------------------|-------------------|
| | Incipient. | Complete. |
| Flint Brick Co., bottom..... | 1150 | 1200 |
| Flint Brick Co., middle | 1200 | 1300 |
| Flint Brick Co., top | 1340 | ?? |
| Flint Brick Co., green brick | 1130 | 1260 |
| Capital City Brick and Pipe Co., top | 1060 | 1175 |
| Capital City Brick and Pipe Co., 2nd..... | 1110 | 1250 |
| Capital City Brick and Pipe Co., 3rd..... | Unvitrified at | 1300 |
| Capital City Brick and Pipe Co., 4th..... | 1115 | 1300+ |
| Capital City Brick and Pipe Co., bottom | 1110 | 1260 |
| Capital City Brick and Pipe Co., green brick | 1140 | 1250 |
| Iowa Brick Co., bottom..... | 1100 | 1235 |
| Iowa Brick Co., 2nd | 1100 | 1225 |
| Iowa Brick Co., 3rd..... | 1300 | ?? |
| Iowa Brick Co., 4th | 1100 | 1250 |
| Iowa Brick Co., 5th | 1170 | 1230 |
| Iowa Brick Co., top | Unaffected at | 1325 |
| Granite Brick Co., top..... | 1045 | 1130 |
| Granite Brick Co., bottom | 1065 | 1110 |
| Dale Brick Co., shale..... | 1090 | 1200+ |
| Corey Brick Co., red | 1175 | 1225? |
| Corey Brick Co., buff | 1200 | 1300+ |
| L. M. Harris, white burning | 1100 | 1130 [±] |
| Clermont Brick and Tile Co., white burning | Unvitrified at | 1300 |
| Storm Lake Brick and Tile Co., drift clay..... | ?? | 1150 [±] |
| American Brick and Tile Co., plastic shale.... | 900 | 1060 |
| B. B. Jester bank, white burning..... | Unaffected at | 1350 |
| Colesburg, potter's clay..... | 1120 | 1200 [±] |
| L. C. Besley, loess top..... | 950 | 1030 |
| L. C. Besley, middle loess..... | 990 | 1075 |
| L. C. Besley, bottom loess..... | 1010 | 1115 |
| Dale Brick Co., top loess..... | 1020 | 1125 |
| Gethmann Brick Co., loess | 940 | 1000 |

The first eighteen members of the table are clays used in the paving brick industry. The following three are used in the man-

ufacture of dry press brick. The two white burning clays, that of Mr. Harris and of the Clermont Brick and Tile Company, are employed in making building brick by the stiff mud process. The Storm Lake Brick and Tile Company use a wash from the Wisconsin drift for making common brick and drain tile. The American Brick and Tile Company make an excellent grade of hollow brick and block besides common brick and drain tile. The white burning clay from the Jester bank near Danville, Iowa, is not at present utilized. The Colesburg potter's clay has been made use of in the manufacture of the commoner pieces of stoneware for which it was found quite suitable, but its use is now limited to flower pot manufacture. The Besley clays are used for common brick made by the soft mud process, while the last two clays listed in the table are employed in making dry press brick.

CHAPTER IV.

Processes in the Manufacture of Clay Wares.

WINNING OF THE RAW MATERIAL.

In the manufacture of any products making use of raw materials found in nature, the first problem to be met is that of winning. Winning includes that preliminary part of the process of manufacture which brings the crude materials to the preparing machinery. In the clay industries, different methods are employed which are determined principally by, first, location of the clay deposit with reference to the plant; second, stratigraphic position of the desired clay strata; third, character of the clay itself; fourth, attitude of the strata in the bank.

It is always advantageous to build the manufacturing plant as close as possible to the deposit of raw material. When it can be located in immediate proximity to the bank and at the same time have good facilities for conveying the products from the

factory to the markets, no other location should be considered. The expense of conveyance from pit to works is low and where railroad transportation of the finished product is had, the cost of any short extension of the necessary branch to the main line will not in the long run be considerable. If the ware is transported by team haulage, an extra few miles' drive makes little difference; it is the handling, loading and unloading that is the expensive part of this operation, and just as much of this is required with short as with long hauls.

Conditions are frequently such that a plant must be situated at a considerably higher level than the clay to be used, and oftentimes at some distance laterally. Such a relative location of clay and plant is economical only when it comes to a question of lifting the raw clay or the finished product to a level where railroad shipment is possible. Were the plant placed on the level of or below the pit in this instance and in such a position that switches could not be extended to it for loading direct into cars, elevation of the marketable ware would be necessary, which again would involve all the expense and inconvenience of handling the ware an excessive number of times. Where team haulage and double handling are not to be avoided, there are advantages in placing the factory below the level of the strata of clay to be utilized. The clay may thus be transferred to the works largely by gravity, whether wheeled, carted or carried, a large factor that should be considered throughout the manufacturing process. Even under these conditions, however, the location ought to be chosen with discretion, looking to the lay of the land, water supply, drainage, etc.

In the exploitation of clay deposits, desirable strata are found in varying positions with reference to the surface of the country. They may be at the surface, as deposits of alluvial and glacial clays are found. Clays and shales are very commonly taken from a bank which is overlain with a layer of boulder clay of greater

or less thickness and which on account of its limy, bowldery character is undesirable in the clay mixture and must be removed. Besides glacial material alone, clays are often buried beneath strata of other undesirable argillaceous materials and sometimes limestones or sandstones cover the deposit. In this case, the ordinary operations of quarry stripping must be carried out to expose the clay stratum that is to be worked. Should the clay be found to possess exceptional qualities for some special line of manufacture or to be of a superior grade in some way especially desirable in any class of work, it may be mined where the vein is thin and the overlying strata relatively thick.

With clays in a loose state of aggregation, as alluvium and loess and most clays of recent origin, no greater force is necessary to loosen them up than that brought to bear with the plow, shovel and scraper. Some of the more compact varieties require the use of the pick and even blasting will be found necessary. Many of the shales are more or less indurated and possess a shelly, hardened structure so that blasting and picking are continually resorted to in reducing them to ponderable masses.

The attitude of the strata in a clay bank has much to do with the work which is required in removing the clay for use. As with other geological strata, beds of shale may often occupy other than horizontal positions. They may dip in one direction or another, but such inclination is usually at so low an angle as to make the dip an unimportant factor in working. Thin layers of limestone or sandstone or bands of coaly or carbonaceous matter are sometimes intercalated at varying intervals in clay beds. These may extend indefinitely or, in lens like masses feather out in a short distance. At any rate they are obstacles to successfully winning the clay and as they can not ordinarily be used in the mixture, must be gotten rid of.

The common means by which clays are won are: surface digging, quarrying and mining.

Surface Digging: Clays of the more earthy, loose-textured varieties occurring at the surface of the ground may be dug in shallow pits. Discrimination between surface digging and the second division, quarrying, may be made by placing the dividing line where the clay pit is worked as a "bank" and where blasting is necessary.

Surface digging is carried out by the use of (1) the shovel and wheelbarrow. This is of necessity the slowest mode of operation and the most expensive. It is not feasible on any large plan or where the clay must be transported for any distance to reach the plant. A second method is by the plow and scraper. By these means, more extensive operations may be carried on than with shovel and wheelbarrow and the clay may be hauled economically some distance to the preparing machinery or to the terminus of the connecting line of transportation from pit to works. With otherwise favorable conditions, a haul of five or six hundred feet is perhaps the limit.

In surface workings it is difficult to employ a method which will answer under all changes of weather, even during the working season. The materials are commonly of such a nature that heavy rains may permeate the strata worked to a greater or less extent and even fill the pit with water. Any means of working in an open pit must, therefore, be a fair weather method. Of the two mentioned above, the shovel and wheelbarrow method would be more closely controlled by the weather than the plow and scraper.

The use of the steam shovel for open surface workings is prevalent in some of the larger clay-working centers of the country. This machine could be used only where the material is of a fairly friable nature and the output large. It has been successfully operated in clay banks with open faces as high as twenty feet, and is employed where the excavation or elevation of large amounts of any earthy material is to be executed. In clay pits

where, as is usually the case, there is a vertical variation in the character of the strata, the use of the steam shovel is advantageous in averaging and maintaining more nearly constant in composition the supply of raw material. The initial outlay for the steam shovel, of course, bars its use in all small plants.

Quarrying.—Quarry methods are resorted to in digging clays where the latter are of such a character or the strata of such a thickness as to require more forcible means in loosening them up than the pick, shovel and plow. The shales, which furnish a large proportion of the raw material utilized in the clay industries, where unweathered, are usually more or less indurated. This induration has often proceeded to such an extent that the deposit takes on a slaty or stony hardness and can be broken up only by drilling and blasting. It is to this class of clays principally that quarry methods are applied.

The best quarry practice requires that where faces over twenty feet in height are to be worked, the work is best carried on by a series of benches, one above another after the fashion of the steps of a stair. For instance, instead of taking down vertically a thirty-foot bank, experience has taught that most quarry rock can be more advantageously removed by establishing an intermediate bench and working two low faces of fifteen feet each. The principal difficulty encountered in operating a quarry in benches is that of getting the rock from the upper benches to the means of transportation from the quarry. In thoroughly indurated rock like limestone and sandstone, this question is less serious than in a shale quarry. By blasting, shales are shattered into fragments of various sizes all more or less incoherent and which must be further broken up so that it may be handled with the shovel before leaving the pit. The difficulty of handling this partially comminuted clay in a quarry or several benches is evident where car lines can not be run at the different levels. This principle of quarry practice is not usually followed out in the development

of clay banks. High banks are either taken down as a whole or only comparatively low exposures are worked at a time. Each working face should be of such a height that it can be loosened from top to bottom with the common sized charge of explosive. It is customary to pick under the face of the bank as far as possible, then by means of a series of charges placed in drill holes arranged parallel to and a few feet back from the quarry face and set off simultaneously, break down and shatter large bodies of the clay. The quantity loosened with one blast depends largely upon the character of the clay itself and the type of explosive used. Black blasting powder and dynamite are in common use. They are somewhat different in their action. The explosion of black powder is due to a process of combustion, while that of dynamite is the result of a molecular rearrangement in the chemical structure of the explosive. In use, dynamite is less efficient as a lifting force than powder, so they are frequently used in conjunction, the one for opening up the bottom of a drill hole thus providing space for the charge of powder, the explosion of which becomes the real shattering force.

By a series of charges set according to the arrangement above outlined, immense bodies of clay can be broken down, if for a small plant, sufficient to run for a large part of the season. In such loosened condition, weathering progresses more effectively and the clay is in better shape when brought to the preparing machinery. In some clays, and particularly those of a fossiliferous nature, as shales and some fire clays, the matter of weathering is of prime importance. These clays have been brought to their hard and stony condition through the action of geologic forces which have compacted and modified them largely from their original purely sedimentary character. They have been subjected to the effects of changes in temperature and pressure consequent upon elevation from their place of origin on the sea bottom. Their structure and mineral constituents have been more

or less altered through solution, replacement and infiltration by percolating waters after assuming their positions above sea level. The action of the surface weathering agents, atmospheric and aqueous, is to break down the indurated structure. This it accomplishes in a mechanical way by a process of slaking, similar to the visible change that occurs when water is added to caustic lime, which gradually crumbles the clay into fine particles. More important, however, are the chemical effects of the weathering agents. The chemical processes are essentially oxidation and solution. Some of the mineral constituents of clays, as the alkalies, some iron, and lime salts, are soluble in water. In weathering these are dissolved out. Many substances which were not originally soluble, are rendered so when subjected to weathering influences through chemical changes due largely to oxidation and hydration. In unmodified shales, the iron compounds are largely in the ferrous state. Iron carbonate in weathering loses carbonic acid and is oxidized to ferric oxid which to a large extent gives to weathered clays their yellow or reddish appearance. FeS_2 exposed to air and water becomes the sulfate, melanterite, FeSO_4 , a soluble salt. CaCO_3 in the presence of sulfates may be largely changed to the sulfate and carried out in solution. Substances already soluble are removed. Minerals are oxidized and hydrated, some becoming soluble, others rendered insoluble. Whatever the change, it is from a less to a more stable compound under the prevailing conditions. The benefits of weathering are apparent. To be fully carried out, this process should be allowed to go on until all the oxidizable constituents are changed and until all the soluble ingredients are removed. This is usually accompanied by a change in the physical character of the clay which develops its property of plasticity.

It is due to the presence of soluble salts in the clay that efflorescences arise. A thoroughly weathered clay, therefore, would show no efflorescence. Clays containing ferrous iron compounds

are much more subject to trouble in burning than clays free from these. Burning in itself is largely a process of oxidation and the more fully this part of the operation can be accomplished before the kiln is reached, the less the danger of difficulty in the kiln. Similarly the less soluble lime compounds, percentages of which usually accompany the clay to the kiln, will be less obnoxious if oxidation has proceeded to the full limit.

To carry out weathering on an extensive plan would require large masses of clay to be broken down and allowed to remain exposed to the action of rains, frost and temperature changes until completely leached. Necessarily a larger quarry face would have to be kept open than where the clay is conveyed directly to the plant, but the superiority in the working quality of the clay and the improved character of the resulting ware will often justify the extra outlay in this direction. A plan followed in some instances is to provide large sheds under which the clay is piled. Under these sheds the clay is kept soaked as it is heaped up layer after layer. It is occasionally wet down while allowed to stand until needed. The effects of such treatment are similar to the outdoor process except as nature is aided and its action accelerated by man in providing a constant supply of water, which is the most important element in weathering.

Mining.—The third method of winning clay is employed only where the clay to be won is of such a nature as to be especially desirable for some line of manufacture and where clay which will serve the same purpose is not obtainable at the surface. The supply of clay in the world is so large and widespread that no deposit need be opened up unless the location and environment are favorable. In like manner in winning, no method need be employed which will not furnish the raw material, and ultimately the finished ware, to the market as cheaply as it can be done at any place in the given region. Mining is practiced in the clay industry only to a limited extent. It is more expensive than any other

method of clay getting because of the extra equipment necessary in the way of timber and extensive track lines, and provisions for ventilation, light, etc.

Mining a vein of clay would be carried on according to the same principles followed in mining coal. Two systems are in common use: the so-called room and entry or pillar plan, and the long wall system. The former is used where the veins are thick and much timbering is required. The long wall system is employed with comparatively thin veins and where the overlying material is of such a character as to furnish a fairly stable roof.

In Iowa there are but few places where clay is mined. With the exception of the Fort Dodge pottery mine, the mining of clay is carried on only in connection with the mining of coal. The clay accompanies the coal vein in the usual relation of a fire clay stratum and is taken out along with the coal itself.

Following the winning of the clay, or its removal from the bank, the different stages of the process of manufacture are as follows: transportation to works, preparation for molding, formation of the ware, drying, burning. These different operations vary in importance with the process of manufacture and the character of the clay used. For instance, in making common brick from a soft alluvial material, the processes of grinding and mixing would be less important than in the utilization of a hard shale. Likewise, with wares made by the dry press method the matter of drying requires little consideration. Brief discussion will be given to the different phases of clay working operations and their importance noted in relation to the process of manufacture employed.

TRANSPORTATION OF THE RAW MATERIAL TO THE WORKS.

This is accomplished in several ways, depending upon the amount of clay required and the location of the plant with respect to the clay deposit. Where the slope is low and the distance short,

the clay may be wheeled from the pit in barrows and dumped close to the preparing machinery. For distances over a few rods, it is seldom economical to handle clay in this way. The actual amount of clay a man can dig is greatly reduced by his having to wheel it for even a few yards. With alluvial and glacial clays that can be worked by the shovel and plow, transportation may be effected by means of wheeled scrapers. The clay is scraped up and down directly to the plant. Large quantities of clay can be economically

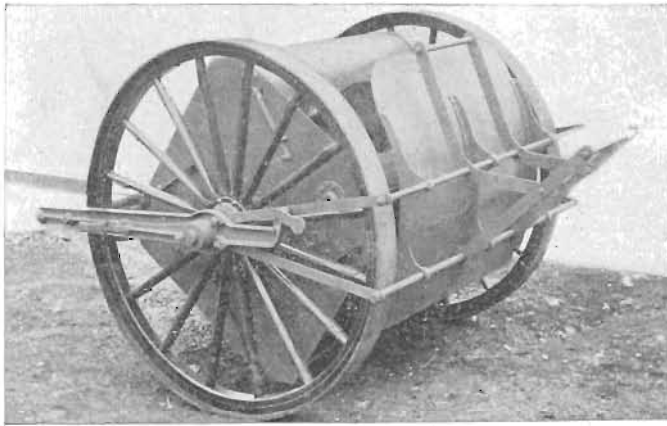

FIG. 4. Automatic Clay Gatherer, adapted to yards using Surface Clays.

removed and carried some distance in scrapers, as only one handling is required from bank to plant. The principal drawback to the more extended use of this method is that only soft materials can be handled satisfactorily. It can be used only where the clay is taken from a shallow surface stratum, and not where it is worked as a bank. In some instances, where it is impossible to locate the plant close to the clay deposit, the clay is hauled in wagons to the works. This would be feasible if the clay possessed some quality rendering it desirable for a certain class of goods, or where the operations of a plant are not extensive. Clays are frequently shipped in by rail from distant points, either to be used in mixture with a deposit near the plant or as

the entire source of supply. In any instance, this system of transportation would scarcely be advantageous unless the class of ware made was of an exclusive character, or conditions of manufacture such that all competitors were placed on an equal basis in this regard.

Horse and cart haulage is quite common. The clay after being blasted and picked loose, is loaded onto two-wheeled carts, each drawn by one horse. A most favorable condition to this class of haulage would be the existence of a low slope towards the works. On the level it will work very well, even though the distance be considerable. After a few days' employment the movements of the horses will need little attention. The animals simply follow the accustomed roadways, and after the cart is dumped at the plant, return unaccompanied to the bank. The excellence of this method over the wheelbarrow and the scraper lies in its application to all classes of clays and in the saving of the labor of one man for each cart while it is being hauled to the works and back. Where a driver is required, a small boy is often employed for this work. Of course, with a high slope either towards or from the works, it would not be advisable to use this as the best means of conveyance.

Transportation over car lines is practiced in nearly all of the larger plants. This is the most economical of any plan when large amounts of clay are needed and where the gradient to or from the plant is high. With a slope towards the works the clay may be hauled largely by gravity and the tracks so arranged that an empty car will be drawn up to the bank by the descent of the loaded car to the works. This method would necessitate a double line of track for somewhat over half the hauling distance and a revolving drum at the upper end of the line. To each end of the cable, which passes round the drum a few times so as not to allow slipping, a car is attached, so that one end of the cable is payed out as the other winds up. To effect an

arrangement of this sort the weight of the cars and the size of the loads would have to be adapted to the gradient of the roadbed.

A more common location for the plant, however, is above the level of the base of the clay deposit, and the clay must be elevated to the machines. Among numerous plants this elevation varies from the level to sixty or eighty feet. With the exception of clay raised from mines, lifting the clay is quite universally accomplished by the use of tramways, the cars being drawn up by the application of steam or horse power. Horse cars are employed to some extent where the gradient is low and the distance not great. But steam power transmitted from the power plant of the factory secondarily by means of cables is the common agent. The cars are drawn up by the cable which winds round a drum located at the works end of the line. Power is quite commonly supplied to the drum, which is thrown in or out of motion by the use of some style of clutch arrangement, directly from the main shafting of the factory. When not run in this manner the drum is actuated by a small auxiliary engine supplied with steam from the main boilers. Whether one or the other is best in a given case depends essentially upon the elevation and slope of the track and the size of car used or, in other words, the amount of power required to do the work. If considerable power is necessary and the capacity of the plant fairly large, it is usually advisable to install a small engine of the required horse power to run the hoisting drum. No matter if the slope be long and low, or short and high, it is possible to elevate the clay materials in this way. Although, where the gradient angle is high and the distance considerable, the aerial or overhead tram or ropeway might be economically employed. So far as known, this system is not in practice in the state, but there appear no valid reasons why it should not prove efficient for this purpose. Its construction is not excessively expensive, it is up and out of the way of obstructions and where made use of in other

industries it has been shown to be even less expensive to keep in repair and to operate than the average rail-track system.

The cars used in this connection are of three principal types, viz., side, bottom and end dump. Any of these may be had of varying capacity carrying from one up to two or three cubic yards of clay. Whether one style of car or another is used depends on the arrangements for dumping; and, if a large or a small car, on the amount of clay required and the height to which it is to be raised. For a plant of an average capacity, say 40,000 brick per day, from fifty to sixty-five cubic yards of clay will be needed. With cars each carrying a yard and a half of clay, to

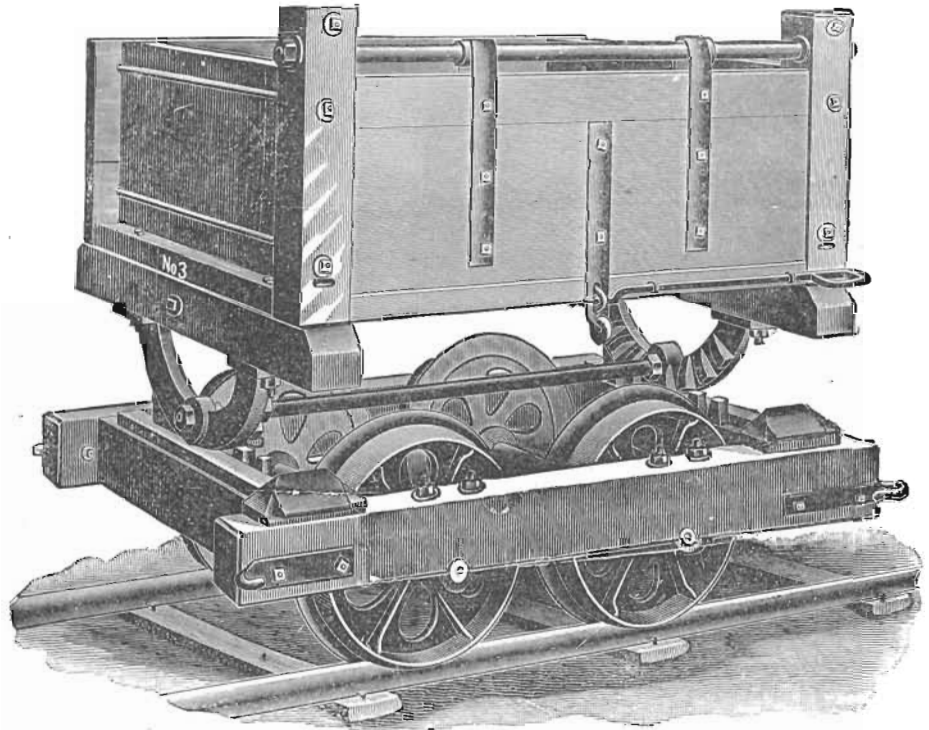

FIG. 5. Side-dumping Clay Car.

supply this output would take thirty-five or forty cars per day. Or, in a working day of ten hours, three to four cars per hour. In an ordinary shale pit this would require the work

of eight to ten men and could easily be handled by two cars. Instead of merely meeting the demand for clay as it is needed at the preparing machinery provision is usually made for a reserve supply. Sometimes sheds are provided under which the clay is accumulated in excess of what is needed for immediate manufacture. This supply may be drawn upon in periods of inclement weather or when for any reason whatever clay is not brought direct from the bank. The supply shed is usually so located as to bring the clay as near as possible to the machinery in order to reduce the expense of extra handling to the minimum. The common plan is to elevate the car track somewhat above the level of the grinding apparatus

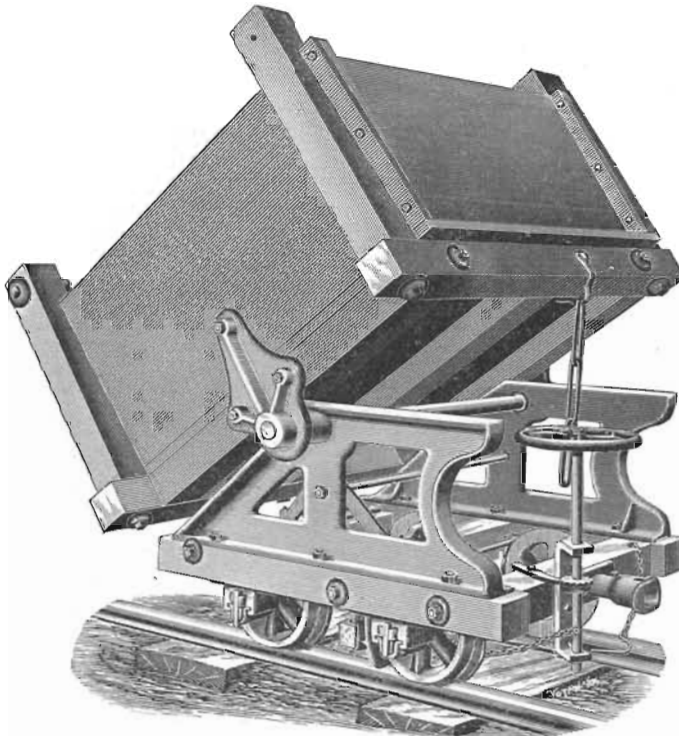

FIG. 6. End-dumping Clay Car.

and dump the raw clay on a platform or into a bin so that it may be fed, largely by gravity, to the machine. Side-dump cars would

be convenient in dumping the clay off either side of the elevated track where it is desired to store up a supply ahead of the machines. These cars may also be used in emptying to either side on a platform when found necessary. An excellent arrangement is a funnel shaped bin opening below directly into the dry pan and surrounded above by a substantial platform. The cars are run in over this bin and the clay emptied into it. When filled, further supply may be placed on the adjacent platforms. The clay is then fed entirely by gravity to the pan by the regulation of a slide at the bottom of the bin. In this case, bottom or end-dump cars would be most advantageous. In most modern car systems means are furnished for automatically dumping the clay when the cars reach a certain point in their course. The device consists of a projection or catch attached to the track which unlocks the doors of the car as it is tilted to the side or end.

Whatever the system of transportation made use of, delivery of the clay somewhat above the preparing machinery is always advisable. If drawn in on cars, it can be conveniently carried to a bin above the dry pan, as previously outlined. Brought in by horses and carts, even though hauled up a slope, it can better be elevated a few feet higher while on the cart than be dumped in such a position that a lift of one foot or more is necessary to put the clay into the machine. Arrangements can usually be made for delivering the clay onto an elevated platform from which one man can feed it into the machine. With a slight slope of the platform toward the preparing apparatus, feeding is much facilitated. If brought from the pit by wheeling in barrows, or by the use of scrapers, the same principles can well be borne in mind. Wherever horse or steam power can replace man-labor a saving is realized. It is less expensive to elevate the raw clay higher to begin with, by whatever means is used to bring the clay from the pit, than to elevate it only part way, as

is sometimes done, where it must be re-handled to lift it to the preparing machinery. A saving of labor is thus accomplished by transferring the clay in such a manner that gravity may be taken advantage of in doing the work.

PREPARATION OF THE RAW MATERIAL.

The condition of the clay as it comes from the pit is not ordinarily such that it can at once be formed into ware. If it is a hard shale clay, it will require grinding and a thorough mixing with water. If a surface clay, grinding is less important but complete mixing is necessary. Reduction to fine particles is not the only object in pulverizing a clay. Clay banks seldom consist of material constant in character from top to bottom. By grinding and mixing, an average of the bank is accomplished. The more the clay is worked with before it is molded into ware, the more perfect this mixture becomes. It is essential that the composition of the finished product be as nearly constant as possible. The burner will encounter fewer difficulties in obtaining the best results if he is unhampered by the necessity of continually adapting his firing to a clay ware of varying composition. In order to attain a uniform composition, which is always desirable, it is not only essential that the different kinds of clay be added in certain proportions, but that the mixture be uniform in all parts of the same piece of ware. This can only be brought about by pulverization of the clay. This reduction of the raw materials to a degree of fineness which experience has shown best for the class of goods to which they are applied, and blending or mixing these constituents into a homogeneous body, is accomplished by two typical methods, the dry and the wet.

DRY METHODS OF PREPARATION.

Crushers.—The first step in the preparation of clay in the dry way is reduction to fine size. For this purpose, the common rock crusher of the Blake type is an example of the apparatus

used. The machine consists of two jaws, one of which is stationary and the other mounted to work on a pivot. The faces of these two jaws are set at an angle sloping towards each other at the bottom, thus forming a V-shaped hopper. The movable part is actuated by a low eccentric by the revolution of which the hopper is alternately narrowed and broadened above and the

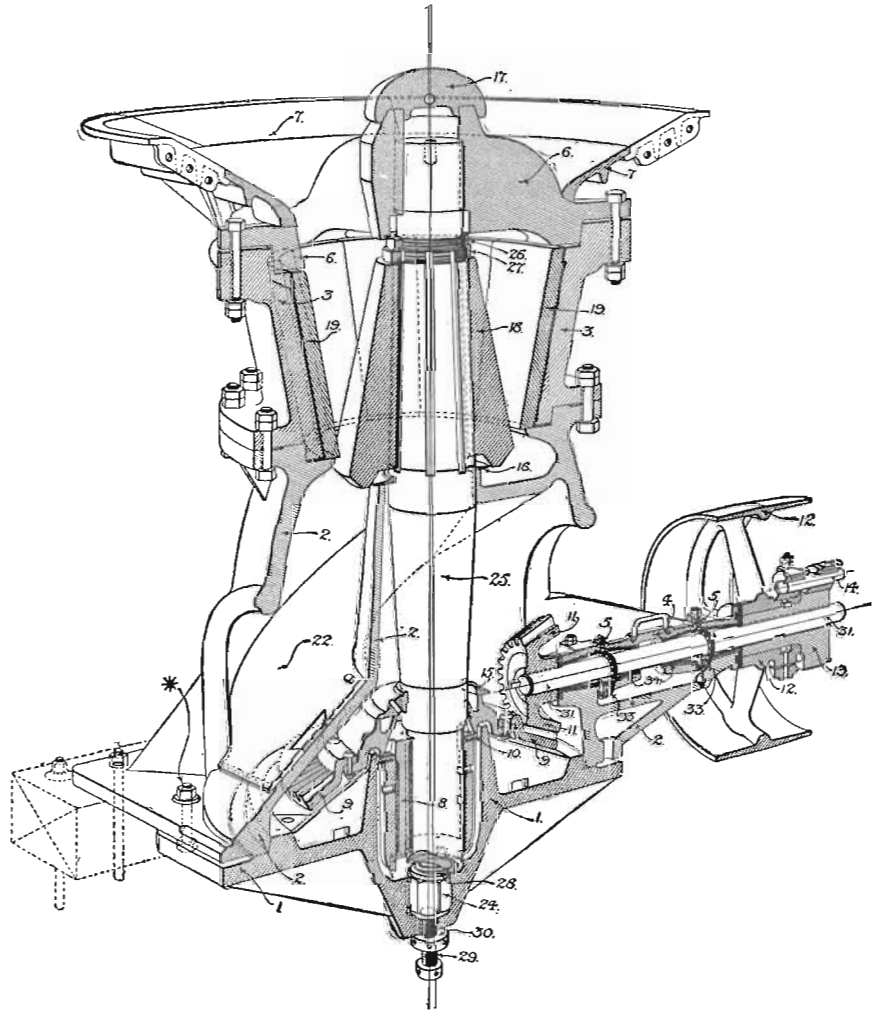

FIG. 7. Sectional view of the Jaw Type of Rock Crusher.

outlet somewhat enlarged. This back and forth motion of one side of the hopper allows the rock fragments to gradually progress downwards until they are fine enough to pass the exit opening. The size of the crushed material is dependent of course upon the size of the exit. In some machines this is adjustable. A modification of this, though based upon the same principle, is the cylindrical hopper in the center of which is supported a gyrating cone-shaped metal head with corrugated surface. This central cone is propelled from below by gearing and an eccentric arrangement which imparts to it the gyratory motion. This class of crusher has a greater capacity than the so-called "jaw breaker." It requires little more power to operate, is adjustable and also applicable to a larger range of rock material. The capacity of these crushing devices will vary from two to two hundred tons per hour, depending upon the character of the rock. They may be made to break as fine as three-eighths inch and as coarse as desired. In the clay industries, crushers are available for breaking only dry and the most brittle material. To reduce an indurated shale or stony fire clay they may be employed. The property which clay possesses of packing, and thus apt to clog, when subjected to pressure, although it may apparently be perfectly dry, renders any machine which comminutes by crushing inapplicable except to a very limited extent in clay manufacture.

Rolls.—Crushing rolls are used to a considerable extent in the clay industry, as a means of preliminary preparation of both dry and wet clay. Typically they consist of two revolving rolls between which the clay passes. The rolls are set distances apart according to the size of the clay particles desired in the crushed product. In some machines provision is made for adjusting the rolls in order to regulate the size of the particles passing between them. The range of size which rolls will take depends upon the diameter of the rolls themselves and the distance they are set apart. The more uniform are the lumps of clay given to the ma-

chine the more successfully will crushing be accomplished. In installing a machine of this sort, an accurate knowledge of the character of the clay to be fed to it would be necessary in order

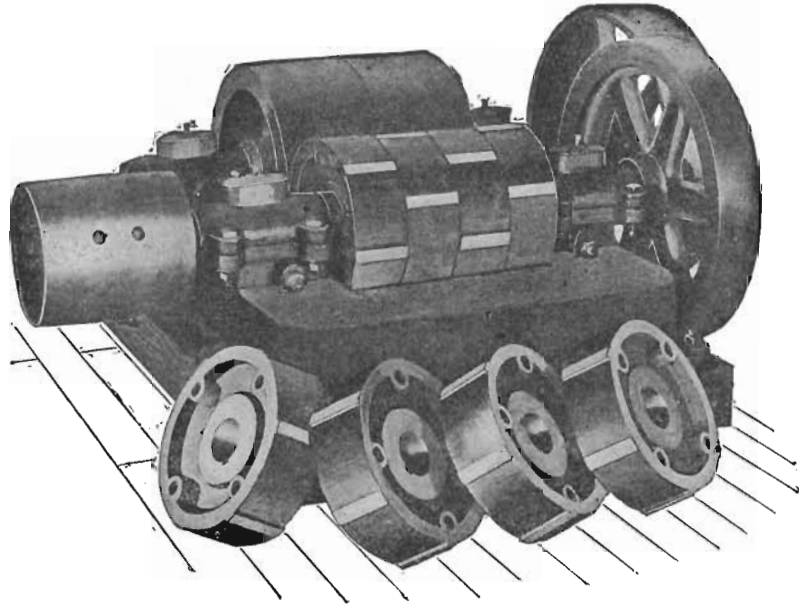

FIG. 8. Clay Crusher, Corrugated Rolls Type.

to select a machine that would give the highest possible efficiency. There are many modifications of this simple type. In a crusher with rolls of the same diameter and which are driven at the same speed the force which breaks the rock fragments is truly a crushing force and that alone. If the size of the two rolls varies, or if they are revolved at different velocities, an additional strain is brought upon the clay particles in the form of rubbing friction. They are not only drawn in between the rolls which tend to crush them, but they are subjected to the rending influence of friction or rubbing between the clay and the roll. This fact is made use of in the construction of this class of machinery, a large, slowly moving roll serving to draw in the raw material while a rapidly revolving smaller roll furnishes the real disintegrating energy. Often the rolls are armed with pro-

jections which tend to knead the clay more or less as it passes through. These projections are in some cases rows of steel lugs or pins, and in some a series of knife edges or cutting bars set in the surface of one or both rolls. Rolls used more especially in the softer clays are often faced with corrugations or winding

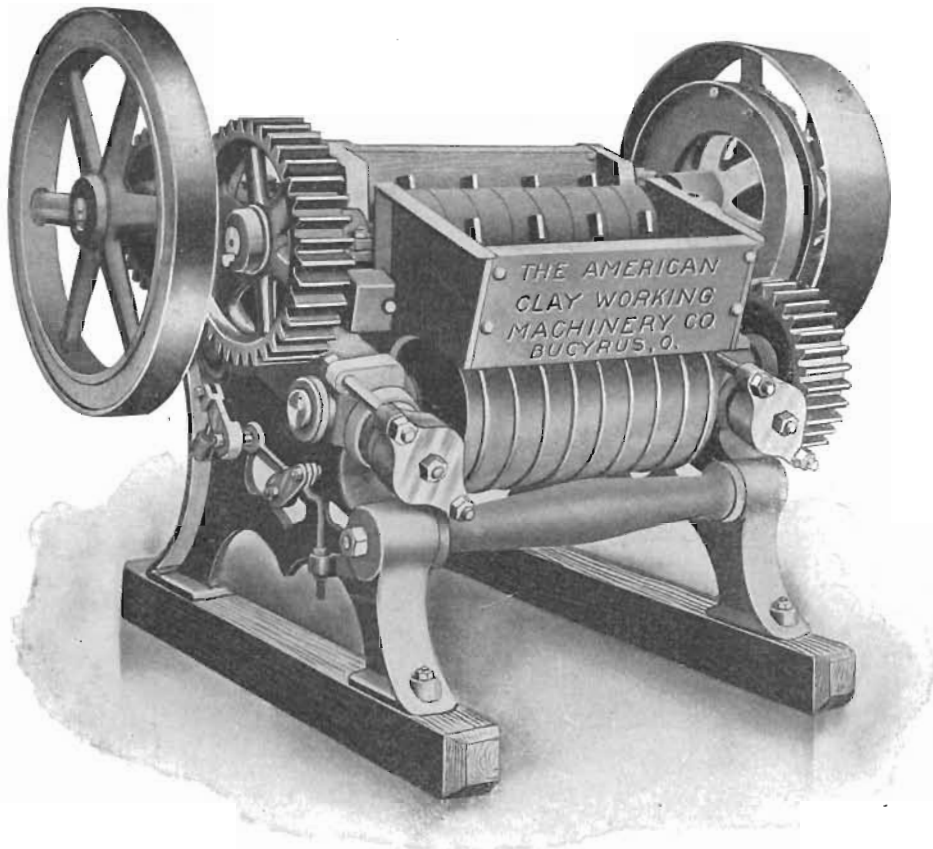

FIG. 9. Clay Crusher, Corrugated Rolls with Automatic Relief Feeder.

thread. Their kneading power is greater than the smooth or lugged rolls and they are more effective in removing any large lumps or stones from the clay. Such large or hard fragments which the rolls will not catch are gradually carried along the pitch of the thread until cast off at one end of the roll.

The excellence of the smooth conical roll depends also upon its ability to remove foreign material. Limestone or other pebbles beyond a certain diameter may be sorted from loamy or glacial clays, the revolution of the rolls carrying them towards the end having the larger diameter, where they are discharged. A set of average sized rolls will prepare clay for 25,000 to 150,000 brick (95 to 570 tons of clay) per day, depending upon the speed at which it is run, where the clay is of such a character as to require no other preparing machinery.

Disintegrators.—Where variations in construction are brought in so that the machine becomes more than a mere crushing de-

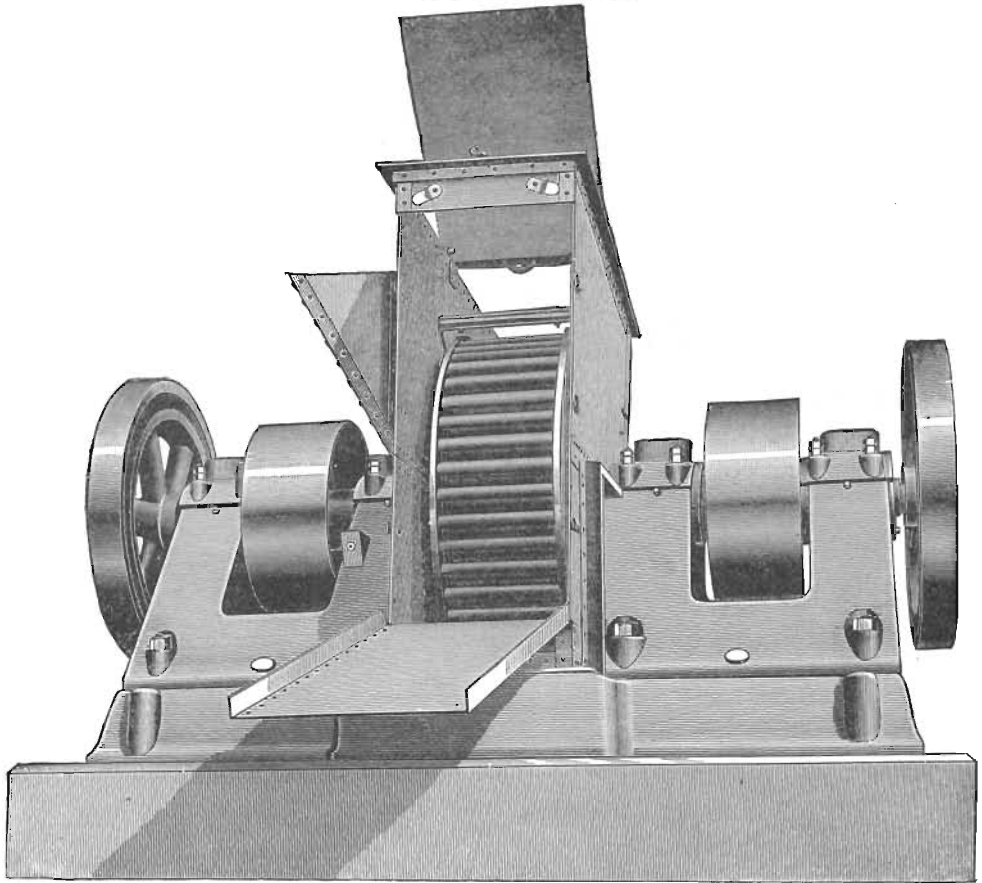

FIG. 10. Clay Disintegrator and Pulverizer of the Steadman Type.

vice the term disintegrator is applied. Among disintegrators, two broad divisions may be made, those that pulverize partly by crushing and in part by rubbing, and those in which comminution is accomplished by the force of impact. The former are exemplified in the modified rolls considered above; the latter by two characteristic types, among which may be mentioned the Steadman Improved Disintegrator, the Simpson Compound Pulverizer, and the Williams Pulverizer. The Steadman machine consists of several revolving cages one inside of another.

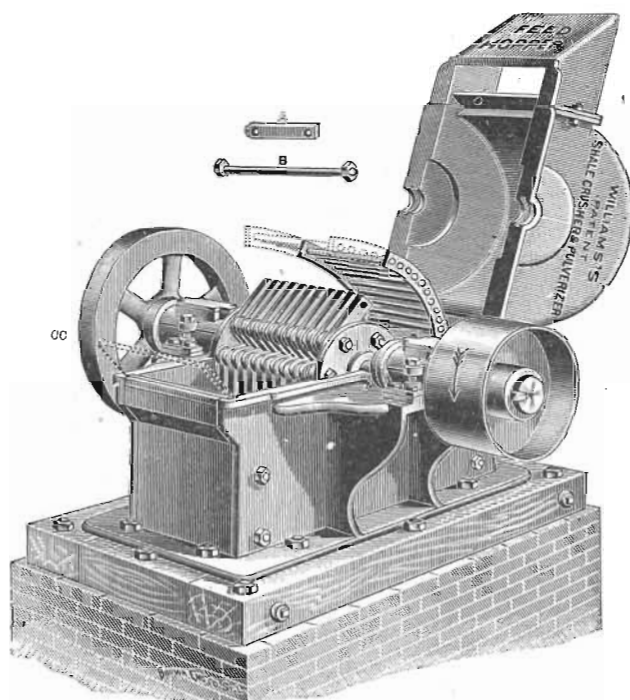

FIG. 11. Williams' Disintegrator and Pulverizer.

In operation, each cage turns in an opposite direction from the cage next outside of it. The clay is fed into the innermost cage and is carried outward by the centrifugal force of revolution through the bars of the consecutive cages. By impact with the bars and among the particles themselves, the clay is reduced

to a powder. The velocity of revolution is adapted to the particular clay to be ground and to the degree of fineness required.

The Simpson and Williams machines, which will illustrate the other type of impact pulverizer, are similar in principle of construction. They consist essentially of series of bars or hammers attached to a rapidly revolving shaft. One series is revolved in one direction at a high velocity, a second series in an opposite direction. These hammers are swung from one end so that they fly outwards by centrifugal force. The clay is supplied through a hopper from above and is broken up by impact with the swinging hammers. Disintegrators are employed most advantageously with dry clays and in the dry clay processes of manufacture but are also recommended for plastic materials. Their capacities vary with the clay and with the speed of revolution. They are made with capacities of from 60 to 400 tons of clay per day and require from ten to forty horse power.

Dry Pans.—The dry pan crusher is employed to a greater extent than any other grinding machine for shale and other hard and lumpy clays. It has a wide range of usefulness because of its ability to pulverize any hard material, from worn-out fire bricks for use as grog, and hard limestone in the cement industry, to the less refractory classes of raw clays. The machine consists essentially of a revolving metal pan above which are supported two large mullers which, in different sized pans, range in weight from two to three tons. These mullers are held in position by horizontal shafts. In some machines both are mounted on the same axle, while in others the axle is divided and each roller is allowed to act independently of the other. The extremities of the axles are set in grooves so that the latter are free to move up and down as the mullers encounter large or small lumps of clay. An advantage is found in the segmented axle in the fact that the movements of one muller do not affect the other. Where the shaft is continuous, the rising of a muller on

one side imposes an extra strain on the opposite one which may loosen it or tend to wear off its outer rim excessively. The mullers are actuated through contact with the revolving pan. They are commonly allowed to rest their whole weight on the pan floor so that each particle passing beneath them is subjected to a crushing force equal to their actual weight. For use with bowldery clays where it is not desirable to crush the harder pebbles to a fineness such that they will pass the screen plates in the pan bottom machines are constructed in which the muller bearings are carried on strong springs so that they will easily ride over an obstacle without necessarily crushing it; or in some cases the crushers are suspended a small distance above the pan bottom and clay passing under them is necessary in order to start them into motion. This style of pan is used in the reduction of soft glacial bowlder clays or of those containing objectionable concretions of any kind which are considerably harder than the clay mass proper. The inner portion of the pan floor, upon which the mullers rest, is solid. The outer portion has a perforated bottom and the clay after passing beneath the rollers is carried outward over the screen plates by the centrifugal force of revolution. The mesh varies with the clay and with the degree of fineness desired, but the majority of pans are made with three thirty-seconds or one-eighth inch perforations. All material failing to pass this mesh is gathered in by scrapers set so as to throw it again immediately in front of the revolving mullers. The ground clay passing the screen plates is caught in a receptacle beneath the pan and concentrated at the foot of an elevator which conveys it to the screens.

Dry pans are constructed with either wood or steel frames. Whatever the material of the supporting framework, it must be substantial and built to withstand constant jar and heavy jolting. The steel frame is more rigid and affords less relief for any extra strains brought upon the machine than does the wood,

which, while it must of necessity be more massive and clumsy, has a certain give and elasticity that enables the working parts to adjust themselves to all varieties of usage. On the other hand, the wood frame while requiring less care in operation, is, on account of the constant jar, much more apt to get out of true line because of loose bolts, etc., than are the steel frame pans. The initial cost of a wood frame pan is low but the expense for repair is usually greater than for steel. The elasticity that a wood frame possesses means the consumption of more power in operating than with a perfectly rigid frame.

The revolving pan is propelled through a vertical shaft with a heavy cogwheel pinion either below the pan or at the top of the frame above the mullers. The top gearing is almost universally used as it is up and out of the way and not so subject to the effects of dust and grit as it would be if located beneath the pan. Perhaps the most vital point in the construction of the dry pan is the support or "step" beneath the pan which carries as dead weight practically all of the working parts of the machine. Not only must it support this load, but its bearings must be such that it can do this and at the same time serve as a center of revolution for the pan itself. The pan should be well balanced and means provided for constant and perfect lubrication of the parts of this bearing as it is difficult to make it dust proof and it will soon cut out or continually heat by friction. Several patent "steps" have been devised, some of which have attained a greater or less measure of success.

Dry pans are made from five to nine feet in diameter with mullers having eight to fourteen-inch face. The power required to drive one of these pans depends upon the materials to be ground and the degree of fineness. So far as economy is concerned, they are wasteful, but no other machine has been found that will replace the dry pan with an equal expenditure of power. Likewise, its capacity is variable. With an average dry clay, it

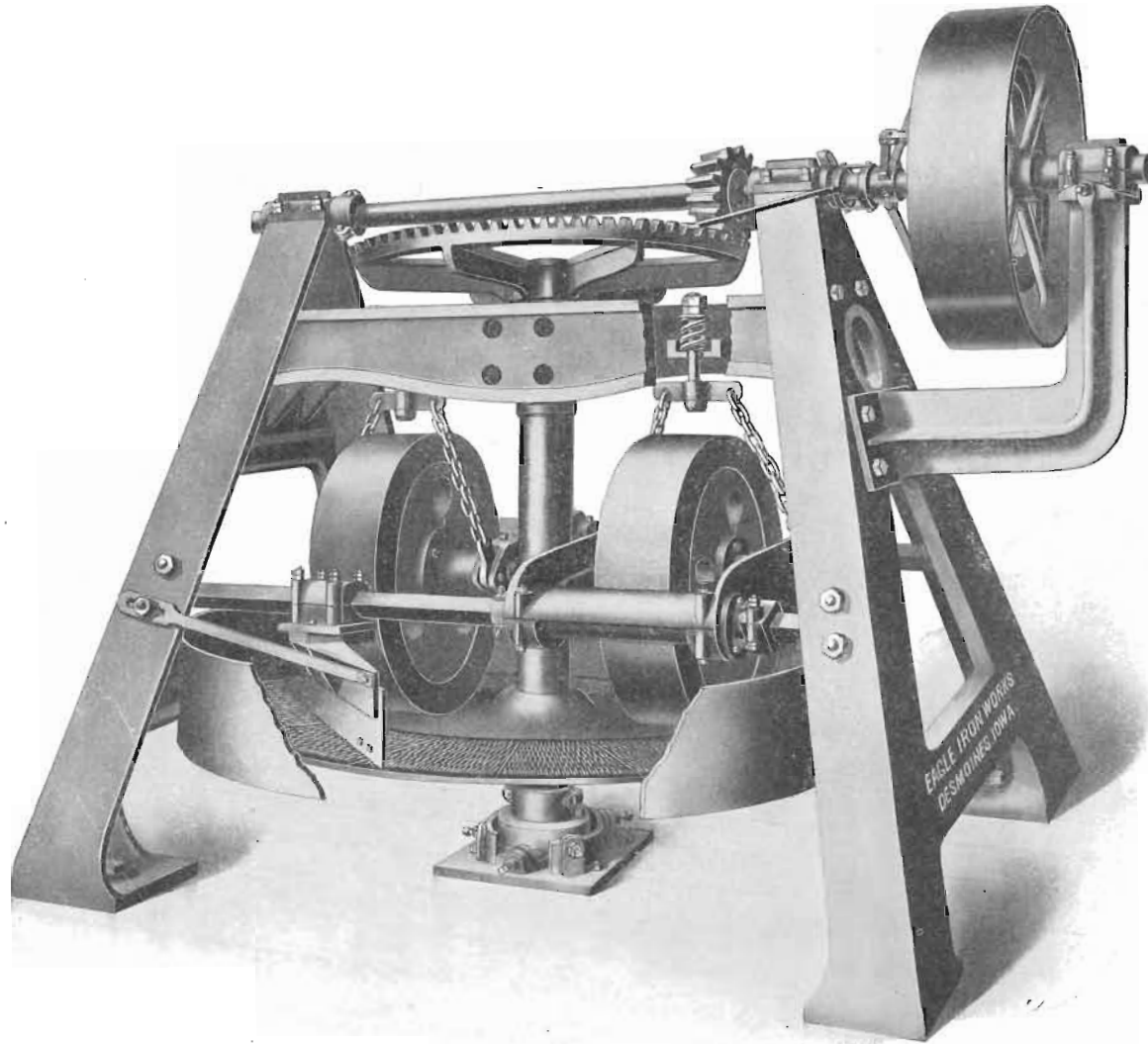

PLATE IV. Standard nine-foot Dry Pan with Steel Frame and Up-to-date Improvements.

may be said that a nine foot pan will pulverize to pass a one-eighth mesh screen over one hundred tons per day of ten hours.

Ball Mills.—Ball mills are employed in the preparation of clay in the manufacture of some of the finer grades of wares, where fine grinding and intimate mixture of ingredients is especially important. They consist of a hollow cylinder that rotates on a horizontal axis **and into** which the clay to be ground is admitted through an **opening at** one side or end. The machine is charged with the clay and balls (which fill about one-third of the volume of the cylinder) of some hard material, quite commonly iron, although where it is essential that the clay be as free from iron as possible, porcelain balls, or water worn Iceland flint pebbles are used. The material is pulverized by abrasion or rubbing friction between these balls as they are caused to move upon each other by the rotation of the cylinder. There are two principal types of ball mills which may be designated as the intermittent and the continuous. The former are those which are run with a given charge until the requisite degree of fineness is attained when this is removed and another charge put in. This class of apparatus may be used to grind either in the dry state or with the clay suspended in water as a slip. The latter or continuous class includes the more improved types of ball mills for turning out a large product of fairly finely ground materials. They are so arranged that the raw ingredients are fed in at one end of the rotating cylinder and gradually work their way towards the other end, becoming finer and finer until they are discharged in the desired state of comminution when the opposite end of the drum is reached. The continuous ball mill is in use very little, if at all, in this country but is rapidly coming into use in Germany. The periodic mill is used to some extent by the potteries of this country.

With the exception of the shales, the large number of clays are, as they come in from the bank, already in a partially

weathered or plastic condition. It is, therefore, not necessary to grind these clays before water is added for tempering, but grinding, mixing and tempering may be accomplished in the same operation. Such clays as may have concretionary matter scattered through them, which must be finely divided and thoroughly disseminated throughout the mass before molding, require the use of a crushing device to attain this end.

WET METHODS OF PREPARATION.

Wet Pan.—As has been noted, some styles of rolls will work with plastic clays, and some disintegrators will pulverize either the wet or the dry clay. Ordinarily, however, either apparatus must be accompanied by some other machine to complete the tempering. By tempering is meant the process of working the clay up to the plastic state with water. For grinding and tempering in the same operation, where the clay has come from the bank in the plastic condition or has come from some other grinding machine, the wet pan has given good satisfaction. In construction, the wet pan does not differ essentially from the dry pan, consisting of a revolving pan in which grinding is accomplished by two heavy mullers. The mullers are usually somewhat narrower and the floor of the pan is solid instead of perforated as in the dry pan. The clay may be shoveled or spouted into the wet pan, the proper amount of water is supplied, and the clay is ground and mixed to the required consistency. Without stopping the machine, a charge of tempered clay is usually transferred from the pan to a conveyor by the operation of a shovel mounted on a pivot close by the pan. The work of a wet pan can scarcely be said to be continuous as it is necessary to treat each charge separately, then remove it before more clay can be supplied. Because of this fact, it has a smaller capacity than a dry pan of corresponding size and it is fully as wasteful of power. But even under these conditions, the machine is doing double

work, that of grinding and tempering, and no other machine has been shown to be so effective as this. In the stoneware potteries of the state, and in the sewer pipe factories, the wet pan is employed, in some cases, as the soil clay preparing apparatus and it is peculiarly efficient for blending clays of different natures into a homogeneous body. If used on clay direct from the bank, however, since there is nothing to serve the purpose of a screen, there is always a chance that small lumps may evade the crushing mullers and find their way into the ware unground; so that in applying the wet pan to any clay, there is always this limitation to be borne in mind. A modification of the wet pan called the chaser or "tracer" is used to some extent in the stoneware potteries. The general plan of this machine is the same as the wet pan but instead of the moving pan, the rolls are made to chase each other in a stationary pan. In some machines of this type, the mullers follow in a circle of constant diameter; in others, they are made to trace a spiral course gradually approaching the circumference of the pan, then receding towards the center, thus covering substantially the whole pan bottom in the course of a few revolutions.

Pug Mill.—Like the wet pan, the pug mill is frequently used alone for commingling and tempering plastic clays. Its main use, though, is in conjunction with other machinery by which the clay is given a preliminary preparation. The pug mill is used more than any other machine for tempering clay, in the manufacture of paving brick especially, but also largely in the drain tile and building brick industries. The pug mill consists of a semi-cylindrical trough, usually of steel, though sometimes made of wood, in which a series of projecting knives is mounted on a revolving shaft. The steel shells are made from six to fourteen feet long. The knives are set spirally around the shaft and each placed at an angle with its plane of revolution. The clay is thus gradually pushed forward

by the revolutions of the cutting knives with a velocity depending upon the angle at which the blade is set and upon the speed of revolution. Quite stony clays may thus be reduced without the aid of any other preparing machine, especially if the pug mill is of the closed-top pattern. In the closed-top mill, the clay is worked under pressure, which gives the cutting knives much greater effectiveness than in the open-top machine.

The common pug mill is, however, pre-eminently a mixing machine. It is efficient for tempering powdered raw clays, in mixing them with sand, chamotte or other non-plastic matter, and in blending clays of different character. The capacity of pug mills is difficult to state, depending so much on the dimensions of the mill and the nature of the clay. With a good working clay, a pug mill will temper clay in ten hours for 25,000 to 60,000* brick, according to its size.

For wet clay preparation, the wet pan and pug mill already referred to constitute the most modern devices. Because of their historical interest, however, and since they are still in use in the state to a limited extent even at the present day, should be mentioned the primitive soak pits and wooden-armed pug mills. These were the only clay-tempering devices used before the manufacture of clay goods from clays and shales which require grinding was undertaken. They are still employed in working only the loess and alluvial clays and well weathered, plastic shales.

Soaking Pit.—The pit for soaking is dug in the ground to a depth and size depending upon the capacity required, usually four or five feet deep and six to twelve feet in diameter. It may be rectangular or circular.

The clay is shoveled into the rectangular pit, wet with water, and simply allowed to stand till thoroughly permeated. This may take over night, after which the clay is shoveled out to the

* H. Ries. Clays of New York. Bulletin 95, N. Y. State Museum, p. 660.

pug mill. The old style wooden pug consists of an upright enclosed framework inside of which revolves a vertical shaft set with projecting wooden arms. To the upper end of this shaft is attached a sweep, by means of which the mill is operated by horse power. The clay is put in at the top, well worked by the pugging arms, and issues at the bottom ready for molding.

Built on a circular plan, the pit is usually not so deep but larger in diameter and is walled up with boards or brick. The object in making it this shape is to provide for tempering and mixing at the same operation.

The clay is shoveled in, water and sand added, and the mixing is accomplished by the revolution of a heavy wheel, so supported that in the course of a few circles it covers practically the whole area of the pit from center to circumference. At the end of this process, the clay goes to the molding machinery.

The same style of mixer is made use of to some extent in preparing impure clays for earthenware and stoneware manufacture. In these instances the clay is mixed and stirred and enough water furnished to bring it to the slurry condition. It is then tapped off at one side into a settling tank located at a somewhat lower level than the mixing pit. In passing from the mixing pit to the settler, the clay is run over screens, having 60 to 70-mesh openings. These sieves retain any concretionary impurities or other substances which have not been reduced to a very fine condition. As the slip passes over them, the sieves are constantly agitated and the concretionary or lumpy material is thrown off outside the tank. The water with the clay in suspension is usually allowed to stand until evaporation has left the clay at a workable consistency. With clays containing impurities, this is a very inadventagous method of procedure as on evaporation of the water all the dissolved salts are deposited in or at the surface of the bed of clay. An expedient in this case would be to tap off all supernatant water as soon as the subsidence of the suspended clay particles has left it clear.

SCREENS.

There are few, if any, of the different machines for grinding dry clays that reduce them to particles of such a uniform size that a later grading process is not required. Grading is accomplished by means of screens. Screens are made with meshes depending principally upon the size of particles to pass them although, as will be seen later, partly upon the style of screen employed. There are two classes of materials used in the manufacture of clay screens, wire netting and perforated metal. The former is much used, but less and less as the merits of the latter become known. The proportion of open space to solid metal in the perforated screen as now made approximates that of the wire screen, which gives it an equal screening power. The perforated screen being entirely in one piece is smooth, and there is not the chance for roots or other fibrous matter to lodge in the meshes that there is in the wire screen. It is thus easier to clean and to keep clean. The loosening of a single wire is apt to disable the wire screen while the metal is not subject to this disadvantage.

There are three chief types of screens, viz., the inclined stationary screen, the inclined vibrating screen and the rotary screen.

Inclined Stationary Screen: The inclined screen is essentially a rectangular trough, the bottom being covered with netting or perforated metal. Its length varies from ten to fourteen feet. The trough is inclined at an angle of thirty to forty-five degrees, according to the size of particle that is to pass the mesh of the screen, and the condition of the clay. It should be so supported that the inclination may be adjusted. The clay is brought up by an elevator from the grinding apparatus and dumped onto the upper end of the screen. Its fall over the screen is due to gravity alone and at a certain inclination will have a definite velocity; and

hence a specific maximum size of particle will pass the mesh under the conditions. This size of particle will be smaller than the absolute size of the openings. If the inclination is lowered, the particles passing the screen will approach the actual size of the mesh. The lower the angle, however, the more care is required to keep the screen clean. Clay passing through the screen falls to a trough below and is conveyed to a bin best located immediately above the tempering machine. Particles too coarse to pass the mesh of the screen run into a separate chute and are carried back to the pulverizing machine.

Inclined Vibrating Screen: The inclined shaking screen is similar in construction to the fixed screen except that it is much shorter and is set at such a low angle of inclination that mechanical aid is used to cause a continual downward movement of the stream of clay. The screen-bottomed trough is in this case swung by chains or springs or other means of support, so that either a longitudinal or a lateral movement may be given to it. This movement is imparted by either an eccentric or crank. The clay is thrown on the screen as before and if the impulse given to the screen be longitudinal, the clay is gradually carried downwards by repeated little jumps in the direction of vibration. If the vibration be transverse, the clay will be thrown from side to side and will move to the lower end of the screen more slowly than in the former case. Within limits, the longer the time required for the clay to pass the length of the screen the more perfectly will screening be accomplished, and in all instances with this style of screen, the maximum size of the particles passing it is approximately the diameter of the mesh. It is to be recommended in the use of this class of screen that sufficient play be provided in the vibrating device that a brief pause is allowed at the extremity of each swing. There should be provided solid blocks or posts against which the screen is brought to a sudden stop with each vibration. The repeated jar thus imparted with each swing is

very effective in keeping the meshes open, especially if the clay happens to be damp.

The operation of the shaking screen consumes considerable power and subjects the factory building to a continual jar, both of which are avoided in the use of the stationary screen. There is little difference in the cost of construction. Figuring alone on the basis of the amount of clay screened, the vibrating screen gives a much higher efficiency and they both require more or less constant attention while in operation.

Rotary Screens: There are two principal types of rotating screens, cylindrical and polygonal. The cylindrical screen is sometimes modified to the frustum of a cone. The polygonal is made with a varying number of sides and its cross section may be anything from the square to the dodecagon.

The rotary screen consists of an open framework covered or lined with screen material, either wire cloth or perforated steel plate. The clay is fed in at one end and that which does not pass the mesh makes its exit at the other. That which passes falls to a bin beneath. If the screen is a true cylinder or is prismatic in form it is set at a low slope so that its rotation will cause the clay to progress from one end to the other. If a section of a cone or pyramid, the taper of the screen itself will bring about the gradual movement of the clay. The screen is driven by gearing on a central shaft.

The framework, which is wood, is sometimes placed outside and sometimes inside of the screen. Advantage is claimed for the latter, for it tends to carry the clay farther up before it is dropped back with each revolution, thus giving greater screening power. This also consumes more power than where the inside is smooth. Similarly the polygonal screens have a greater capacity than the circular, owing to the ability to lift the clay higher before it is dropped back against the bottom of the screen. The screening force in the rotating screen is simply the force of impact of the

clay particles with the metal of the screen as they continually drop back, having been carried up by revolution beyond the stable angle. This force is not great and is one of the reasons why rotary screens ordinarily give more trouble to keep them clean than inclined screens. For the purpose of keeping the screens clean, several devices are employed. Some have brushes inside which by contact with the screen clear it of adhering and wedged particles and keep it from clogging. Such metal brushes are often placed on the exterior, but in either instance their contact with the screen must be so heavy and continuous that the metal is rapidly worn away. In fact, the brushes in many cases determine the life of the screen. Automatic pounding instruments are resorted to to accomplish the same end. Short pieces of chain or heavy rope or wood are fastened to a rapidly rotating shaft above the screen and as they swing round keep up an incessant pounding on the outer surface of the screen. This is fairly effective but it is damaging to the screen.

Of the types discussed, the fixed inclined screen is the cheapest in construction, needs the least repair and requires no power to operate. Because of its necessary length, it requires a higher building than the others and consequently the elevation of the

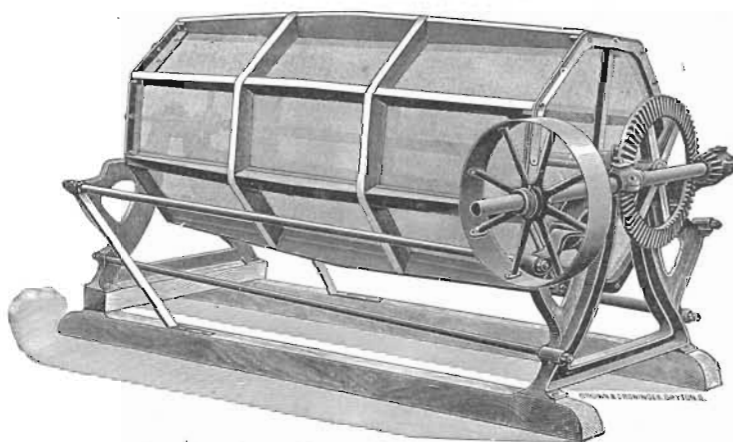

FIG. 12. Rotary Type of Clay Screen (Octagonal).

ground clay this extra height. Its actual screening capacity is lower than either of the others, but can ordinarily be made ample to the demands of the plant.

The shaking screen is an efficient method of screening clay, though requiring some power to operate, and it is somewhat detrimental in its vibratory effect upon the building. Of the two kinds of shaking screens, the transverse has proved in general best. It requires less attention to keep it clean than any other screen in use and has a relatively high capacity.

Of the rotary screens, the polygonal form has greater capacity than the circular or conical, and any of the styles with the frame-

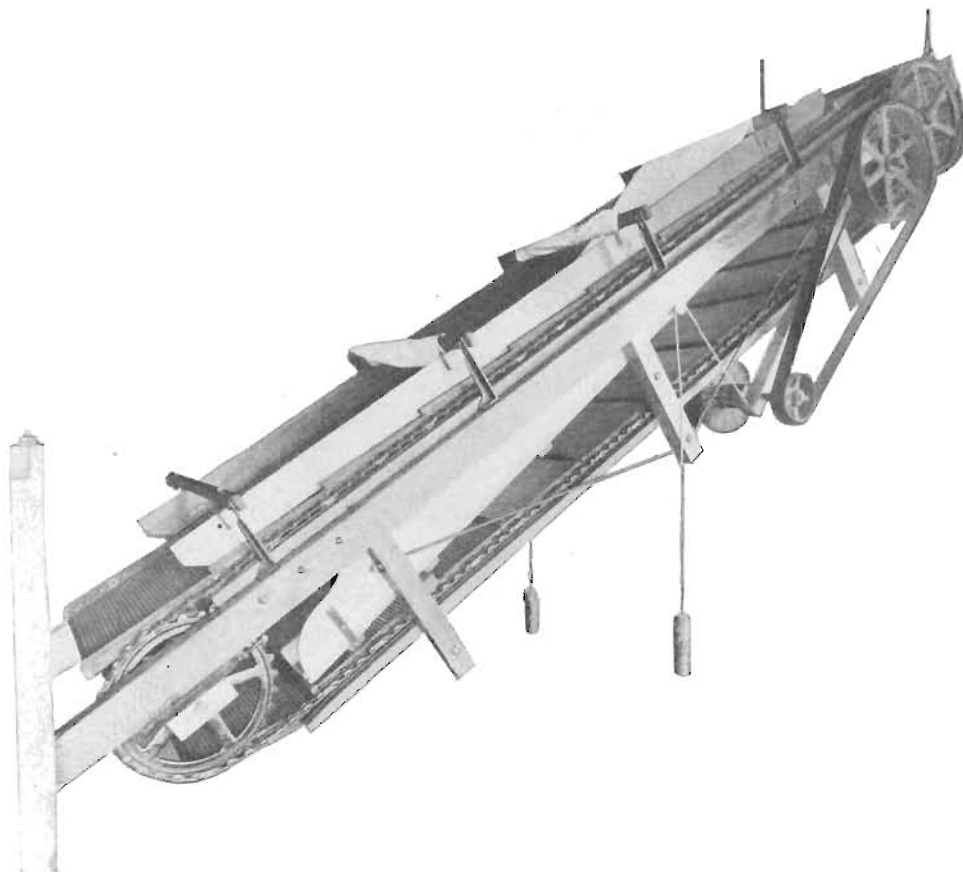

FIG. 13. Type of Revolving Clay Screen with Automatic Brush Cleaner.

work inside do better work than those with the exterior framework. Anything, however, which roughens or makes the inside uneven or angular, whether it lessens in extent the screening surface or not, necessitates the expenditure of a greater amount of power. The rotary screens all require more care than the inclined and are in general shorter lived.

The Dunlap Screen.—The Dunlap is a sectional revolving screen. The screen plates are attached to sprocket chains on each side and travel upward on an inclined framework. There are four attachments for each plate, two on each side, one attachment is at the forward edge of the plate and the other is at the center, permitting the plates to travel around the sprocket wheels without friction or binding. The screened clay after it passes through the perforated plates drops onto a floor which is between the upper and lower sheets of plates. The floor is more highly inclined than the screen, thus facilitating the delivery of the fine clay at the lower end where it falls onto the reverse side of the perforated plates and is discharged into a bin below as those plates circle the lower sprocket. The tailings flow over the lower end of the screen and are returned to the pulverizing machinery. Curtains may be supplied to retard the flow of the clay and a rotary brush is provided for cleaning the screen automatically.

Storage bins are usually provided for the reception of the ground clay. In a bin of considerable size, several cubic yards may be stored for use when the preparing machinery is not in operation. A convenient shape for the storage bin is that of a large hopper, broad above, with a long taper to a relatively small opening in the center of the bottom. The bin should be as high and its sides as steep as is feasible, since there is always the tendency of pulverized clay to pack and to bank up under the most favorable conditions. For this reason, if the clay is conveyed from the bin to the pug mill or auger machine by a

spout, the latter will furnish a more constant supply of clay and cause less trouble if it is large and uniform in size or even broader below than is the opening from the bottom of the bin.

THE FORMATION OF CLAY WARES.

In the following discussion of the manufacture of clay wares consideration is given only to the classes of products that are made within the state, viz., brick, tile, sewer pipe, hollow block and pottery. The outline indicates the different methods used.

| | | | | | |
|--|---|-----------|---|----------------|----------|
| Manufacture of brick | { | Wet..... | { | Soft mud... { | Hand. |
| | | | | Stiff mud... { | Machine. |
| | | Dry | { | Machine. | |
| Manufacture of drain tile and hollow block | { | Wet..... | { | Stiff mud... { | Machine. |
| Manufacture of sewer pipe | { | Wet..... | { | Stiff mud .. { | Machine. |
| Manufacture of pottery | { | Wet..... | { | Hand. | |
| | | | | Machine. | |

MANUFACTURE OF BRICK.

As indicated in the outline, the wet method of brick making may be subdivided into the soft and stiff clay processes. In the first instance, the clay is mixed with a larger percentage of water than in the last, and because of its resulting soft and muddy nature requires different treatment. Measures must be taken to prevent the clay sticking to the molds. The large amount of water necessitates extra precautions in drying. The clay will shape more readily but is more easily deformed while wet.

Soft Mud: The primitive way of molding brick was by forcing the wet clay into wooden molds by the hands. On the smaller yards this method is still employed at the present time. The clay is usually mixed in the wooden armed pug mill de-

scribed on a preceding page. It is forced out in a heap at the bottom of the mill on the opposite side from the soak pit from which the clay is shoveled into the mill. The "molder" takes

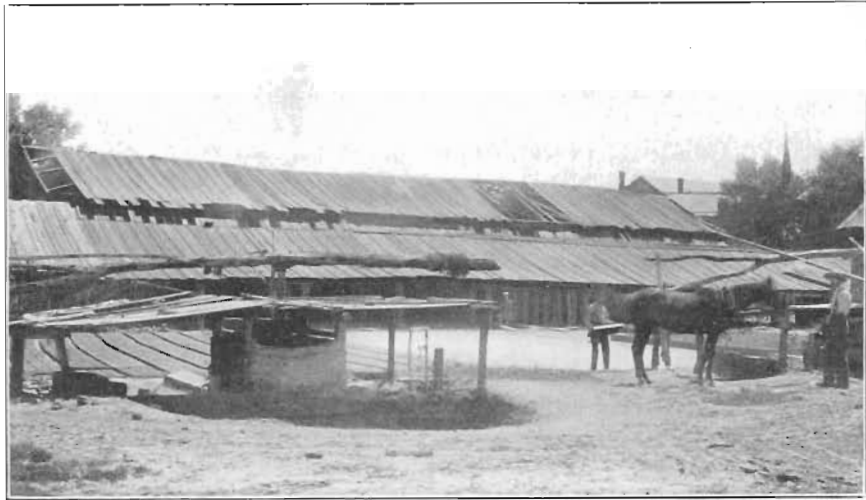

FIG. 14 Soaking Pit and Wooden Pug Mill, Carl Hagemeister, Muscatine, Iowa.

with the hands, pieces of the clay of sufficient size to make one brick, and brings it forcibly down into the mold which has been previously sanded. The clay is of the correct consistency, when it will just retain its shape, and yet is soft enough to fill the mold

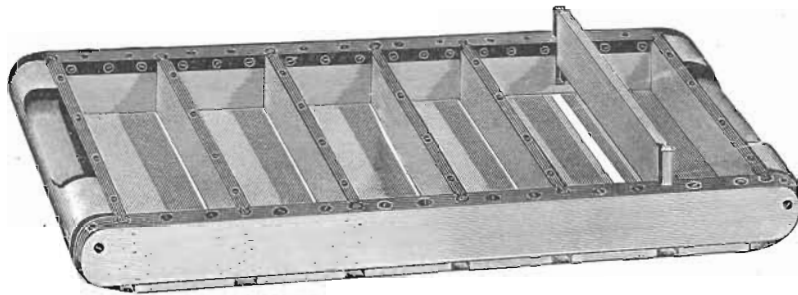

FIG. 15. Common Brick Mold for Soft Mud Brick.

perfectly. The molds are made in frames, each frame containing four to six or seven each. At each end of the frame is a handle, so that it may be carried. When a section is filled the

top is stroked off even with a small wire or thin blade to which handles are attached. The "offbearer" then takes the filled molds to the dry yard, where the bricks are turned out on the ground to dry, or empties them onto pallets and places them in racks under sheds. One man will mold four to five thousand brick in a day.

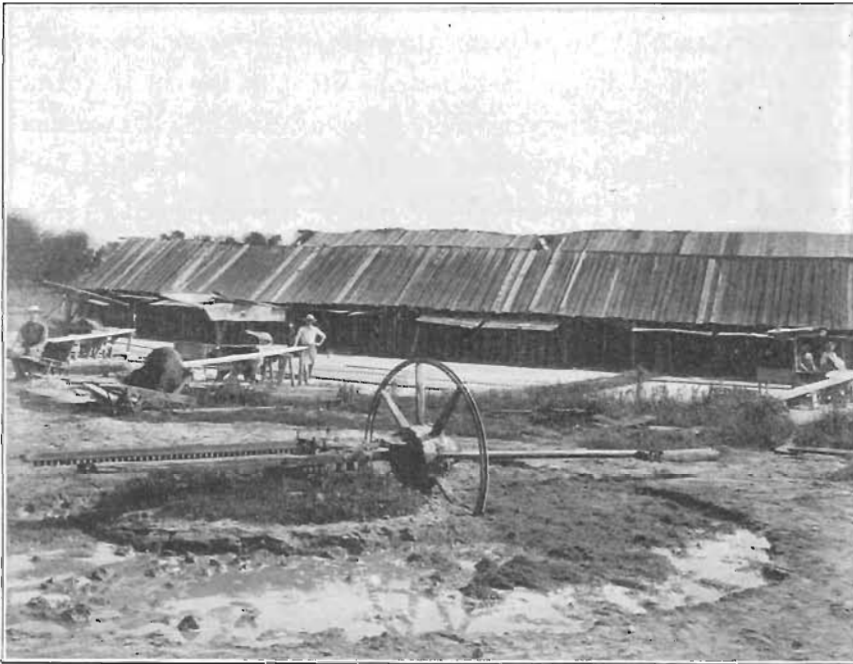

FIG. 16. Ring Pit, Carl Hagenmeister, Muscatine, Iowa.

On some yards the clay is tempered in ring pits located at the border of the drying yard. From these pits the clay is commonly hauled, a wheelbarrow load at a time, to portable molding tables, situated centrally on the yard. Each molder shovels and hauls his own clay and dumps his brick on the yard after molding. It has been found advantageous to engage workmen on the basis of so many brick delivered on the yard as a day's work. An average molder employed on this basis will make sixteen hun-

dred brick in six hours. If the demand is great, a premium is occasionally paid for extra work.

Soft mud brick are made with machines especially devised for working the clay into molds similarly constructed to those used in hand molding. The soft mud brick machine is built on both the horizontal and the various plans. It consists essentially of a pugging mill in the lower part of which the clay is forced into molds by means of press plates or plungers actuated by wooden or steel cranks. The molds to receive the clay are set in frames and hold from four to eight brick. They are fed into the machine from the side immediately beneath the press-box and, when filled are automatically pushed forward to the "striker off," who by means of a small wire or blade strikes the clay off even with the top of the molds.

The sanding of the molds is an important part of the process. They are either sanded by hand, that is, by pouring sand into each of the molds, which have been previously dampened the molds then being shaken and the sand dumped out; or by the use of a mold-sander. This apparatus consists of a rotary framework into which the molds are placed. The frame is rotated inside of a cylindrical shell in the lower portion of which is sand, filling the molds with the latter and dumping them as they go round. A good grade of fine sharp sand is best for this purpose.

The machine is ordinarily located so that the clay is dumped directly into it from above or shoveled into it from an elevated platform. The clay is at this point supplied with the correct amount of water for tempering. The persons necessary to operate the soft mud machine are, one to feed and temper the clay, one to strike off the molds, one to sand and feed the molds into the machine, two men to dump the bricks on pallets, three men to wheel to drying racks and place the brick, one to bring empty pallets to the machine and one to place pallets on the dump

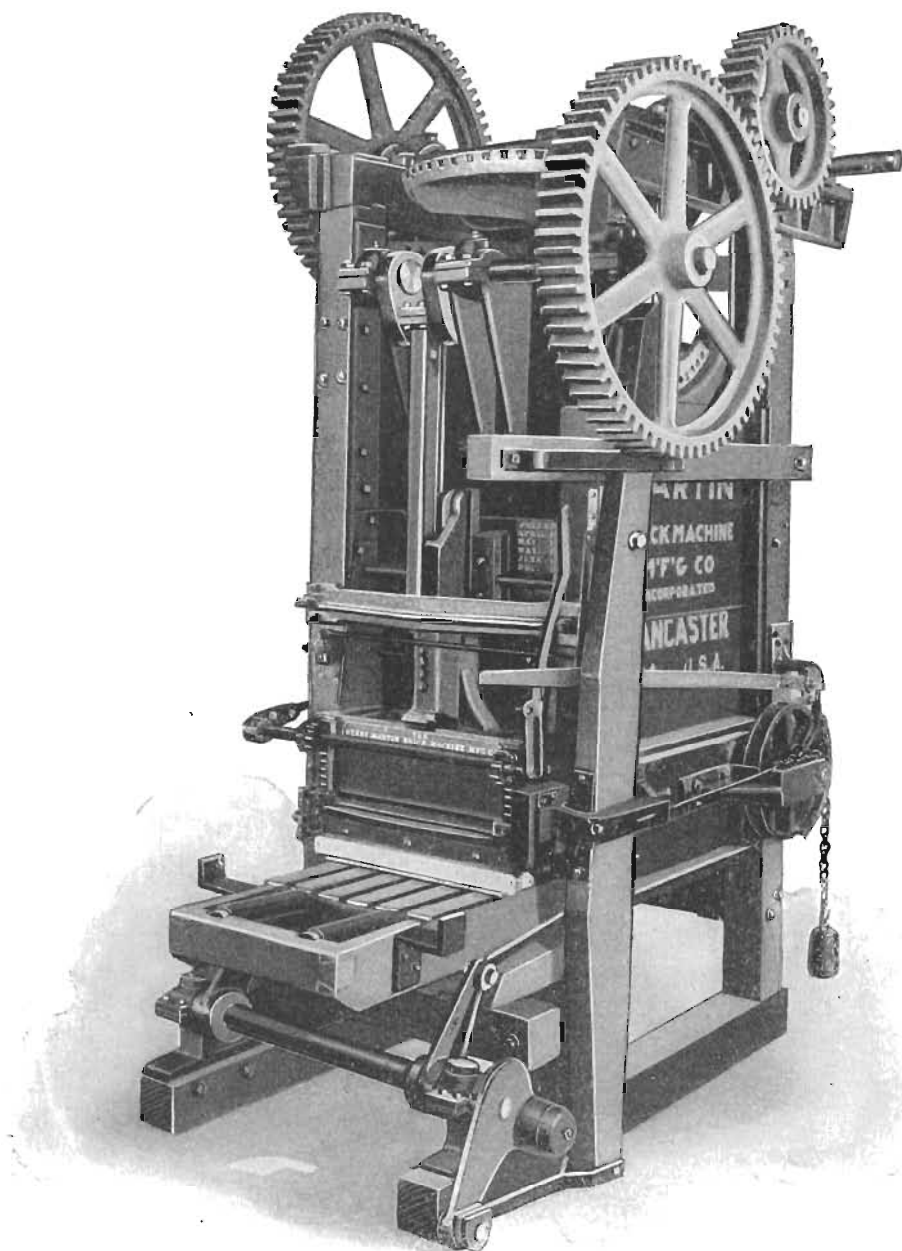

PLATE V. Vertical Type of Soft Mud Brick Machine

table. The last two tasks and also the sanding of the molds can usually be attended to by boys, which lessens the running expense. With this number of attendants, a soft mud machine with six molds will make 35,000 brick per day.

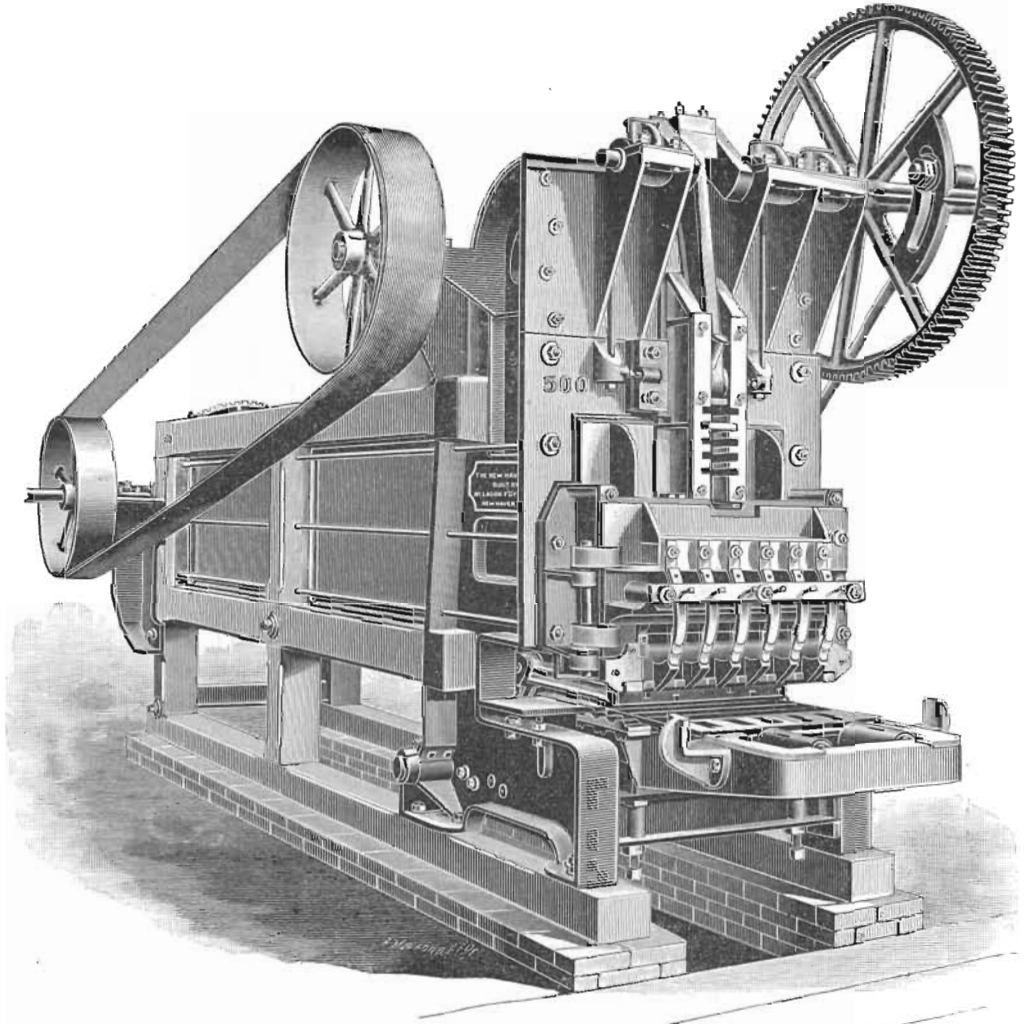

FIG. 17. Horizontal Type of Soft Mud Brick Machine.

The power required to operate one of these machines depends upon its capacity and the clay used. Only the softest, and those clays that will most readily temper to the plastic condition can be

successfully worked by the soft mud process. The alluvial, surface and loess clays are best worked by this process. These vary considerably in hardness, and tenacity when wet, but with an average clay a six-mold machine will require ten to fifteen horse power. Machines of small capacity are oftentimes operated by a team of horses.

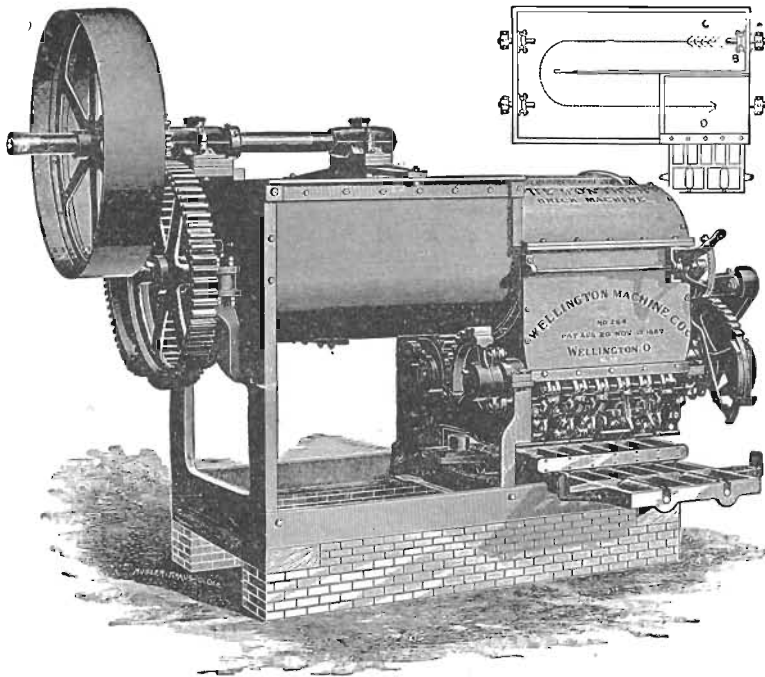

FIG. 18. Horizontal Type of Soft Mud Brick Machine.

The brick made by the soft mud process are of necessity less dense than those manufactured by the other methods. They are porous when burned, but this is a condition favorable to the development of good color and, indeed, when fairly hard burned, soft mud brick possess qualities of strength and durability. One effort of the brickmaker is always to obtain a product which is free from all signs of structure, so that one portion of a brick is exactly like all other portions of it. This comes nearest attainment in the soft mud brick. There are no augers to produce

lamination, and because of the free mobility of the wet clay, there is no chance for defects to arise from the pressing of the clay into the molds.

Stiff Mud: The term "stiff mud" signifies the distinction between this and the other processes of making brick. The clay is tempered to a stiffly plastic state so that it can be molded, but it will not shape or flow under slight pressure as does the clay when prepared by the soft mud process. The clay is made of such a consistency that it will, under heavy pressure, flow through a die in the shape of a bar, the latter being strong enough to retain its form even when subjected to considerable strain either longitudinally or laterally. It must yet be soft enough that under the pressure of coming through the die, stratification produced by the auger will be to the greatest extent eliminated.

There are two principal types of stiff mud machines: the upright and the horizontal. They both consist essentially of a small pugging chamber at the exit of which is the die that forms the bar of clay. On the same shaft with the pugging knives is an auger which is the means of forcing the clay through the die. Machines are constructed which combine pug mill and auger, thus providing for tempering the clay and forming the bar without the installation of two machines. The clay ordinarily comes to the brick machine from some preparing device in which it has been tempered and rendered thoroughly plastic. In the brick machine, the pugging arms carry the clay to the auger and the latter compresses it into the die. Through the action of the pugging knives and auger under heavy pressure the clay is strongly compacted and issues from the machine in a solid bar. The bar of clay is, however, seldom homogeneous. The face or end of a brick will often show laminations, frequently concentrically arranged either parallel to the length of the bar, or laterally, or both. Such laminations

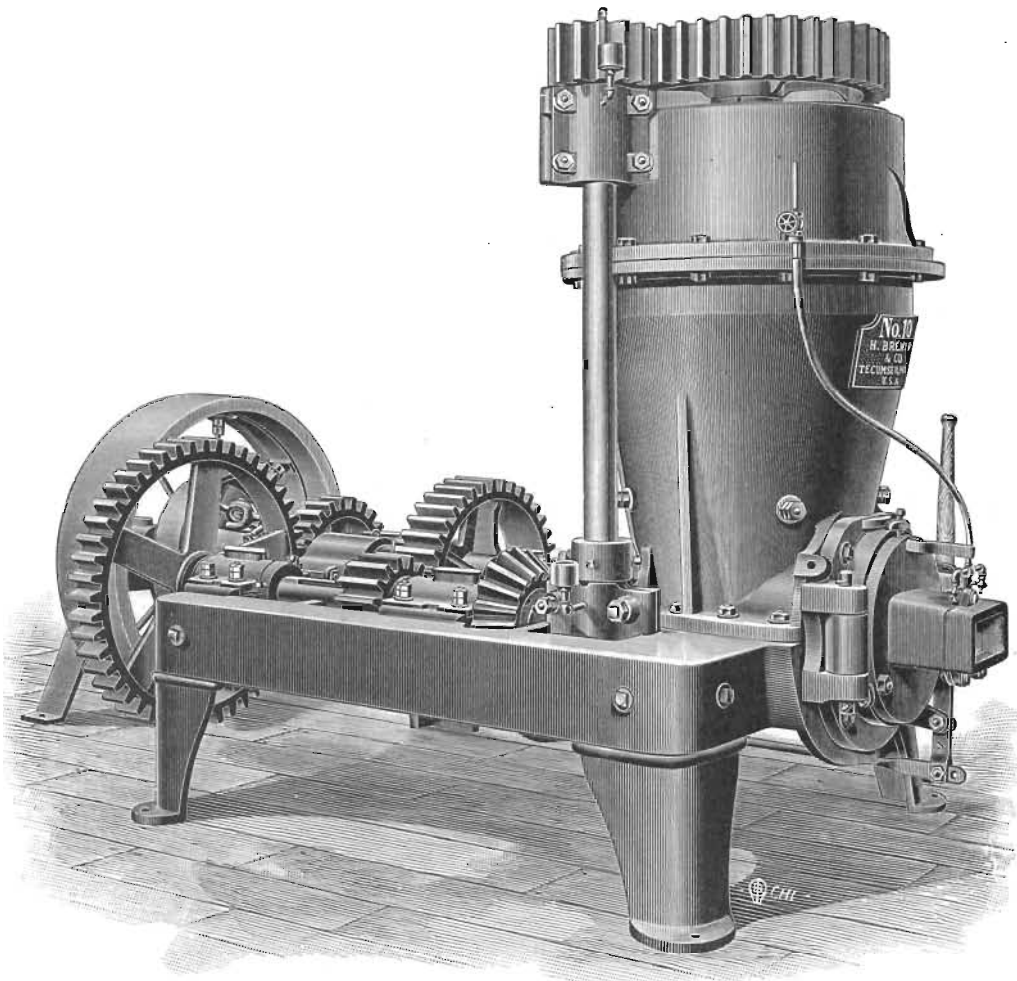

FIG. 19. Vertical Type of Stiff Mud Brick and Tile Machine.

are the result of the joint action of two main causes. The action of the auger screw on the moving clay is to arrange it in the bar concentrically around the center of revolution of the screw. The clay in sliding over the smooth surfaces of the spirals of the auger is polished and these polished faces when pressed together in the die do not fuse or amalgamate readily, and the lines of contact can usually be seen in the fresh bar or in the finished ware. If they are well developed, as is more often the

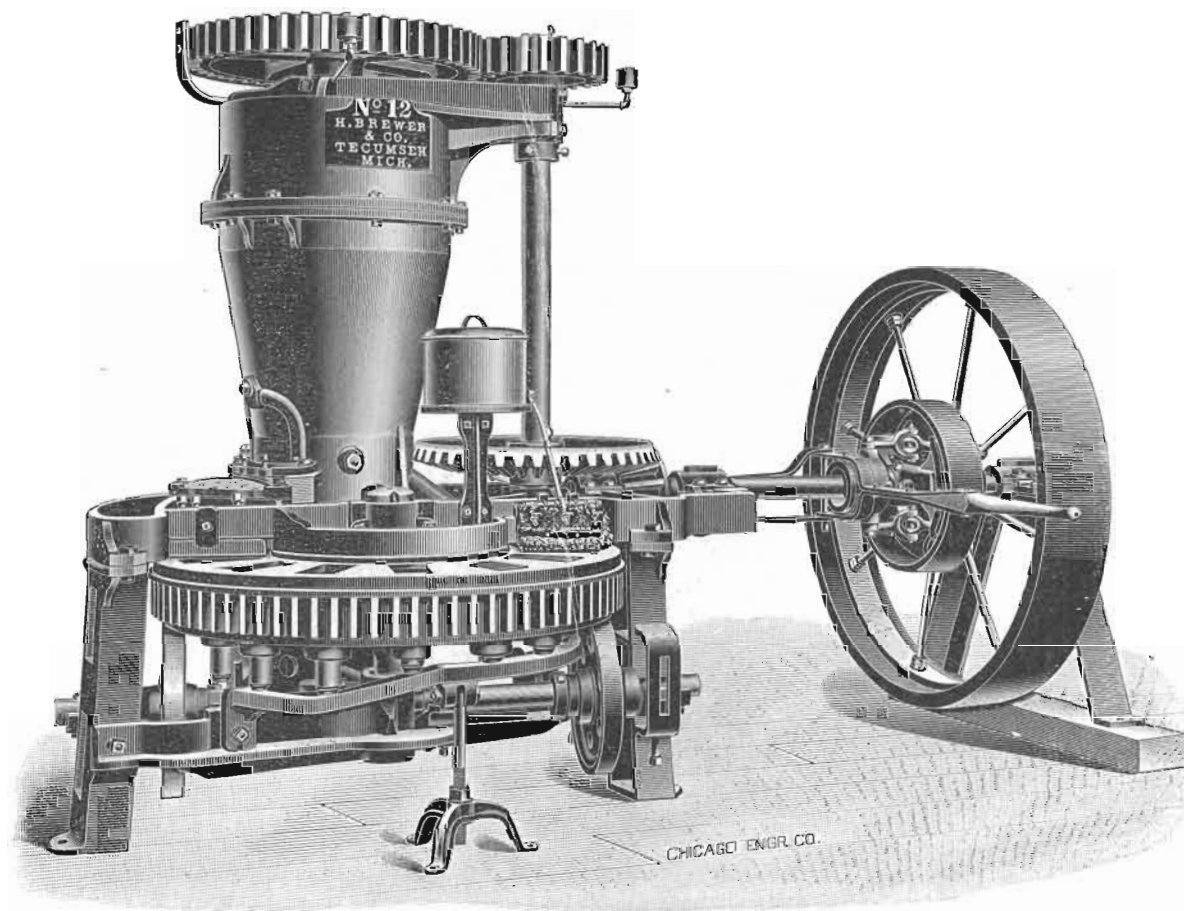

PLATE VI. Vertical Type of Mold Brick Machine.

case with the most plastic clays, the laminations become lines of weakness in the resulting brick. With the effects of the auger itself is the tendency of the flow of the clay through the die to exaggerate any defects that may exist. The planes of separation produced by the auger are elongated parallel to the movement of the bar by the more rapid flow of the center than of the outer portions of the bar of clay. This is due to friction in the die. Dies and augers of special design have obviated this difficulty to a considerable extent. Steam heating, steam and oil lubrication in the die are used to reduce the friction of the issuing bar. These means are also effective in avoiding the serration or tearing of the edges of the bar of clay.

All defects of structure may often be largely remedied by a thorough preparation of the clay before it comes to the auger machine. A very short and sandy clay will not work successfully in the auger machine, nor will an exceedingly plastic one give good satisfaction, because of its tendency to lamination.

The bar of clay runs from the machine onto a moving belt which carries it to the cutting table. The brick may be made "end" or "side" cut, according as the width of the bar of clay is the width or length of a brick. Any size of bar may be made from the same machine by providing different sizes of dies. Very commonly two or even three bars of the size for making end cut brick are run simultaneously from the machine.

Improved machines are provided with sand box which sands the bar of clay as it issues from the die. The primary use of the sand is to facilitate handling and to prevent sticking of the brick, but it is also held to be influential in giving good color to building brick in the burning.

The maximum capacity of the stiff mud machines making side cut brick is eight to ten thousand brick per hour, requiring seventy to seventy-five horse power. Auger machines of smaller size are on the market with capacities ranging from two thousand

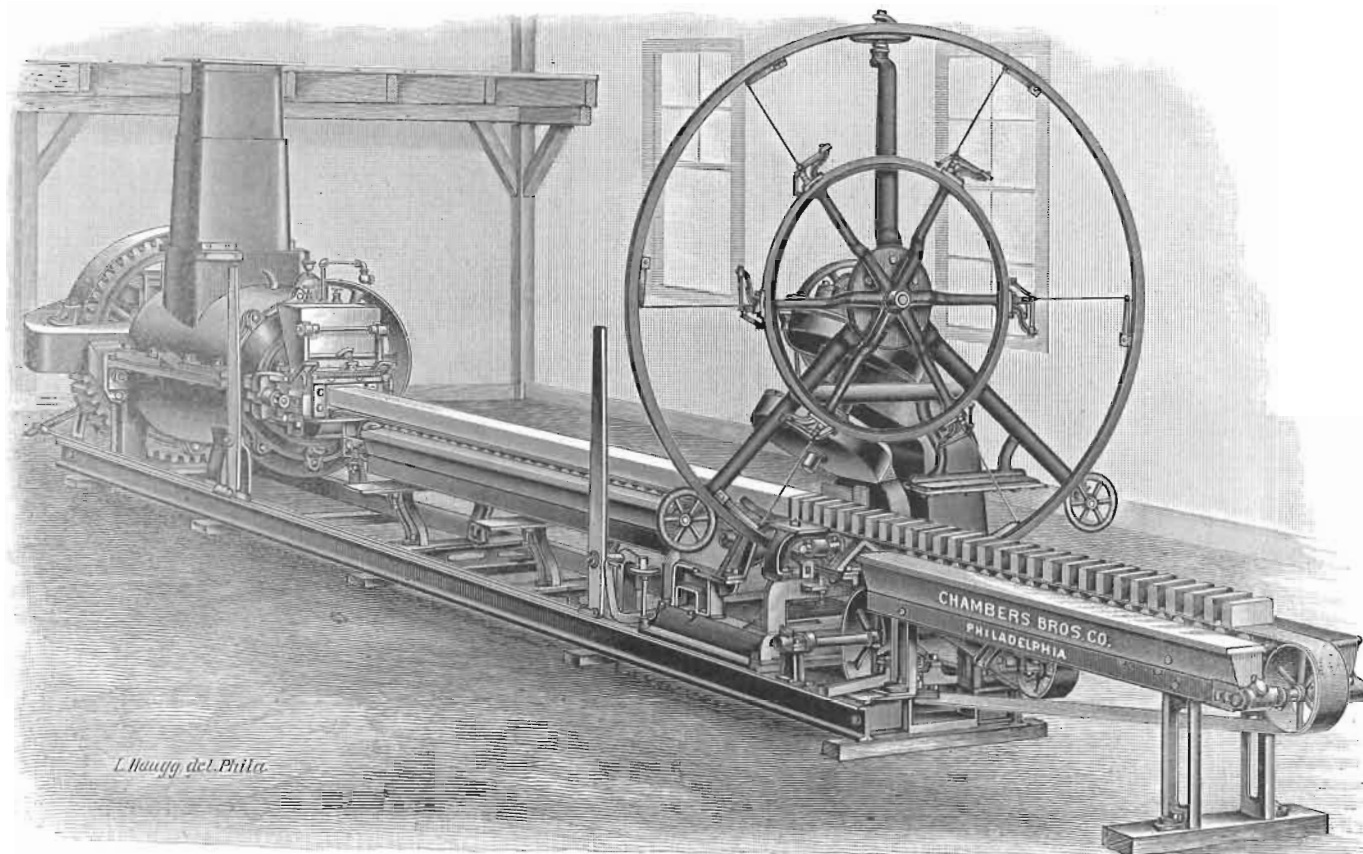

PLATE VII. Type of the Automatic Rotary Side Cutter, Horizontal Type of Stiff Mud Brick Machine and Automatic Sander.

upwards brick per hour and requiring from twenty horse power upwards. Both the capacity and the horse power necessarily vary considerably, depending on the character of the clay used, so only round numbers can be given.

Cutting Tables: There are several types of cutting tables, some of which are illustrated in the accompanying cuts. The cutting device may be either hand or automatic. The cutting is done by wires which are tightly drawn from projecting parts of a metal frame. This frame may be parallel to the moving bar of clay and consist of strips between which any number up to a dozen wires are drawn the desired thickness of the bricks apart. The cutter is operated by hand by pushing the frame laterally, thus carrying the wires through the clay. By mechanical devices it can also be operated automatically. By variations in construction this type of cutter may cut the clay by direct lateral movement of the wires, or by a lateral, partially rotary-downward motion.

The wires may be supported between large pinions which drive them through the clay as the pinions revolve. The rotary cutter is a style in which the cutting wires are drawn radially from the center of a wheel which rotates in a plane at right angles to the direction of movement of the bar. In the types thus far mentioned, the wires cut from the side. As the bar of clay is in constant motion, provision is made to carry the cutter with the bar while the wires are passing through the bar. Without such an arrangement, the brick would of course not be square. When the wires have passed through the clay, the carrier moves back to its former position. All the foregoing are applicable for both end and side cut brick.

Constructed on a somewhat different principle are those cutters or "headers" which rotate in the direction of movement of the clay. They are built as a vertical reel to the extremities of the arms of which the cutting wires are attached. The reel is

caused to rotate by the movement of the bar of clay and by means of guides on the moving belt which supports the bar, the wires are held squarely in their descent through the column of clay. The number of arms and of cutting wires on a reel varies from over forty, where side cut brick are to be made, to six or seven for cutting hollow block, drain tile and end cut brick. With the greater number of arms, this style of cutter of necessity possesses a great many joints to be kept tight and in

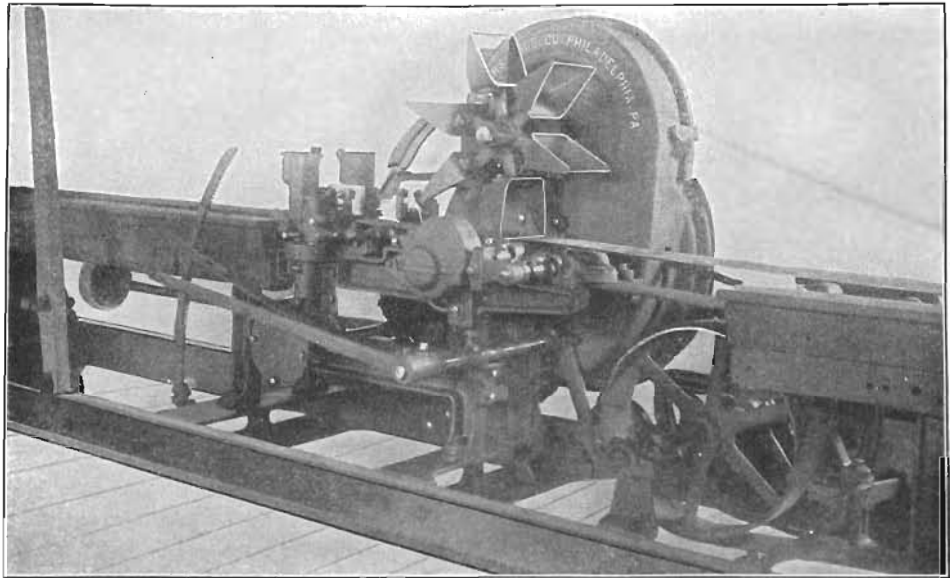

FIG. 20. The Automatic Indenting Brick Cutter.

repair, and the cutter will give satisfaction in the degree to which constant care is exercised in its operation.

The wires are the most troublesome part of the cutting mechanism. It is necessary that they shall be as small as possible with the requisite strength, in order to lessen friction and make a smooth cut. Any obstruction, therefore, met by the wires in the column of clay, as pebbles, roots or hard lumps of clay, is apt to break them. As precautions to avoid the breaking of

wires, means are provided, by regulating screws or otherwise, for adjusting the wires to any degree of tension desired and for easily replacing broken wires. In some cutters the wires are held tight by springs which allow of some adjustment to the resistance which the wires meet in passing through the clay. Automatic wire cleaners are provided for some cutters.

The requirements which a brick cutter must fulfil are several. The wires must make a smooth and square cut brick. That is, to accomplish the latter, the cutting must be done at right angles to the length of the bar of clay. With a continuously moving column of clay this necessitates the reciprocal movement of the cutter while the wires are cutting the clay. The movement of the cutter should be so connected with the movement of the clay that a varying velocity of the latter will communicate a similar change in the movement of the cutting wires. The cut should be made in such a direction that the edges of each brick will be left as smooth and free from raggedness as possible. The most advantageous direction of movement of the wires in any instance will be mainly determined by the construction of the cutting table. If not directly downward, a motion of the wires containing a downward component has been found to be most satisfactory, as the clay is most firmly supported from below and ruffled edges are least apt to be produced.

After the brick are cut, they are either delivered at one side of the table on a pallet which can be moved horizontally beneath the bar of clay as each cut is made, or they may pass from the cutting table to an off-bearing belt; the latter having a velocity greater than that of the moving bar, the brick are separated as they leave the cutter convenient distances for handling to the cars. The side delivery table is used mainly with hand operated cutters or with those that are semi-automatic, being thrown into and out of action by a clutch under the control of the operator. The off-bearing belt is a common accompaniment to the auto-

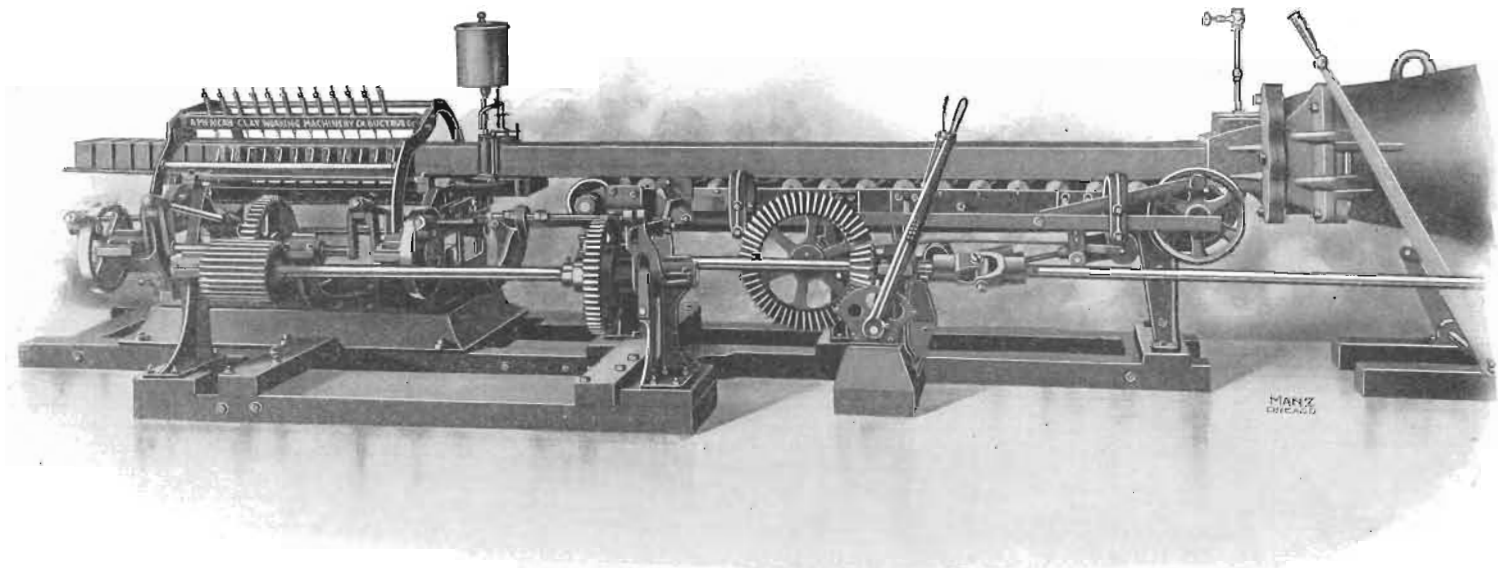

PLATE VIII. Automatic Oscillating Reciprocal Down Cut Table.

matic cutter where the auger machine is of large capacity and run continuously. From this belt the brick may be removed on one or both sides to the cars.

The cutting platform over which the column of clay moves when the cutter is in action, is smoothly polished to prevent friction. If the clay gives trouble by sticking, lubricating rollers are provided beneath and at the sides of the clay bar. These rollers are held in contact with the clay by springs and are kept

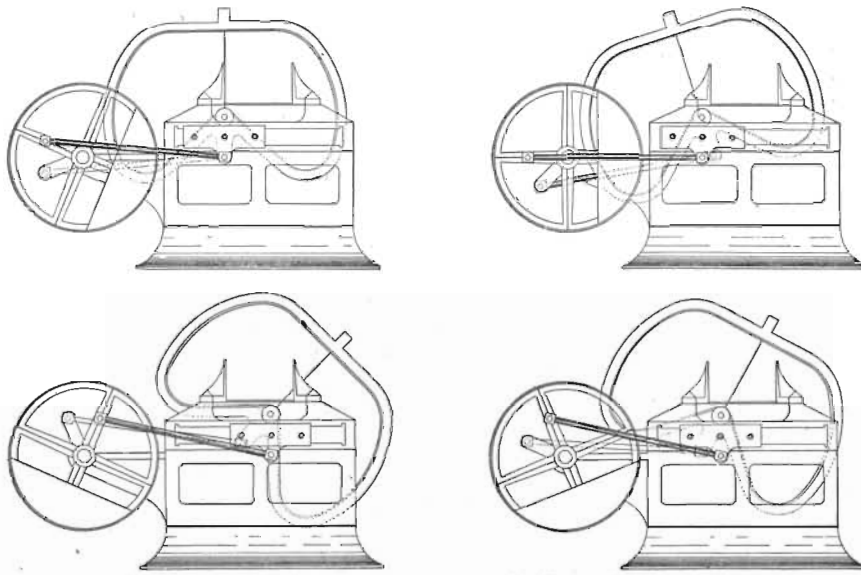

FIG. 21. Sectional Views of Reciprocating Oscillating Side Cut Table.

continually moistened with an oil lubricant from a small reservoir conveniently situated above the machine.

Of the several styles of cutting tables on the market, there is always the question of which is the most suitable for a given clay. This is an inquiry that confronts every brickmaker in selecting an equipment for his plant. In many cases the question is not settled until two or more different types of cutters, representing the expenditure of a few thousand dollars, have been purchased. It is then often realized that the last purchased

gives little better satisfaction than the first, which may have been discarded for something "new." It is not an uncommon thing on brick yards throughout the state to find them equipped with cutting tables in duplicate, and sometimes triplicate, in number and style, only one of which is in use at a time. The others are either laid by indefinitely or are held ready for substitution in case of breakage or in case some variation in the clay appears to require a change. Very often one cutter is used for end and another for side cut brick.

While in the case of brick machines, the machine must be fitted to the clay to be used, this is much less often true with cutting tables. The cutting table is an accompaniment to the stiff mud machine only, and ordinarily any clay that will work in a stiff mud machine can be cut into bricks by the same kind of cutter. That is, if the cutter is once adjusted to run with a certain auger machine, it will be found that the same cutter will make brick from any clay that will successfully work in that machine. It is seldom advisable, therefore, to change cutting tables because of some slight improvement that may be claimed for another style. The latter will likewise need adjustment to the brick machine before it can be used, and it is the experience of many that it will quite frequently give no better satisfaction than the old one. Money tied up in cutting tables that are allowed to lie unused is an investment that can yield nothing but negative returns.

Repressing: The repressing of brick made by the stiff mud process has become a common practice among paving brick manufacturers principally. Building brick made by this same process or by the soft mud methods are also repressed to some extent, although not to such an extent as prior to the recently extended use of the dry press machine.

The brick may be taken directly from the cutting table and repressed, or they may be closely hacked and allowed to par-

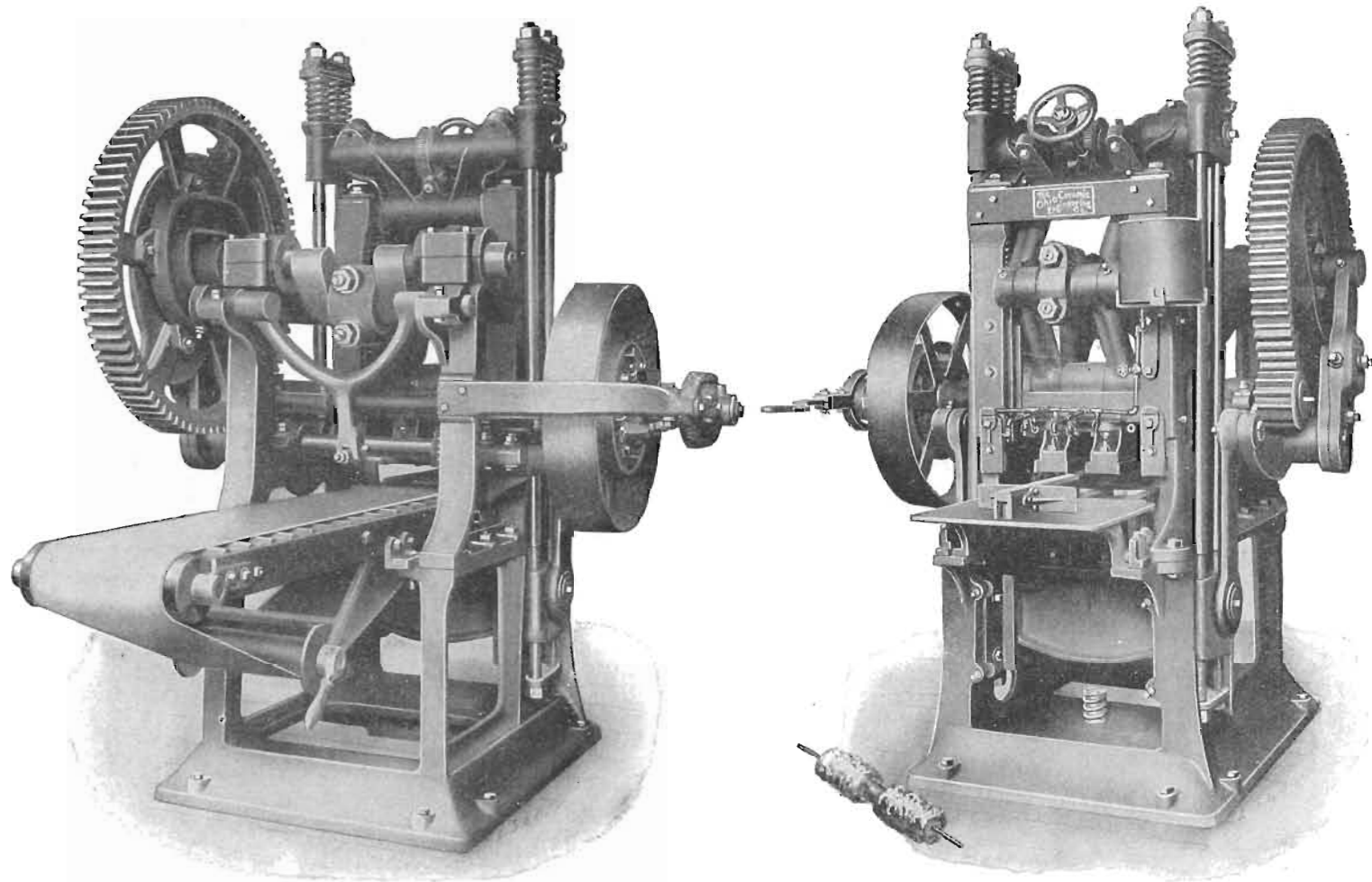

PLATE IX.
The Richardson repress, front and back views.

tially dry until they are of the proper consistency for repressing. It is of course always necessary to allow soft mud brick to dry before placing in the repress.

Brick represses are operated by power or by hand. There are several types of these machines on the market, but the principles involved in the construction of each are essentially the same. The term repressing signifies the process of subjecting the brick to a second pressure, or to pressing again after the brick have been formed. The machine for this purpose consists of a mold into which the brick are placed, and where they are subjected to heavy pressure. In the latest improved types the pressure is applied gradually and regularly by a plunger from above or by plungers from both above and below. The brick are delivered to the repress on a table or moving belt from which they are automatically charged into the molds. Accuracy in design is quite necessary in order that the brick will be placed squarely in the molds with each revolution of the plungers. The brick must also fit and fill the mold as perfectly as possible. Each size of brick thus requires a separate mold. The mold is in some machines stationary and the pressing is done by plungers from the top or bottom, or from both moving towards each other. In some, one plunger is stationary while the other moves against this, carrying the mold with it. Pressure is exerted by means of a cam, crank or toggle joint. Movement is imparted to these by levers if operated by hand and by clutch-pulleys and heavy gearing if other power is used. In the most substantially built represses, pressures as high as 45,000 pounds per square inch can be exerted on a brick. The pressure can be regulated to any desired strength. It has been found by practice that a better product results in most instances if two maximum pressures are given with a partial relief of pressure between. In case a brick which is a little too thick comes to the repress, relief for the mold and pressing plungers is provided by small open-

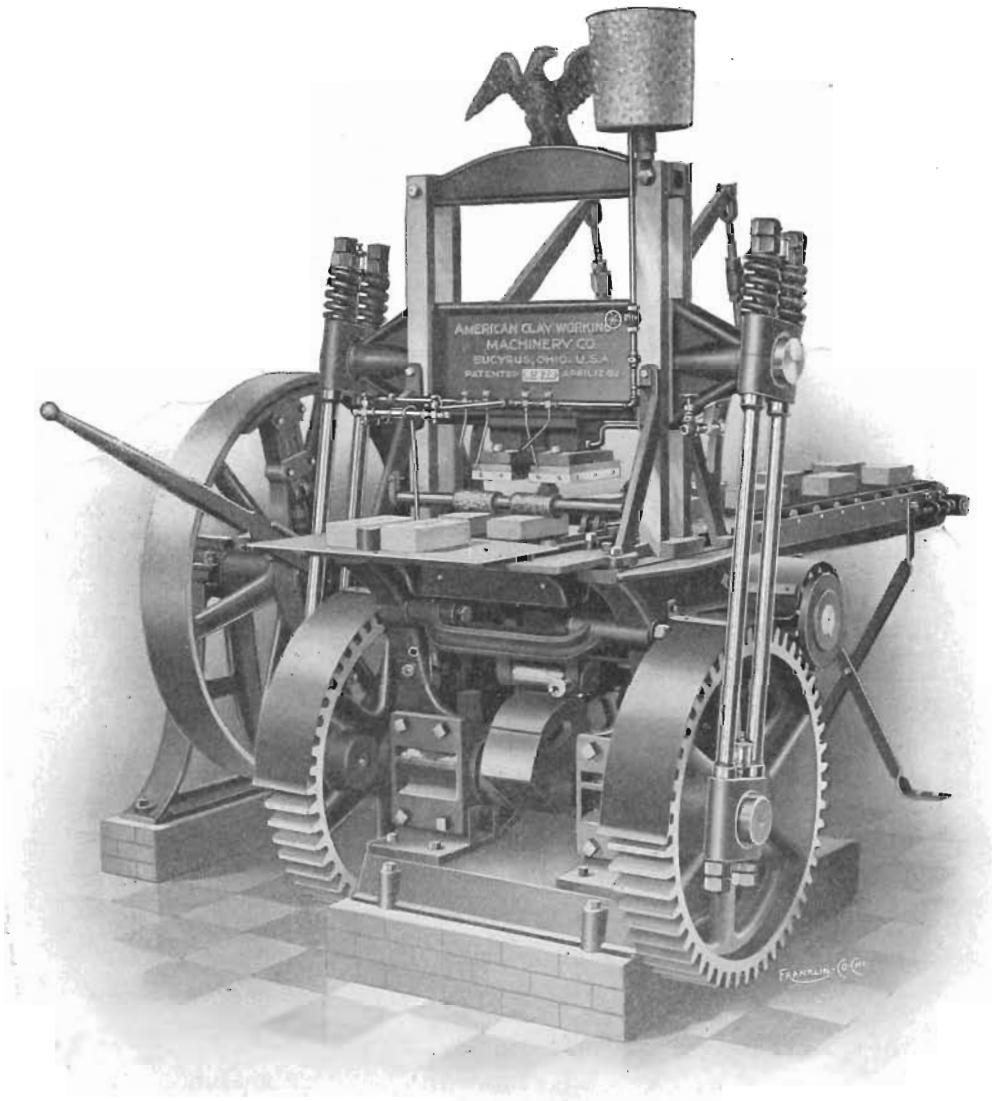

PLATE X. The Eagle Double Die Brick Re-Press. Front View.

ings in either mold or die plates so that the surplus clay is forced out; or by the use of strong springs which yield when the pressure reaches any certain limit. The latter mode of relief is often preferred to the former because of the blemishes left on the brick by the vent holes. Where springs are used, however, the brick are not reduced to a uniform size, while this is accomplished by the die plate vents. The power required to run a two-mold repress is from one to two horse power. The capacity varies from 1,000 to 3,000 standard-sized brick per hour.

The object of repressing stiff mud brick is three-fold: to improve the form and to imprint any desired design upon them; to give a smoother surface; to produce a denser and stronger brick.

For building brick, the first is usually the prime object sought in repressing. By repressing, the outlines of the brick may be modified so as to change an angular, rough-edged brick to one with symmetrically rounded or sharply angular edges as is desired. By the use of special designs on the die plates any of the ornate forms may be produced. The designs may be simple, as some geometrical figure, or may be of more artistic and complicated character. For paving brick, the appearance of the product is not an important feature. In the repress, however, it is possible to obtain a symmetry and fullness of outline for each brick which are believed to both facilitate handling and laying in a pavement, and to add to its durability.

In the manufacture of sidewalk blocks, the repress is in common use. The clay is run from an auger machine in a column of correct proportions for cutting into the desired sized blocks. As with brick, the blocks are placed in the repress, where their form is improved and some design, in many instances the firm name, is impressed or expressed upon them.

The pressure which the brick are given, slipping in and out of the mold, in which some lubricant is frequently used, renders

the surfaces smooth and polished and especially is this improvement noticeable on the faces that have been made by the wires of the cutter. The brick are thus given a tough exterior or "skin" which adds to their ability to withstand disintegrating influences, which, especially in the case of building brick that are not hard burned, is an important feature.

Regarding the effect of repressing on the compactness, resistance and strength of brick, there has been much speculation. It is more important to develop these properties in paving than in building brick, and this is the principal object in repressing the former.

In the operation of the repress, the brick can not be made to fit perfectly tight in the mold. There is always more or less space for the clay to expand laterally as pressure is brought to bear from above and below. The compression of the clay will cause the particles to come into closer contact and the brick will be decreased in thickness; but at the same time a certain amount of flow will take place to fill the mold and the brick will increase in width and length. If the one extreme be considered, where the brick fits the mold perfectly tight, and therefore no flow can occur when pressure is applied, it is seen that practically no change in structure can be brought about, only a change in the compactness of the brick. Such a brick still possesses the original structure given to it by the brick machine, but has gained in the matter of form, smoothness of surface and compactness. As an intermediate stage, suppose the brick to fit into the mold rather loosely. This limited amount of space will allow of a corresponding limited expansion. Instead of the decrease in thickness being taken up entirely by packing together of the clay particles, such decrease will be accompanied by an increase in the length of the brick to the capacity of the mold. The flow of the clay which must take place under these circumstances tends to change and to destroy the former structure of

the brick. A brick thus repressed has its old structure only partially broken down and possesses neither its original machine structure nor any new one which may be developed in the repress. At the other extreme, or where the brick is placed in a mold which it fits very loosely, the clay when subjected to pressure has ample opportunity to flow and the original structure is entirely destroyed.* Any structure which a brick repressed under these conditions may have will be one developed in the repress. In this instance the only function that the auger or soft mud machine has served is to furnish the clay to the repress in convenient shape and in proper amounts to make brick of constant size.

In the application of the repress to any class of brick made of any certain type of clay, the questions to be decided are those which relate to the above conditions. It has been found that clays do not all respond to repressing in a similar manner. With the same pressure, and that near the maximum attainable, some clays will give a more durable product if treated in the repress, as outlined above, so that no rearrangement of structure is possible; others are improved if subjected to conditions such that the old structure is entirely broken down. It is rarely the case that the resistance of a brick is not injured by repressing where only sufficient flow of the clay is permitted to modify the original structure but not enough to reconstruct or build a new one.

“Comparison of the Wearing Qualities of Plain vs. Repressed Brick”† was made the subject of investigation by the National Brick Manufacturers’ association in 1897 and 1898. After a fairly complete series of experiments with different types of clays and with both side and end cut brick, it was found that with the majority of clays repressing is a detriment to the wearing qualities of the brick. This was not found to be true in all

* An even more complete breaking down may be obtained, by way of experiment, by placing the brick in the mold so the pressing plunger will compress it edgewise. In this case, the original form of the brick is completely obliterated and it is entirely reconstructed.

† Report of the N. B. M. A. Committee on Technical Investigation, p. 67.

cases, but the recommendation was made that its truth be assumed unless for a given product it were proven that repressing actually improved the quality.

Parallel to the above investigation, experiments were made to ascertain the "Influence of Flow in the Repress Die."* From the same clays used above, bricks were repressed according to the conditions outlined on a preceding page, viz., in a die where practically no flow was possible; where a limited amount of flow could take place, and with the brick on edge so that all traces of original structure was broken up.

The results of both the above sets of tests were summed up in the following conclusions: "Makers of paving brick should assume that their plain wire-cut brick are superior to the repressed brick until they have proven, by careful comparison under identical tests, that the assumption does not hold good in their case.

"If repressing is necessary to meet market conditions, the maker should perform the operation so as to cause a radical breaking up of the auger machine structure, and the production of a new and characteristic structure due to repressing. If this is done, the probabilities are that no falling off in quality will occur, and actual gain in strength may frequently result."

Dry Press: The manufacture of brick from dry or partially dry clay is a process which has come into extended use only in comparatively recent years. At the present time, the dry clay process represents perhaps the cheapest method of producing brick, which are at the same time of a higher grade, in both finish and durability, than those produced by any other process. The initial expense in equipping a dry press plant is, however, somewhat above the ordinary.

The principal points in the preparation of the clay for this line of manufacture have been mentioned under that head. To

*Report of the N. B. M. A. Committee on Technical Investigation, p. 92.

render the clay in the best condition, a period of weathering, if the clay is a somewhat indurated shale, or of storage in the dampened state, if it is one that will easily become plastic with water, will be found advantageous. The weathering or storage allows the moisture which is in the clay, or that which is added to it, to thoroughly permeate the mass, thus reducing all to the same consistency. To work best in the dry press machine, the clay must not be plastic but should be of such a degree of damp-

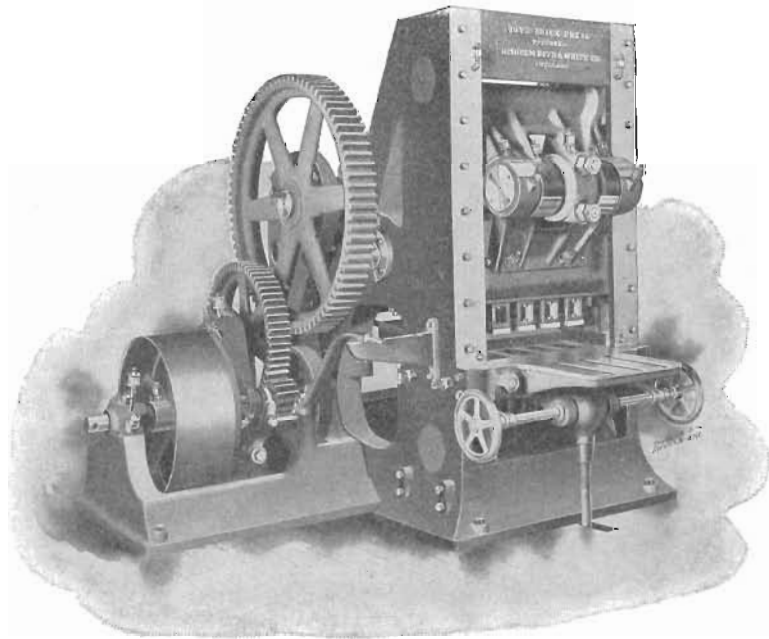

FIG. 22. Modern four-mold dry press.

ness that when firmly pressed in the hand it will barely maintain the form given to it. The amount of water that clays contain that are worked by this process ranges from five to fifteen per cent. These proportions depend on the character of the clay, the finer, more plastic varieties requiring the larger percentages. After thorough granulation in some pulverizing apparatus, the clay is ready to go to the press. The dry press machine consists in its essentials of parts similar in construction to the

brick repress. The molds vary in number from two to six. The pressing mechanism consists of plungers which exert pressure from both above and below when clay is in the mold. The plungers are operated by cams or toggle-joints which are supported by massive steel framework to give the requisite strength. The clay comes from a hopper or storage bin through canvas ducts into a small feed-box from which it passes into a charger. The charger is made of a capacity to hold clay for one brick and with each raising and lowering of the press plungers, feeds this amount of clay into each of the molds, being refilled as it comes to rest beneath the feed box, while the brick are being pressed. In all recently constructed dry press machines, two and frequently three, pressures are given each brick. In some machines all are of maximum amount, while in others two maximum pressures and an intermediate lesser pressure are given. When clay is pressed in the mold, air is enclosed in its pores which, when but a single pressure is given, will quite often by its expansion when the pressure is relieved, crack or burst the brick. It is to remove this danger that the pressure is partially released, thus allowing the air to escape through vents in the die provided for the purpose. The final pressure compacts the clay to its maximum density. After the molds are charged and the pressure has been applied, the brick are carried by the movement of the lower plunger to the level of the top of the mold, where they are pushed forward on a delivery table by the incoming charger. In the most improved types, the molds are deep and the maximum pressure is given at the bottom of the mold which gives the larger distance of travel for the brick as they are delivered, thus smoothing and polishing their surfaces; and, as the lower plunger carries the brick upwards the plunger above maintains its position on the upper surface, which protects the corners and angles and gives a firmness to the brick. As the charger advances with its supply of clay, the green brick are pushed ahead

of it from between the dies and the molds are filled. In some, the bottom plunger retains its position level with the top of the mold until the charge of clay is directly over the mold, when it lowers; in others, the lower plunger descends as soon as the formed brick is removed and the fresh clay is allowed to drop from the charger into the open mold. Both the charger and the molds are steam heated to prevent adhesion of the clay.

Aside from the ordinary rectangular shape of the common brick, special shapes may be produced by molds which are substituted in the dry press machine. Shapes, face and edge designs are produced by special molds and dies. From the machine the brick are handled separately or by pallets to dry cars or are sent directly to the kilns. It is claimed that the frame and the working parts of a standard make of dry press are capable of enduring a pressure of four hundred tons on each brick. Such a pressure is never necessary in the manufacture of brick, more than one hundred tons on each brick seldom being required. The power to operate the press is usually steam supplied from the power plant. In the case of the hydraulic press, the pressure is exerted by hydraulic rams acting from above and below as do the plungers in the other class of machines. The capacity of a six-mold dry press machine is 30,000 bricks per day. A press with four molds will make 20,000 per day of ten hours.

MANUFACTURE OF DRAIN TILE, HOLLOW BRICK AND BLOCKS.

The clays used for the manufacture of these wares are given the same preparation as when made into brick with the auger machine. They are pugged to the same plasticity and put through the same machine, the desired die being substituted to form a hollow column in place of the brick die which gives a solid bar of clay. Most common clays can be used for tile, but in the case of hollow brick and blocks other requirements must be met than those exacted of drain tile. A clay which will run

smoothly from a circular die may give trouble in a die with sharp angles. The clay for angular blocks, which are often cut up into two or more compartments by partitions, must be more plastic and slippery to give satisfaction in the auger machine. Tile are subjected to the disintegrating effects of frost and soil waters, but have essentially no weight to bear when in place. The hollow brick and blocks when used in construction must bear a greater or less weight, along with meeting similar conditions to which the drain tile are subject. Aside from plasticity, therefore, it is necessary to employ for the manufacture of the last two classes of ware a clay which when burned makes a firm product, sufficiently strong to be used in building construction in place of brick.

The clay is run from the auger machine upon a cutting table especially designed for the ware made. If hollow brick or block are made the brick cutters may be used with modification to accommodate the different sizes of column. In most instances, however, tables of special design are made use of which are accompanied with dumping attachments, so the block or tile is delivered upright and in convenient position for removal without injury. The cutting mechanism is similar in principle and operation to the brick cutters already described. They are built in both patterns, the side-down-cut and the rotary.

The use of hollow blocks to replace the solid brick is becoming rather common in Iowa. The advantages claimed for the hollow ware are several. While they do not possess as great ultimate crushing strength as the solid brick, blocks can be economically produced which are sufficiently strong to insure a large factor of safety in any common building construction with from one-third to one-half the clay required in the solid ware to occupy the same space. This decrease in weight, with retention of the necessary strength, not only saves clay but lessens the expense of transportation very materially. Walls built of hollow blocks

are fully as protective against dampness and temperature as brick walls and by many users are pronounced much superior to the latter in every way. Decoration of the blocks has not been practiced to any extent in the state, but very desirable terra cotta effects are inexpensively produced in other places where this class of ware has been developed to a higher degree of perfection.*

MANUFACTURE OF SEWER PIPE.

Sewer pipe is made in a press especially designed for this class of ware. The press consists of two cylinders connected with a continuous piston. The cylinders are placed one above the other, the upper being the steam and the lower the clay cylinder. The ratio of the size of these two cylinders varies from 1:2 to 1:3. The piston is propelled by the admission of steam to the upper cylinder, giving it a downward movement which presses the clay through a die at the bottom of the lower cylinder. The action is thus intermittent, the piston receding when it has reached its length of stroke and a supply of clay is needed.

The clay previously prepared and in the plastic condition is brought to the press on a moving belt. Each time the piston recedes the cylinder is filled with clay by throwing this belt into motion. The die which forms the pipe consists of a central cone and an outer die or bell. The space between the cone and bell determines the thickness of the wall of the pipe. By changing these the various sizes of sewer pipe are made. It has been found of advantage to have the issue, or the distance through which the clay must travel between the dies compressed to its minimum thickness, quite long. Mr. J. E. Minter† recommends an issue of not less than three inches for dies smaller than eight inches and not below four inches for dies over eight inches in diameter. The basis for this recommendation is that where the

* A treatise on the manufacture and use of hollow building blocks by E. G. Durant is issued by the American Clay-working Machinery Co.
† Brick, Vol. XVIII, No. 1, p. 48.

issue is short, blebs of air imprisoned in the clay will remain and are apt to form blisters on the pipes, while with a long issue the air will back upwards through the loose clay and escape in the direction of least resistance rather than remain in the clay.

Beneath the die is the pipe table which receives the pipe as it issues from the cylinder. The table is supported by a vertical rod which is kept in perfect alignment with the center of the cylinder. The table is raised and lowered by weights which may be so adjusted as to counterbalance, when the table will easily move up or down or stand at any position; or, as is usual, when pipe are being made, so adjusted as to offer resistance to the emerging pipe. The pipe is said to run more smoothly than where such resistance is absent or but very slight. After the pipe is forced out the desired length it is cut by hand by means of a wire or automatically by means of a power cutter which is thrown in and out of operation at will. The power cutter consists of a knife edge in the lower part of the cylinder which is thrust out and given a circular motion that severs the pipe when the cutting mechanism is thrown into gear. The length of stroke of the piston and therefore the maximum length of pipe is about four feet. The size of the pipes ranges from three or four inches to three feet in diameter.

MANUFACTURE OF POTTERY.

The pottery interests of the state are limited to the manufacture of only the commoner and less expensive classes of stone and earthenware. In the stoneware line, jugs and jars constitute the large proportion of the output. The various sizes of flower pots made from both red and light burning clays, are the principal earthenware products. This apparent paucity of pottery products can not be said to be due to the lack of proper raw materials, for the present investigation has shown the existence of clays suitable for making many of the higher and costlier grades of pottery.

The process of forming the pieces of ware may be divided into: that done by hand or turning, machine manipulation or jollying and pressing. Preliminary to forming the ware by any of these methods, the clay which has been properly ground and rendered plastic, is wedged. Wedging consists in repeatedly cutting a piece of clay of convenient size to handle, with a small wire which is drawn taut above the kneading table. After each cut the two parts are brought forcibly together and the cutting operation repeated. By this means air blebs are eliminated from the clay, and it is said, a desirable grain given to the clay which it would otherwise lack. Clay is then taken in sufficient amount for the piece of ware to be made and placed on a horizontally rotating disc. Here it is shaped with the hands and turned up to the required size and outline. The surface of the clay is intermittently moistened with a wet sponge so it will run smoothly and not trouble by sticking or tearing as it is drawn into its permanent form. When the piece is complete, it is detached from the disc by means of a wire or thin blade and placed to dry. Only those pieces of pottery can be made in this way which have circular cross sections and fairly thick walls, as in the turning they must rotate round a central axis and possess sufficient rigidity to take and maintain shapes as high as three feet or more in such wares as churns or large jars. Such forms may taper in one or two directions. The first difficulty of the beginner is in "centering" the piece of clay. After this becomes substantially automatic, practice with the various shapes and sizes is required to become expert. A high degree of dexterity is necessary, however, to form ware of true proportions and uniform thickness, an accomplishment which is usually attained only through long practice. This is the practice of the early potter and is gradually giving way to the use of the jolly or jig.

The potter's jolly or jig consists essentially of two parts, a horizontally rotating disc furnished with a hollow metal head

for receiving the plaster of Paris molds in which the ware is made; and a pull-down arm provided with a "template" for shaping the interior of the piece of ware. The motion of the rotating head is not positive but is usually imparted by friction between a pulley on the vertical shaft, which is faced with rubber, and a vertically rotating disc. The speed of rotation is thus regulated by a foot lever which adjusts the amount of friction between these two parts.

The molds are made of plaster of Paris with the interior the desired shape of the outside of the ware. They are made of a size to fit the head of the machine and of considerable thickness so that when set into the head their weight causes them to whirl with it. The requisite amount of clay is placed in the whirling mold and first roughly shaped with the hands. The "pull-down" bearing the arm for accurately shaping the interior is lowered and the clay is evenly distributed in the mold. On the improved jollies the pull-down lever is adjustable so that any number of pieces of exactly similar outline and thickness may be produced, and of such weight and counter-balance that the shaping of the clay is accomplished with the least exertion on the part of the operator. Special adjustments are also provided for jollying bulged or bellied ware. In the case of any ware in which the sides are other than vertical or regularly tapering, the containing molds are made in two or more sections which are separated when the ware is removed. Where the opening is quite small, as in jugs, each article is made in two pieces and these pieces cemented together by means of a thick slip of clay and water. The jolly is used in the manufacture of jars, jugs and the larger flower pots.

The smaller sizes of flower pots are made on a pressing machine especially designed for the work. By the substitution of molds, sizes ranging from one and three-fourths to six or seven inches in diameter are made by machine. The plastic clay is put

into a small plunger machine from which it is forced in one or more circular columns. The columns are cut by wires so spaced as to make small cylinders each containing the correct amount of clay for one pot of a given size. The flower pot machine consists of a mold set in a whirling disc. Above the mold is a plunger having the exact shape and size of the interior of the pot. The cylindrical blocks of clay are placed in the mold and the latter elevated by means of a foot lever until it fits over the plunger from above, which presses the clay firmly into the mold. The bottom of the mold is the top of a lower plunger which, as the mold is again lowered, pushes up and out the finished pot. The capacity of such a machine depends upon the agility of the operator.

STONEWARE GLAZING.

Most stoneware articles are covered with a glaze. The glazes are made of ingredients which when heated to the burning temperature of the ware will fuse and attach permanently to the surface of the ware. The process of glazing is literally the formation of a thin surface layer of glass for the purpose of decoration or protection of the ware on which it is placed. In order to serve one or both of these functions, the glaze must run evenly when melted and neither craze nor shiver after the ware comes from the kiln. Glazes must be uniform in composition and on the rough grades of stoneware, fuse at a fairly low temperature. If a color is to be imparted by means of a glaze, the coloring matter must be readily and uniformly absorbed by the glaze ingredients in fusion.

The object in glazing stoneware is primarily protection. The body of the ware is seldom vitrified and the glaze, being thoroughly vitreous and non-porous, renders possible the use of stoneware articles for containing liquids. Stoneware glazes are invariably colored, which not only improves the appearance of

the natural clay but also helps to obscure and correct any small defect in the body of the ware.

There are three kinds of glazes made use of, viz., salt, slip and Bristol glazes.

Salt Glazing: Salt glazing is not practiced to any extent at present in stoneware manufacture, but it is the only glaze employed in the sewer pipe industry. It represents the simplest and crudest manner of applying a glaze to any ware. Common salt is shoveled into the fire boxes when the temperature has reached the maximum used in the burn. The intense heat in the presence of the kiln gases and water vapor (the salt is very commonly moistened before being applied) dissociates the sodium chloride (NaCl) and the following combination with water takes place:



The resulting free hydrochloric acid is expelled and the soda attacks the alumina, silica and iron of the clay forming the glaze. Successful salt glazing necessitates a temperature above cone 1 where the clay will stand it, several cones above this will increase the likelihood of securing a good glaze. Iron oxid is found to be a necessary ingredient in the glaze, giving the brown and greenish colors and increasing the fusibility. More elevated temperatures are required for non-ferruginous clays and clays which are impregnated with whitewash, the latter being mainly sulfate of lime.

The composition of salt glazes is not definitely known, nor is the character of the clays best adapted to this method of glazing fully known. The most conclusive information in these regards are the results of experiments made by L. E. Barringer at the Ohio State University.* Mr. Barringer quotes the analysis of a salt glaze and of a clay upon which it is successfully used.

*Transactions Am. Ceramic Society, Vol. 1V, p. 211.

| | GLAZE. | CLAY. |
|--------------------------------------|---------|--------|
| SiO ₂ | 55.340 | 63.110 |
| Al ₂ O ₃ | 21.340 | 23.300 |
| Fe ₂ O ₃ | 2.640 | 2.235 |
| CaO | 3.500 | .725 |
| MgO | .040 | .970 |
| Na ₂ O | 17.210 | .490 |
| K ₂ O | .080 | .930 |
| SO ₃ | | .240 |
| H ₂ O | | 7.810 |
| Total | 100.285 | 99.810 |

The conclusions drawn from a series of tests with the above clay made by varying the relation of the silica and alumina and the size of the grain of the sand are given in full:

“1. A clay may be either too aluminous or too siliceous to be successfully salt-glazed.

“2. Clays containing alumina and silica between the molecular ratio of 1.00 alumina to 4.6 of silica; 1.00 alumina to 12.5 of silica, are capable of receiving a salt-glaze if the process is properly carried out. If these limits are exceeded the material is not suited for salt-glazed ware.

“3. While it is possible to salt-glaze clays containing alumina and silica in the above ratios, the requirements of the process of making stiff mud goods would not permit the use of such siliceous clays as those with an alumina-silica ratio of 1 to 9 or 1 to 10. That is, the practical value of a clay, as to plasticity, strength, etc., will draw narrower limits than those found in the above tests.

“4. As regards brightness, smoothness and finish of the salt glaze, it makes but little difference whether the free silica in the clay is fine or coarse.

“5. As regards color, the finer the sand the lighter the color of the glaze.”

The presence of efflorescent salts in the clay has always been considered a hindrance in salt glazing. On drying, these salts

are partly brought to the surface and there deposited as a scum. The salt must combine with the silica and alumina of the clay through this scum unless the temperature of the kiln is sufficiently high to decompose these efflorescing compounds. In the latter instance, elements may be furnished which will assist in the formation of the glaze. The commonest substance which forms whitewash on clays is calcium sulfate ($\text{CaSO}_4 + 2\text{H}_2\text{O}$). The sulfate is not decomposed until high temperatures are reached, perhaps as high as is attained in much of the salt glazing that is done. On dissociation, a thin layer of caustic lime (CaO) still coats the surface of the clay and tends to prevent the attack of the soda. When the temperature is high enough to cause the lime to enter into combination with the constituents of the clay, then the soda and the lime undoubtedly act in conjunction in the production of a glaze; and if the lime is not present in excessive amount, it adds to the brilliancy and perfection of the glaze. It will be noted in the analyses quoted that the glaze contains 3.5 per cent of lime while the clay carries but .725 of one per cent. This excess of lime in the glaze is very probably due to the efflorescence of lime salts on the outside of the clay.

Investigation of the effect of whitewash on salt glazing was also made by Barringer. No decisive results were obtained but enough was done to warrant the statement that, "up to 3 per cent of soluble salts may be present in clay without seriously interfering with salt glazing when conducted at Cone 8." Cone 8, 1310° C., represents a higher temperature than is commonly employed in burning sewer pipe and is probably fully as high as the average stoneware temperature. It is principally in the glazing of sewer pipe and paving brick that difficulty with whitewash is encountered.

In practice, the ware is burned to the desired degree and is salted a few hours before closing down. The fire holes are well

filled with fuel and the kiln is allowed to burn clear. The damper is then lowered so as to cut off a good share of the draft. The salt is fed, a shovelful or so, into each fire box. The volatilized salt passes in among the ware, which is set openly so as to give opportunity for the salt to reach as nearly the whole surface area of the pieces as possible. With the draft largely cut off, the kiln stands in a bath of salt vapor until the first salting is exhausted. It is always noticed that the kiln is perceptibly chilled during salting. The chemical reactions which occur in the decomposition of the salt and the formation of the glaze appear to be chiefly endothermic, or heat consuming. Because of this fact, a period of firing must follow each application of salt in order to regain the necessary temperature. Some have attempted to avoid this rapid cooling by the addition of resin or oil, or both, with the salt. While the idea is a correct one, this expedient has not proven very successful. On closing the damper previous to salting, the kiln becomes filled with reducing gases—partially burned fuel, hungry for oxygen. Oxygen is even taken from the iron oxide in the clay to help satisfy combustion, and the color of the ware is changed from a red to brown or black—which condition is, however, considered to be favorable to glaze formation. Little air is entering the kiln and any fuel, whether it be coal on the grates or a combustible added with the salt, will be only imperfectly burned and will therefore add little to the heat in the kiln. The work of the salt in the kiln is ascertained by drawing trial pieces. When these trials show a good glaze, no more salt is required and the kiln is closed down. It is oftentimes necessary to salt three or four, or even more times, to secure the best possible results.

It is sometimes found that although trials show a perfect glaze, when the ware is drawn the glaze is either absent or very poor. It is thought that the sulfurous gases from the fuel are sometimes active to thus destroy a good glaze. At the conclusion of

the glazing the dampers are dropped and the fire holes are usually mudded tight. The fuel still on the grates continues to slowly add to the gases in the kiln. Sulfurous acid being relatively a heavy gas and therefore less apt to find its way out through cracks in the kiln walls than the lighter ones, accumulates and the ware is soon surrounded by an atmosphere strong in SO_2 . Just what the action of the sulfur gases on the glaze is, is not known. A breaking up of the glaze by sulfate combinations with the fluxes seems most probable. This condition can be remedied only by drawing all unconsumed fuel from the grates before the fire holes are mudded up.

Slip Glazing: Slip glazing is practiced to a greater extent in stoneware manufacture than is salt glazing. The basis of the slip glaze is a naturally occurring clay. It is mixed with water to a creamy consistency and applied to the surface of the ware by dipping or spraying. The clay may be used alone for glazing or if it is too refractory for the ware or if it is desired to modify the color, fluxing or coloring oxids are added.

The slip clay which is most used among potters is mined near Albany, New York, and goes by the name of Albany Slip. The composition of this clay according to Prof. Edward Orton, Jr.,* is as follows:

| | |
|----------------------------------|-------|
| SiO_2 | 55.60 |
| Al_2O_3 | 14.80 |
| Fe_2O_3 | 5.80 |
| CaO | 5.70 |
| MgO | 2.48 |
| K_2O | 3.23 |
| N_2O | 1.07 |
| MnO | .14 |
| H_2O (Comb)..... | 5.18 |
| Moisture and carbonic acid..... | 4.94 |
| P_2O_5 | .15 |
| | ----- |
| Total..... | 99.14 |

* Report Ohio Geological Survey, Vol. VII, p. 105.

This shows a clay with over 18 per cent of fluxes and rather below the average in silica. It is unusually fine-grained and fuses to a glass at Cone 4 which makes a brilliant brown or brownish-black glaze. The molecular formula calculated from the analysis is:

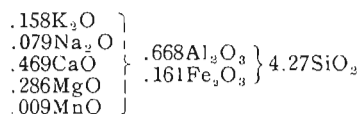

The formula indicates the essential composition of the glaze in a more graphic manner than does the analysis. It will be noted that the important fluxes are the alkalis and alkaline earths. The equivalents of ferric oxid, .16, are rather above the average for slip clays. It is the iron which imparts to the glaze its brown color.

There are several different slip clays to be had in various parts of the country. They differ in composition principally in the percentages of the fluxes relative to one another. In the formula given one flux will not replace another to any great extent without the sacrifice of desirable qualities in the glaze. None except the Albany have given complete satisfaction used alone. The others must be improved by the addition of artificial ingredients or mixture with other slip clays.

A good slip clay makes a glaze which is free from the defects common to artificial glazes. It will fit a wide range of clays and since it is a natural clay will undergo the same changes in burning, as the body on which it is placed. Artificial mixtures of exactly similar composition to the natural clays have failed to give the excellent results as to gloss or color, that are attained by the natural clay.

In Delaware county of this state a brownish-yellow surface clay has been used for slip glazing. The clay occurs as a thin stratum of subsoil on hillsides and appears to be a fine wash

from the higher slopes. Lead sulfid was added to this clay to render it sufficiently fusible.

The characteristics of a slip clay may be listed as follows: Physically, it must be exceedingly fine-grained, and free from concretionary matter; the proportion of lime and magnesia must be high, ranging from 6 to 12 per cent; the iron content should be sufficient to produce a good brown color, 5 to 7 per cent; that the clay be fusible, it must be high in alkaline minerals; the clay must have a low shrinkage in drying and must mature in burning as little above 2250° F. as possible.

The application of the glaze to the ware is accomplished by dipping the partially dried ware into a slip or slurry which is simply the clay stirred into suspension in water. The water is absorbed and the clay adheres as a film on the surface of the ware. Pieces of ware with large openings, as jars and churns, are glazed both inside and out by dipping. Those having small openings, as jugs, are glazed on the interior by forcibly pumping the slip through a nozzle or spray into the jug, the excess being emptied out. Careful handling is necessary to avoid marring the glaze in transferring to and from the drying shelves and to the kiln.

Bristol Glazing: The Bristol glaze is coming into more general use than formerly. It is most commonly made as a white or gray, opaque glaze prepared artificially by blending certain fluxes with kaolin and flint as a basis. By admixing coloring compounds nearly any desired color may be imparted to the glaze. The only glazes known to be used in the state are of the white, opaque class. They are used to replace the slip glaze either entirely or in part. Some pieces of ware are glazed on the exterior with slip and on the inside with a Bristol glaze or vice versa. The Bristol glaze must therefore be made to conform to the requirements of the slip glaze.

Cone No. 4 is used as the basis for compounding Bristol glazes. Its formula is, $\left. \begin{array}{l} .3\text{K}_2\text{O} \\ .7\text{CaO} \end{array} \right\} .5\text{Al}_2\text{O}_3, 4\text{SiO}_2$. This cone fuses at 2210° F. It is necessary to modify the relation between the elements in this compound in order to make glazes which will fit different clays; and also to add an opacifier, usually zinc oxid. Whatever changes are made, however, it is evident that the melting point cannot be altered very much. The following are formulæ of glazes in actual use:*

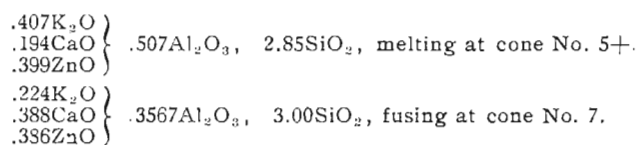

These represent about the limits of the allowable variation of the alumina. Experimentation has shown that the equivalents of silica may range between 3 and 4; of potash, between .2 and .3; lime, .2 and .4; of zinc, .3 and .5. The potash is supplied by the use of feldspar, the alumina and silica by feldspar, kaolin and flint; the lime by whiting and the zinc is used as the oxid. Zinc is sometimes replaced by tin of which it requires fewer equivalents to produce a given degree of opacity; but the latter is more expensive and is little if any improvement over the former. Because of the necessarily small proportion of clay substance in the glaze, there is little strength or bond to the mixture to hold it intact when it dries on the surface of the ware. Difficulty is thus often encountered by cracking and peeling of the glaze. As an expedient to remedy this, some soluble salt may be added to the mixture. Such salt must be one that will not injure the glaze. The purpose of the salt is to hold the glaze to the ware, which it does by forming a network of crystals between the layer of glaze material and the porous body clay. Mold washings are sometimes used in this capacity but are objectionable on account of the sulfates which they contain. Borax

* Transactions American Ceramic Society, Vol. IV, p. 73.

is rather expensive and is quite volatile. Sodium carbonate is a rapidly crystallizing salt and is to be recommended as being cheap and efficient for this purpose.

The raw materials listed above are in the larger potteries of the country intimately mixed and ground together in ball or tube mills in a dry or slip condition. As the ingredients are usually purchased in the pulverized form, however, the amount of preparation which they receive in the smaller establishments is in most cases limited to a vigorous stirring together in water by means of a plunger. The ware is then dipped into the slip by hand or the slip is sprayed by means of a nozzle precisely as slip clay glazing is done.

PROPERTIES OF CLAYS USED IN THE MANUFACTURE OF THE
FOREGOING CLASSES OF WARES.

Soft Mud Brick: In localities where clays occur of refractoriness sufficient for the manufacture of fire brick, the latter are very commonly made by the soft mud process. In Iowa no fire brick are made by this method, the output being limited practically to common building brick. The clays that are used vary in nature and composition from the soft and impure surface drift and loess to the more easily reducible grades of shale. In general, the sandier, coarser-grained clays are better worked by this method than any other. While the process of working is one that will bring out the full plasticity of the clay, plasticity is not so important a property as in clay worked by the stiff mud process, where the clay is subjected to molding forces and strain while in the moist condition. The only strains which soft mud brick must undergo in the making are those of drying. In this, of course, the greater the plasticity the less are the brick apt to suffer from drying checks. Drying conditions are regulated to suit the clay in hand.

Chemically, the clays must contain enough iron to give the burnt product a good red color. Calcareous minerals are very

commonly present and may exist in percentages as high as 10 to 12 per cent without injury, if finely divided. Concretionary lime is especially common in the drift and loess clays and when allowed to go into the brick in this condition, injury invariably results. Where concretions are not numerous, they may be removed by hand or, if finely pulverized, their deleterious effects are largely removed. The following is an average of three samples of loess clays from near Council Bluffs which are used in soft mud manufacture.

| | |
|--------------------------------------|---------------|
| SiO ₂ | 69.40 |
| Al ₂ O ₃ | 8.96 |
| Fe ₂ O ₃ | 3.03 |
| K ₂ O..... | .53 |
| Na ₂ O..... | 1.72 |
| CaO..... | 4.54 |
| MgO..... | 3.22 |
| SO ₃ | 1.37 |
| CO ₂ | 4.42 |
| Loss on ignition..... | 2.16 |
| Moisture at 100°C..... | 1.06 |
| Total..... | <u>100.10</u> |

Stiff Mud Brick: The requirements which a clay must meet to be applicable for stiff mud manufacture are somewhat more closely drawn than for clays of the preceding class. Many of the clays suitable for soft mud brick are equally well adapted for stiff mud methods. It is also to be remarked that many of those suitable for stiff mud manufacture are out of the question for soft mud brick. Stiff mud clays must possess a high degree of plasticity in order to give satisfaction in the auger machine. Since they are more plastic, shrinkage in drying is usually great and they must be strong to resist drying strains. Both common and paving brick are made of stiff mud and the requirements of clays for these two lines differ somewhat, especially their chemical composition.

Clays for common brick, if they possess the necessary plasticity, vary considerably in their composition, coming in general

within the limits mentioned for soft mud clays. Paving clays must possess such a composition as to give a good vitrified product in burning. They must not only contain a high percentage of the fluxes, but the fluxes must be those that will bring about a gradual vitrification, without the brick losing shape. Mixtures of clays are frequently employed for making vitrified wares. One of the clays is a refractory one, which, as vitrification takes place, retains the form of the ware. The others are readily fusible and serve to bind the particles of the refractory clay together into a vitreous and non-porous body. The more fusible clay, likewise, contains a considerable proportion of iron which imparts to paving brick the red, brown and other dark colors. The following tabulation indicates the limits between which the different ingredients of paving brick clays in use in Iowa range.

| | Maximum per cent. | Minimum per cent. |
|--|----------------------|----------------------|
| SiO ₂ | 74.58 | 58.56 |
| Al ₂ O ₃ | 22.33 | 8.28 |
| Fe ₂ O ₃ | 5.75 | 2.88 |
| K ₂ O | 1.15 | .29 |
| Na ₂ O | 1.79 | 1.08 |
| CaO | 3.42 | 1.55 |
| MgO | 3.47 | 1.22 |
| SO ₃ | 1.85 | 1.28 |
| CO ₂ | 2.23 | 1.73 |
| Loss on ignition | 1.07 | 5.33 |
| H ₂ O at 100° | 1.13 | .28 |

The total amount of fluxes in the clays from which these extremes were taken ranges from 10 to 18 per cent. The clays which were highest in silica carried usually the higher proportions of the fluxes and the lower quantities of alumina. Their vitrification temperatures run from 1050° C., cone 05, to 1200°, cone 3 +.

Dry Press Brick: For making pressed brick, quite a variety of clays is applicable. In the state, they are made from loess and shale clays. Plasticity is not an eminently necessary char-

acteristic of pressed brick clays. Since they are molded dry, this property is not developed in the process of manufacture. The clays are, however, moistened to an extent that is found best for a given clay. The percentage of water varies from 5 to 15 per cent. While the clay is not rendered plastic, it is desirable that a certain degree of cohesion be developed by the addition of the water. The bond is strengthened in the dry press machine. The clay which will develop the strongest bond with the least amount of water and not become sticky, meets best the requirements of the dry press process. It may be said that in general the more plastic clays conform in the greatest degree to this requirement but this cannot be laid down as a rule. Some of the less coherent loess clays are found to make excellent dry press products.

In color, dry press clays burn from a light buff to a deep red. It is often desirable to use a light burning clay in this connection as a background for a manganese or iron mottle, or speckle. In any but a very light burning clay, mottling does not show up well. The buff burning clays are usually low in iron but not necessarily so. It appears often to be, rather, a peculiar distribution of the iron mineral in the clay than any lack in quantity. Red dry press products are made from loess clays and red burning shales. The following are analyses of clays employed in the manufacture of dry press brick in the loess state.

| LOESS. | | COMPOSITION. | SHALE. | |
|--------|-------------------|------------------|--------|--------|
| DALE. | GETHMANN BROS. | | BUFF. | RED. |
| 73.69 | 67.92 | Silica | 58.68 | 58.02 |
| 9.68 | 11.76 | Alumina | 23.89 | 23.05 |
| 5.37 | 6.72 | Iron oxid | 3.83 | 3.83 |
| 1.27 | 1.87 | Potash | .84 | .90 |
| 2.72 | 1.92 | Soda | 2.19 | 2.04 |
| 1.53 | 1.63 | Lime | .96 | .30 |
| 1.01 | 1.18 | Magnesia | 1.70 | 2.04 |
| | | SO ₃ | 1.16 | .86 |
| | | CO ₂ | .26 | |
| 3.88 | 5.36 | Loss on ignition | 5.87 | 8.10 |
| .71 | 1.49 | Moisture | .79 | .96 |
| 99.85 | 99.85 | Totals | 100.17 | 100.10 |

Drain Tile and Hollow Block: Drain tile are made from any of the commoner grades of clays that are usable for making stiff mud brick. Tile are made by forcing the clay through a die so the essential physical characteristics of the clays are not different from those of stiff mud clays. It is becoming customary, however, to vitrify drain tile and to in some cases, salt glaze them, so, for these reasons good vitrifying clays are coming more into demand for this class of goods. The paving and sewer pipe clays meet the necessary requirements of the manufacture of vitrified drain tile. Many of the drain tile of the state are, nevertheless, still made from the drift and loess clays.

Hollow blocks and bricks are made from the plastic shales principally. Plasticity and drying strength, along with vitrifying qualities, are the essentials of good hollow block clay. Such wares are not usually burned to complete vitrification so that the danger of loss of shape from this cause is not especially important. The clays should not carry much lime, but the elements which will bring about incipient vitrification at ordinary kiln temperatures are necessary in order to give the finished ware the requisite strength. The chemical composition of a rep-

representative shale clay of the state from which hollow wares are made is given.

AMERICAN BRICK AND TILE COMPANY.

| | | | |
|------------------|-------|-----------------------|--------|
| Silica..... | 51.95 | Soda..... | 2.69 |
| Alumina..... | 18.34 | Sulfur trioxid..... | 2.76 |
| Ferric oxid..... | 7.56 | Loss on ignition..... | 7.39 |
| Lime..... | 4.14 | Moisture..... | .42 |
| Magnesia..... | 3.36 | | |
| Potash..... | 1.43 | Total..... | 100.04 |

Sewer Pipe: Sewer pipe wares are vitrified products and require clays high in the fluxes. The same clays are made use of that are employed in paving brick manufacture. The sewer pipe body is ordinarily a mixture of clays, one a semi-fire clay and the other a clay that will burn to the required degree of vitrification. A high percentage of iron is recommended as favorable to the best formation of the salt glaze with which the pipes are covered. A small proportion of black, top soil is sometimes included in the body mixture and is said to facilitate the formation of the glaze. Any considerable percentage of soluble salts is objectionable as the attachment of the glaze to the ware is hindered thereby.

Earthenware: Flower pots are practically the only representative of this class made in the state. These are made from white, buff and red burning clays derived from the shale beds. The essential properties of the finished pots are a high degree of porosity and a desirable color. Strength is not an important factor. Great plasticity is not essential as the pieces are formed by pressing, or jollying in molds. Any clay, therefore, which will burn to a very porous body and that possesses a decided color (whites, buffs and reds are in greatest demand, although pinks are to some extent salable) will prove a satisfactory material. The plastic stoneware clays with the addition of considerable sand make a good buff product. Whatever clay is used the required porosity is secured by light burning or the

addition of sand or both, vitrification never being allowed to take place. Because of the last fact, it is advantageous to use a clay which does not vitrify readily at any ordinary temperatures.

Stoneware: Stoneware clays belong to the semi-refractory group, so-called No. 2 fire clays. They are shale clays which contain low percentages of the fluxes and in which the iron content is not only low but distributed in that peculiar manner that gives a buff or yellowish color to the burnt clay. The percentage of fluxes must be large enough to insure partial vitrification so that the body of the ware is made substantially impermeable to liquids, and at the same time the clay must be sufficiently refractory to keep its shape in a salt-glazing heat. Much of the stoneware of today is, however, not burned to vitrification and is entirely dependent for its impermeability upon the glaze which covers its surface.

A good stoneware clay should be free from concretionary minerals, such as iron or lime, which may produce blisters on the ware that the glaze will be unable to conceal. The clay should contain less than 1.5 per cent of iron oxide. It must possess a plasticity and toughness which will enable it to stand "throwing" or hand turning. These properties depend upon the percentage of clay substance present and upon the fineness of the grain of the sand. A size of grain of from .002 to .01 of an inch for the non-plastic in stoneware clays has proved to be most suitable. Coarse sand renders the clay so absorbent that it will not hold shape well in turning.

The following is an average of ten separate analyses of stoneware clays in use in Ohio potteries.*

| | |
|---------------------|--------------|
| Clay base | 56.65 |
| Sandy matter | 37.45 |
| Fluxing matter..... | 4.44 |
| Moisture | 1.57 |
| <hr/> Total | <hr/> 100.14 |

*Ohio Geological Survey, Vol. VII, p. 95.

In these clays the fluxes represented are: Iron oxid, varying from .99 to 2.00 per cent; lime, from .41 to .60 of a per cent; magnesia, .18 to .63 of a per cent; potash, 1.26 to 3.20 per cent; soda, 0.0 to .38 of a per cent.

Drying of Clay Wares.

GENERAL CONSIDERATIONS.

The drying of clay is primarily a process of water evaporation. Evaporation of the water must be carried on under such conditions, however, as not to injure the ware dried. Economical drying, therefore, involves the problems of volatilizing the water contained in the clay and the employing of methods of doing this in the most advantageous manner. Brief consideration will be given in the following paragraphs to the physical principles on which the evaporation of water depends, and to their application to the drying of clays.

The water which clays contain consists of water of plasticity or, tempering water, and hygroscopic water.* The latter is always present in all pulverized or earthy substances which are allowed to stand in contact with the atmosphere. The amount of hygroscopic moisture in clays depends partially on the humidity of the air, but more largely on the fineness of the grain of the clays. This water can only be expelled by boiling temperatures and will be reabsorbed as soon as the clay reaches normal temperature again. Only water of plasticity is, therefore, ordinarily expelled in drying and it is to the evaporation of this water that consideration will be given.

The removal of water from clays conforms to the same physical laws as the evaporation of water in any other position. It is vaporized into space at all temperatures and turns to steam when the boiling point, 100° C., is reached. The temperature of water

*See Drying Shrinkage.

heated to boiling will remain stationary, as long as vaporization continues, until the water is all converted into steam. If, under atmospheric pressures, the temperature of water is raised rapidly to 100 degrees, ebullition or a bubbling with the violent evolution of steam takes place. The change of water to steam is accompanied by expansion† and if the steam is confined in any way, pressure is exerted. Too rapid heating of wet clay in drying will sometimes produce these conditions. The clay, from which the steam cannot escape as rapidly as it is formed, is subjected to cumulative pressure. Popping of brick thus frequently results from too rapid or overheating of clay in drying.

The transition of water to the gaseous or vapor state involves the consumption of a certain amount of heat, which does not become sensible again until condensation occurs. The absorption of heat in the formation of steam is evident from the fact that, in spite of the continual application of heat the temperature of boiling water remains at 100° C. until it is all vaporized. The heat thus disappearing is consumed in bringing about vaporization. The energy tied up in this change is called "latent" heat of water vapor. Similarly, heat is consumed in the evaporation of water at all temperatures below the boiling point. The amount of heat bound up by evaporation at lower temperatures is less than at boiling, but for any temperature the number of heat units required to evaporate a given amount of water is fixed and always the same under the same conditions. These quantities have been determined for a considerable range of temperatures. They vary from 606.5 heat units* for the conversion of one gram‡ of water to vapor at 0° C. to 537 heat units at 100° C., the boiling point of water. The latent heat of water vapor, therefore, decreases as the temperature of vapor-

† Steam has about 1,650 times the volume of the water from which it is formed.

* One heat unit = the amount of heat necessary to raise the temperature of 1 gram of water from 0 to 1° C.

‡ Multiply by 60.22 for pounds.

formation rises. The total heat necessary to bring about vaporization at any temperature includes along with the latent heat, that necessary to raise the temperature of the water to the temperature of evaporation. In the case of vaporization at boiling, the latent heat may be found in text-books on physics.

Formulae* for the derivation of these figures and tables of latent heat may be found in text-books in physics.

With the above information at hand, simple calculation will show the approximate amount of heat actually used to evaporate a given quantity of water at any definite temperature. On this as a basis, estimate can be made of the amount of fuel whose heating power is known, the combustion of which will produce the necessary heat for evaporation. The necessary fuel for drying clays whose water content is known, may thus be calculated. While the above computations will furnish accurately the heat units actually used in drying clays with known percentage of water, allowances must be made for the many sources of waste as it is obviously impossible to apply all the heat generated by the combustion of a fuel to the evaporation of water.

The continuous evaporation of water under any circumstances necessitates the presence of some medium which will remove the vapor as it forms. In a given enclosed space evaporation will progress at a given temperature only until such space is filled with vapor or, is saturated. In order that evaporation may go on continuously, therefore, either the surrounding space must be such that the saturation point cannot be reached or, a medium must be present which will constantly remove the water vapor. Atmospheric air is the important medium of transfer in all drying operations.

Water evaporates into space whether the latter is occupied by a gaseous medium or not. The gaseous elements of the air occupy atmospheric space and since it is by the movements of

* $L_v = 607.5 - 0.695T$ and
 $Q = 608.5 + 0.305T$ where L = latent heat of vapor.

these gases that water vapor is carried from the place of evaporation, the ability of the atmosphere to contain water vapor is commonly spoken of as the "capacity of the air for moisture." The capacity of a given volume of dry air to hold moisture depends upon its temperature and pressure.

When water evaporates, the resulting vapor exerts a pressure or "tension," which, combined with the pressure of the atmosphere itself determines the barometric reading at any time. The maximum value of this vapor tension is limited by the temperature. At boiling, vapor tension is equal to the pressure of the atmosphere and the vapor will therefore displace the air. Each temperature below boiling has its maximum vapor tension, beyond which point no further evaporation will take place, this being the point of saturation. These values have been determined for a considerable range of temperatures. Tables of vapor tensions may be found in text-books on physics and in meteorological publications.

It is thus possible to calculate for a known volume of air of definite temperature and under any observed barometric pressure, the greatest amount of water vapor which it will hold. It is done by the use of the following formula:

$$\text{Wt. water vapor per litre} = \frac{1.293 \cdot F \cdot .6235}{760(1 + at)} \text{ in which,}$$

1.293 = weight in grams of a litre of dry air at 0°C. and 760 mm.

.6235 = specific gravity of water vapor with air as unity.

F = tension of water vapor at t°C., the temperature of observation.

a = coefficient of expansion of air at 0°C.

760 mm. = inches of mercury column, standard barometric pressure.

This pressure is assumed as an average since actual pressures fluctuate both above and below this a considerable distance.

Practical application of this formula necessitates bringing into consideration the humidity of air before it is used in drying operations. If the air were perfectly free from water vapor, our formula would give the exact volume of air required to ac-

comply a given amount of drying at any temperature. It is a familiar fact, however, that the atmosphere always contains moisture. The quantity of moisture in the atmosphere depends upon its temperature and its opportunity for taking up vapor as, the bodies of water, lakes, rivers, etc., with which it comes in contact. As previously shown, air will absorb at a certain temperature only a limited amount of water. The higher the temperature the larger the quantity. This quantity is called the humidity of the atmosphere and the stage at which no more moisture will be taken up, is the saturation point. It is evident that if the temperature of a current of air which is saturated is lowered, condensation will occur or dew will be deposited.

The function of air in drying clays is to take up moisture. The air must be taken from the atmosphere with the moisture in it which it already happens to contain. This amount can be determined by an instrument called the hygrometer. From what has been said, it is plain that the dryer the air is to begin with, the more drying a given volume will do. And, further, that the only way to increase the drying power of air is to raise its temperature.

It is important, too, in drying clays that the air never be allowed to become saturated. Deposition of dew on clay wares is the cause of annoying difficulties, especially efflorescences where kiln or flue gases are made use of in drying. Air should, however, be filled with moisture as nearly as possible to the saturation point before it is removed from the dryer.

Where drying is carried on in the open, it is performed by air with the prevailing temperature and relative humidity. The consumption of fuel is not necessary to keep the air in motion nor to furnish heat for the evaporation of water. The needed energy comes directly from the sun and no control of the heat is had, nor of the circulation of the drying currents. In most rack or shed dryers, the heat is derived from the same source

but the circulation is usually under partial control. The latter method is usually employed for the preservation of the ware dried and, although the drying is accomplished with a smaller amount of air, it cannot be said to be more economical, from the standpoint of drying alone, because there is no expense in heating or moving the air. It is in closed dryers, where fuel is consumed in heating and moving the drying medium, that it becomes economically important to perform the drying with the smallest possible volume of air.

Clays vary a great deal in the quantity of water required for tempering. Since tempering water only is removed in the dryer, the amount which it is necessary to evaporate in drying also varies. As an average, it may be said that clays worked by the plastic process contain 22 per cent of water. For one thousand brick, this means in the neighborhood of 1,700 pounds of water to evaporate in drying. A dryer tunnel containing twelve cars each loaded with five hundred standard bricks must pass enough air to carry out over five tons of water from these brick. It thus becomes a problem for investigation to determine for a given dryer the most saving conditions under which this water can be removed.

In open air drying, the currents of air which carry away the water are warmed by the sun's heat. The specific heat of air is .2374.* A cubic meter (1.308 cu. yds.) of air weighs 1.293 kilograms at 0° C. and 760 mm. barometric pressure. The heat contents of each cubic meter of air at zero degrees is, therefore, 1.293 times .237 = .306 kilogram calories. At any higher degree, its contained heat would be, $\frac{1.293 \text{ times } .237 \text{ times } t}{1+at}$, in which, a, is the coefficient of expansion=.00367† and, t, the observed temperature. (See page 237.) If we assume an average summer heat of 16° C. (most out of door drying being done in the summer) it is seen by the formula that the heat content of a cubic meter of

* Advanced Heat. Stewart, p. 117.

† Regnault's determination. Stewart, p. 81.

air is 4.631 units which shows an average of essentially .3 heat units for each degree of temperature. These heat units are taken up as latent heat by the water in drying and as a consequence the temperature of the air is lowered. This means that for every degree the air is cooled it loses .3 units of heat. The measurable heat of water and the latent heat of water vapor formed at ordinary temperatures may be taken as 611 heat units, i. e., to evaporate one kilogram of water at 16° C. uses 611 heat units; .3 units, therefore, $\left(\frac{.3 \text{ times } 1000 \text{ gms.}}{611}\right)$ will evaporate at this temperature only .491 of a gram.

We have already assumed an average of 1,700 pounds (772+ kgms.) of water per thousand brick. To evaporate 772 kilograms of water requires, 611 times 772=471,692 heat units. To dry a thousand brick, therefore, with air at ordinary temperatures requires that 1,572,361 (772,00÷.491) cubic meters of air lower one degree in temperature to furnish the required amount of energy. Or, where the air is somewhat confined as in drying sheds so that it may remain in contact with the wet ware for some time, the same evaporative power would be possessed by one-half the volume lowering two degrees, or by one-tenth lowering ten degrees and so on.

Whether or not drying actually approaches in efficiency these theoretical figures depends largely on the humidity of the air. Air near its saturation point gives up its heat much less readily and will consequently take up water more slowly than comparatively dry air. Rapidity of movement of the currents of air also influences their drying capacity. As a general thing, very little change of temperature is ever actually noticed in outside drying but the drying depends largely on the air circulation. The more rapidly this takes place, the more air is brought in contact with the clay and consequently drying progresses more speedily.

In closed chamber dryers the conditions are different from those discussed in several particulars. The air no longer cir-

culates of itself but a draft must be produced to move it. The heat for drying is not contained in the air as it enters from the outside, but must be supplied to it artificially. Both movement of the air and heating it requires the expenditure of energy which is not necessary in out of door drying. Of the heat supplied to the air, it is clear that not all is utilized in the evaporation of water; for this air leaves the dryer at a higher temperature than it enters, thus carrying out considerable quantities of sensible heat. Likewise, the brick enter the dryer at atmospheric temperatures and leave it at much higher temperatures. These two are the chief sources of waste of heat in the dryer and are in turn briefly treated.

On leaving a drying chamber, one cubic meter of vapor saturated air at 30° C. consists of .958 cubic meter of dry air and .042 of water vapor, ($\frac{760 - 31.6}{760}$) where 31.6 is the tension of aqueous vapor.

The .958 cubic meter of dry air can hold the following heat units:

$$\frac{1.293 \times .958 \times .237 \times 30}{1 + .00367 \times 30} = 7.935 \text{ heat units.}$$

When this same dry air entered the dryer at, say, 10° C., it had a volume of,

$$\frac{958}{1 + .00367(30 - 10)} = .893 \text{ cubic meters.}$$

This volume of air could carry as it came into the dryer,

$$\frac{1.293 \times .893 \times .237 \times 10}{1 + .00367 \times 10} = 2.639 \text{ heat units.}$$

The amount of heat taken out of the dryer, therefore, in each cubic meter of air under the assumed conditions is, 7.935 — 2.639 = 5.296 heat units.

The above result is obtained on the assumption that the air on issuing from the dryer is completely saturated. This is seldom if ever true. Its degree of saturation or, relative humidity, may be ascertained in any instance and the value used in the

formula. Assuming for example, that the outgoing air is but half saturated, which is ordinarily more nearly the case, similar calculations to the above will show that at 30° C. 8,108 heat units will be carried out per cubic meter of saturated air. At 10° the same air carries in 2.696, making a loss in this case of 5.412 heat units. If each cubic meter passing through the dryer causes a loss of 5.412 units of heat, the total loss per each thousand brick is 56,610 heat units.

In the same manner may be calculated the loss of heat incurred by bringing the air into, and removing it from, the dryer at any observed temperatures.

We have seen that at these low temperatures 611 heat units are required for the evaporation of each kilogram of water. As has been shown, to remove the water from 1,000 brick (772 kgms.) requires 471,692 heat units. And since each cubic meter of air at the highest temperature, 30° C., can evaporate 13.55 grams of water, to dry 1,000 brick takes 772×13.55 or 10,460 + cubic meters of air.

Seger gives the following formulæ for the calculation of the capacity of chimneys.* In their practical application these expressions may be used for determining the dimensions of a stack for circulating an amount of air, at the temperatures of operation, which is found necessary to remove the water from a given amount of clay in the time required to dry it.

$$v = 628 \sqrt{\frac{(t - t')dh}{4.08 + .016h}} = \text{velocity of air in meters per minute and,}$$

$$V = \frac{3.1416d^2v}{4} = \text{volume of air in cubic meters per minute.}$$

In these formulæ:

$t - t'$ = the temperature difference between the shaft of the chimney and the outside air,

d = the diameter of the chimney at its mouth,

h = the height.

* Collected Writings of Hermann A. Seger, p. 268.

The clay as it enters the drying chamber has the temperature of the atmosphere and as it leaves carries out considerable quantities of sensible heat. The specific heat of clay is about .2. The heat carried out is calculated by the weight of the ware, or, M , multiplied by .2 ($t - t'$) where $t - t'$ = difference in temperature of the brick at entrance and exit. One thousand brick contain on an average 7,700 pounds, 3,500 kilograms, of dry clay. Under the conditions assumed above, $3,500 \times .2 (30 - 10) = 14,000$ heat units per thousand brick.

We have now obtained the amount of heat used in the evaporation of the water from 1,000 brick, 471,692 heat units; that taken out as sensible heat in the escaping half-saturated air, 56,110, and the heat dissipated by the clay itself, 14,000 heat units. Total energy necessary to dry 1,000 brick, neglecting radiation, is, therefore, 542,302 units of heat.

This energy is supplied in artificial dryers by the combustion of fuel. The average Iowa coal furnishes 6,700 heat units per kilogram. To dry a thousand brick, requires the consumption, therefore, of, in round numbers, 81 kilograms, or 178 pounds of coal.

By carrying out similar calculations to the above for a range of temperatures and different degrees of humidity, it may be shown that (1) economy can never be obtained unless the air is removed very nearly saturated. The rule in this regard is, therefore, to remove the air only after it has taken up practically all the water vapor it can hold, and before dew is deposited. (2) Economical drying in closed compartments can be had only at temperatures above 50° C. (122° F.), and below 100° C., when the air is removed as nearly saturated as possible. The amount of heat carried out by the air rises rapidly as the humidity decreases; and as the temperature of drying is lowered the ratio of heat loss to that actually used in the evaporation of water increases very rapidly.

By the application of the physical principles here given, it is believed that much information can be gained regarding the efficiency of drying systems. Observations on the temperature and the humidity of the in and out-going air, the amount of water in the ware to be dried and the fuel consumed will furnish ample data for computing the working efficiency of the dryer.

PRACTICAL CONSIDERATIONS IN DRYING CLAYS.

Although the preceding discussion of physical principles shows just what economy can be attained in drying under ideal or assumed conditions, and at the same time furnishes a means of gaining information regarding the efficiency of any drying system under practical working conditions, it is scarcely if ever possible to plan the operation of a dryer alone on these principles. If the drying of clays were alone a matter of water evaporation, heat and air supply could be so proportioned as to accomplish this with the smallest possible waste. Since, however, the preservation of the form and strength of the ware itself is the primary consideration, drying must be so conducted as to most economically remove the water while retaining these necessary characteristics of the ware dried. That is, instead of constructing and operating a dryer after the theoretical principles on which the evaporation is based, the problem must be approached from the standpoint of the character of the clay to be dried. It is evident, therefore, that in order to dry a given clay safely it may be necessary to use several times the heat and volume of air physically required to evaporate the water. Heat and fuel consumption, therefore, become secondary in importance, and economy in this respect must very often be almost entirely disregarded. In many instances it is possible, however, to greatly curtail the expense of drying by applying a knowledge of the physical side of the process, and still preserve the best quality of the ware. The readiness with which clays dry depends chiefly on

the relative proportions of clay substance and non-plastic matter that they contain; and on the shape and size of the particles of the non-plastic material. In other words, the structure of the clay is all important. Clay substance as it occurs in ordinary clays possesses the finest grain of any of the constituents and because of its cleavage structure takes up and holds water with tenacity. If the flakes of clay substance are coarse as in some residuary kaolins, it imbibes little more water than would be taken by so much sand. In some secondary clays it has been found that the sand grains present are as fine or finer than the particles of kaolinite. In such instances, they increase the difficulty of drying because the fine grains of sand tend to hold water by capillarity, as does clay substance, the more water is so held the smaller the grain.

The two factors mentioned control the ease with which water reaches the surface of a mass of drying clay when it is bathed in drying currents of air. In general, the higher the proportion of non-plastic material the more rapidly the clay will dry safely but the less will be its strength. Of course the limit to the amount of non-plastic matter it is possible to use is largely determined by the allowable extent to which cohesive strength can be sacrificed in the dry ware. The finer the grain of the inert matter the less will it influence plasticity and shrinkage. A medium fineness reduces shrinkage most with the least impairment of strength. The influence of non-plastic substances on clays has been more fully treated in the chapter on Physical Properties of Clays.

The operation of removing water from clay ware, commonly regarded as a continuous process, may fairly be divided into three more or less well defined stages. These are: (1) heating, up stage, (2) period of shrinking, (3) stage of evaporation or completion of the drying proper.

Under ordinary circumstances, clay wares come from the molding machinery at the temperature of the atmosphere. The pieces of ware are to be placed in the dryer which has a much higher temperature. If the humidity of the dryer atmosphere be low, this sudden change causes the clay to at once begin to dry very rapidly on the outside before the interior portions have passed beyond atmospheric temperature. Under these conditions, the outward flow of moisture is more sluggish than if all portions are equally heated before drying is allowed to begin. Shrinkage strains are thus set up which often result in cracked ware. In order to obviate this difficulty, the ware must either be heated very gradually, or be introduced into a dryer atmosphere which is already nearly saturated. The latter method is usually more expediently employed.

In the continuous dryer, which is most used at the present time, it has been found most practical as well as economical, to allow the ware to stand in a steamy atmosphere until thoroughly heated through before drying is permitted to begin. This precaution is especially important if the clay is a tender one. After the clay has reached the temperature of the entrance end of the dryer, it is ready for movement into less humid air where the second, or shrinkage stage, begins.

As soon as shrinkage begins, the process is carried forward as rapidly as the clay will stand. Damage most often results in this stage even if the first has been safely passed. Greater care and longer time are required in this period for tender clays than for strong ones. The humidity of the air is decreased and the temperature raised as the clay shrinks less and less.

At the close of this period the water which the clay still contains is held in the pores of the clay and is known as pore water. The small clay particles because of the removal of the water from between them have settled together until they touch each other at all possible points. We do not conceive their size to be

constant nor their shape rectangular, so there still exists between them innumerable small cavities which, after shrinkage has progressed as far as it will, are still filled with water. The amount of water thus held, which must be driven out in the final stage, ranges from 4 to 15 per cent.

The removal of this remaining moisture becomes essentially a problem of evaporation. When shrinkage ceases there is no longer any danger of damage to the ware unless the temperature is elevated to 212° F., or boiling. Steam is formed in the pores of the clay at this temperature and popping or "blowing" is apt to result.

At the completion of this final stage of drying the clay is said to be "bone" or "white" dry and is ready for the kiln although it still contains sometimes as high as 3 per cent of water. The moisture which the clay still holds is hygroscopic and can be removed only at boiling temperatures. It is of little use to remove this in the dryer as it is again absorbed when the ware is brought in contact with the atmosphere.

There are five typical methods of accomplishing the drying of clays: (1) Outside air drying; (2) the hot floor; (3) sewer pipe or slatted floor; (4) periodic or chamber dryer; (5) the continuous tunnel dryer.

OPEN AIR DRYING.

Open air drying is carried on in two ways, viz., by standing the brick edgewise on a level area of ground with no cover whatever, and, by the rack and pallet system, the racks usually being provided with some form of roof protection. In the former case, the ware is dried by the circulation of air over the upturned surfaces, while in the latter a better circulation around and between the separate brick is possible. While by this method of drying there is little expense involved in equipment and none whatever in the production of the necessary heat, there are still

a few valid drawbacks which render it generally uneconomical. These objections may be summed up in the fact that, the drying depends upon the weather, in other words, it is a fair weather method. No two days furnish exactly the same atmospheric conditions with reference to temperature, humidity and circulation of the air. The atmosphere one day may be windy, dry and

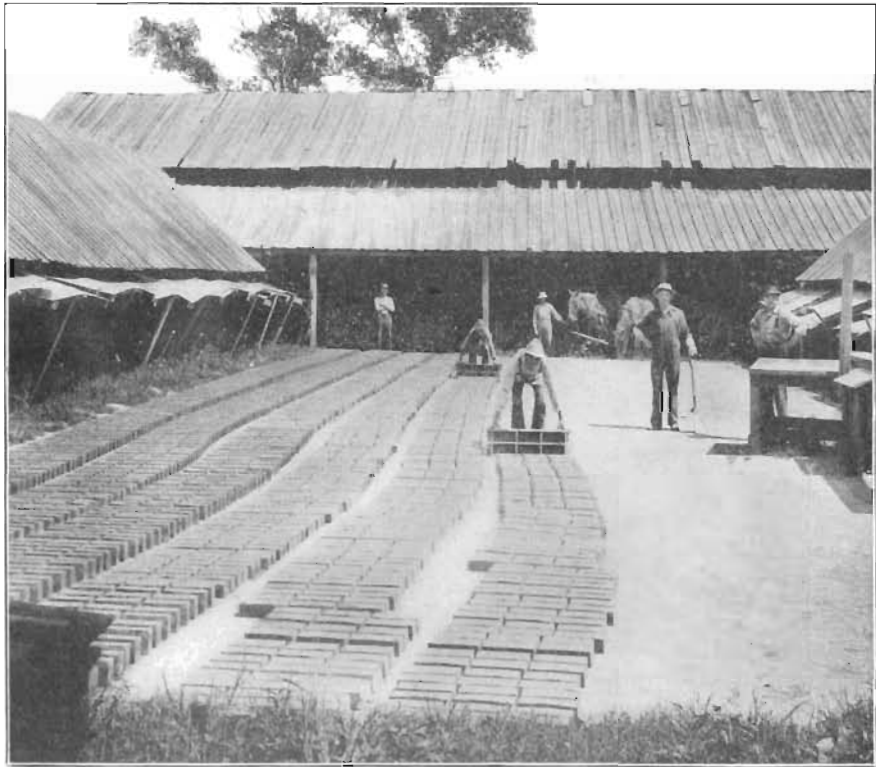

FIG. 23. Open air drying, Samuel's Brickyard, Muscatine, Iowa.

warm, and on the next, quiet, humid and relatively cooler. It is true that unless the clay be an exceptional one, it will not endure such treatment without suffering injurious results. This means of drying is uncertain since the drying conditions are entirely beyond the control of the brickmaker. It is much less used now than formerly.

THE HOT FLOOR DRYER.

The hot floor is still used in some sections of the country. It was first devised for drying fire brick and later employed in the paving and common brick industries. The hot floor consists of a solid floor of brick, cement or iron on which the brick are placed on edge or on end, as in outdoor drying. The floor is heated from beneath usually by fuel burned for the purpose. The pieces of ware, as they are commonly placed quite close together, are bathed on the upper surface by cool currents of air sweeping over them. Their under surfaces are raised to a temperature near boiling by contact with the heated floor. As the brick are usually set, there is little circulation of air between them so that the water leaves the clay by being forced from the bottom towards the upper surface. The air is somewhat heated by radiation from the floor but escapes before it has taken up nearly all the water it is capable of holding. A great deal of heat is in this way wasted. The method is thus lacking in economy from the standpoint of fuel consumed; and also from the fact that few clays will stand this sort of treatment without the loss of a considerable percentage of the ware.

SEWER PIPE OR SLATTED FLOOR DRYER.

The sewer pipe or slatted floor, as the name would indicate, is used principally in the sewer pipe and other hollow ware industries. The construction of such a drying plant is perhaps more expensive than any other type. It usually constitutes the working floors of the factory building, never less than three stories, and often more, in height. The floors are made of narrow lumber with small spaces, commonly one inch, between them. The building and floors must of necessity be very strongly constructed because of the enormous weight they must bear when loaded with ware. The method of heating is almost universally a system of steam pipes hung twelve to fifteen inches beneath each

floor. During running hours, exhaust steam from the engines is supplied to these pipes and for the rest of the time live steam is used. No means of ventilation are ordinarily provided other than doors and windows. There are no well defined currents in any direction. The warmer, drier air naturally rises and the strongest drying conditions are found on the upper floors. The moist and cool air settles to the lower floors. This fact is taken advantage of by the manufacturer and the most tender clays and the most difficult pieces of ware to dry are set on the lower floors where they may dry gradually.

The shape of the individual pieces of ware of sewer pipe, terra cotta, fire proofing, hollow block, etc., is such that they are the most difficult of all clay wares to dry without cracking. It is therefore necessary because of the character of the ware that a system of drying be used which is very wasteful of heat. The same clay made into brick and placed in a tunnel dryer would dry with half the heat and in a small fraction of the time. On the sewer pipe floor the wares are surrounded by an atmosphere of equable temperature and while there is gradually an interchange of air from one part of the building to another, in no place is the draft sufficient to bring about any sudden change in the temperature or humidity of the air surrounding the ware.

It will be noticed that in the three methods of drying so far considered, the three stages of the drying process, viz., heating, shrinking and evaporation, are not separable. They are all merged into one continuous action practically eliminating the first stage. In the two following types of dryers these stages are quite distinct and in this lies the economy and success of the tunnel dryer over the open air and hot floor systems.

PERIODIC OR CHAMBER DRYER.

The chamber or periodic dryer is usually built on the tunnel plan, the details of construction only differing materially from

the continuous system. It consists of one or more compartments or units provided with means of inlet and outlet for the drying air, both being under complete control. In this dryer the ware is subjected to a series of conditions, representing successively the three typical stages in the drying process. The whole compartment is operated as a unit through the different stages until a charge of ware is completely dried, then it is removed and the entire operation is repeated with the next charge.

The air inlet is a series of small openings from a large sewer running the whole length of the chamber. These openings are controlled by dampers and are so proportioned that their total area will not exceed 50 per cent of the cross section of the main air duct. This provides for sufficient and equal pressure of air through each. The air is heated either before or after entering the compartment, preferably by steam coils placed beneath the track and just above the roof of the air flue. Any method of heating which can be worked in the continuous dryer is equally applicable here. Side coils in the tunnel are of little value as the air that is heated by them does little drying and they often crack the ware close to them. It has proven most successful to use a three part steam coil, all parts being below the track. One of these is turned on at the beginning, a second when shrinkage begins and the full heat of all three in the finishing stages. The air, admitted beneath these coils, passes up through them and reaches the ware uniformly heated through the length of the dryer.

The outlet system is most frequently a number of wooden chimneys opening directly to the exterior. The same end may be accomplished by one large central chimney providing a collecting flue and is constructed corresponding to the main air duct of the inlet system. For the same reason that it is advantageous to admit the air through a series of small openings, is the operation best carried on by removing the air through small apertures into

this collecting flue, the aggregate area of which is less than the cross section of the stack. The entire outflow of air may then be controlled by a damper in the stack.

The chamber dryer is adapted to the handling of a greater range of clays than any other device because of the complete control which may be exercised over the drying conditions. It is, however, low in economy when compared with the continuous dryer. The temperature of the chamber must be lowered nearly to that of the atmosphere after the removal of a charge of brick, before it is safe to put in fresh wet brick. Much of the dryer atmosphere is discharged into the outer air far below saturation, thus involving the waste of large quantities of heat. Being operated intermittently, the capacity of the chamber dryer is necessarily limited. Its wastefulness of heat and its limited capacity render it less efficient than the continuous dryer.

CONTINUOUS TUNNEL DRYER.

Much the larger number of drying plants installed in late years are of the continuous type. It is becoming more and more necessary for clay workers to employ the most economical means and equipment by which the raw clay can be most speedily turned into the best ware, in order to meet competition and to conduct their business on a paying basis. The time has passed when the saving of fuel is a secondary consideration. Around our best clay plants at present, measures are taken to utilize every possible heat unit. The continuous dryer is the result of the efforts of clay workers to get the largest amount of heat out of every pound of coal that is burned. In the accomplishment of this purpose, it has proved the most economical and efficient method yet devised. The dryer house is similar in construction to the chamber-dryer already considered. The mode of operation necessitates changes in the arrangement of stacks and heating apparatus. Its operation consists in admitting the supply of heated air at

one end of the tunnel and discharging it through a stack at the other. As the air progresses towards the exit, it becomes gradually more and more humid by contact with the wet ware, so that when it reaches the chimney it should be nearly saturated. The ware is admitted at the stack end of the dryer, where it meets a current of very moist air; and progresses towards the hot end, gradually moving into a less humid atmosphere as new ware forces it ahead. The three stages of drying are, in this class of dryer, not distinct, but overlap each other more or less, all of them going on at once in the same compartment.

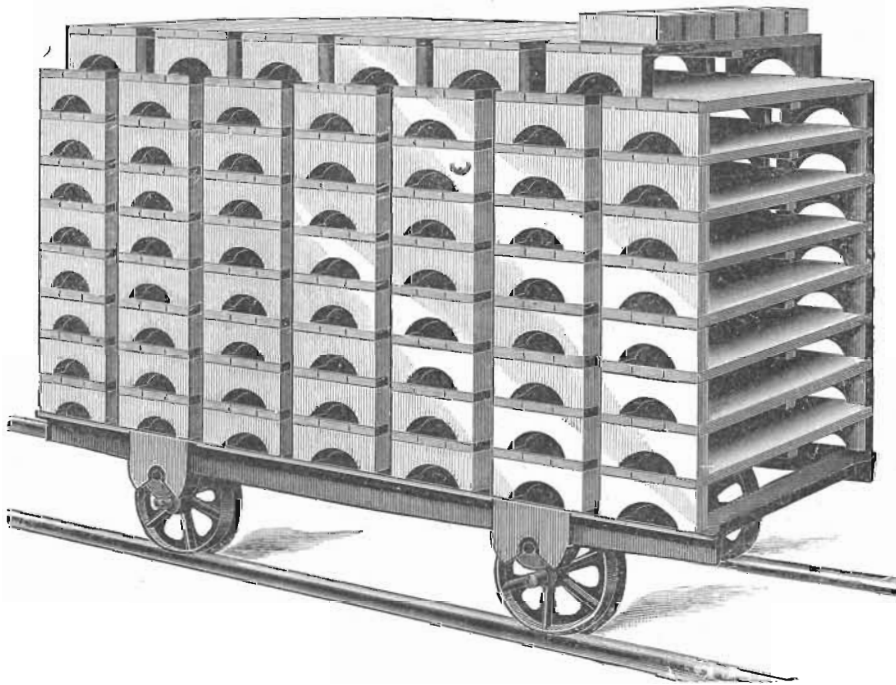

FIG. 24. Cast iron flat car with pallets.

It has been found necessary to adopt certain modifications in the construction of the tunnel as it was first built, in order to adapt it for drying the more tender clays. These modifications have all been such as to differentiate more sharply between the typical stages of the drying process. In order to direct the

movement of the air near the entrance through the clay, a valve or vertical sliding door between the dryer and the stack is used. By this expedient, the air must settle to gain exit to the stack beneath the valve. This arrangement produces a zone of extreme humidity three or four cars long in which the ware becomes thoroughly heated but dries scarcely any. The cars meet less saturated air as they are moved along and enter the second zone, which corresponds to the second theoretical stage of drying, viz., shrinking. They do not reach this zone until they are well heated and ready to give up their water, and are moved into the third zone as soon as shrinkage ceases, where they meet hot, dry air right from the coils. Experience with a given clay soon teaches the operator how rapidly the cars may be pushed forward.

In the case of some very tender clays it has been found advantageous to modify the construction by extending the dryer in length and placing the stack at the end of zone No. 1. The usual heating arrangements are employed at the hot end and also a small auxiliary apparatus under the entrance end. When the brick first enter the tunnel they stand in a currentless atmosphere until thoroughly heated before being advanced to zone 2. The position of the stack is not fixed at any definite point but is located to fit the behavior of any given clay.

The principal variations among dryers of this type are found in the methods of heating the air which does the drying. In general, these may be classified under two heads, direct and indirect. In direct heating the heat units generated by the combustion of the fuel are conveyed directly to the ware to be dried by moving currents of air. The transfer of heat by moving currents is termed convection. The air is heated indirectly by radiation. The heat units from the burning coal are first absorbed by some other medium, then given off to the air which enters the dryer. The two general classes may be subdivided as follows:

- Direct { By fuel burned for the purpose.
 { By waste gases from other processes.
- Indirect { Radiation from heated brick work.
 { Radiation from steam heated surfaces.

There are several well known examples of the type which conducts the combustion gases into the drying chamber. The parts to such a dryer may be designated as follows: Furnace, combustion chamber, fan, cold air inlet, commingling chamber, hot air flue, dryer.



FIG. 25. Double deck steel car.

From the furnace the gases pass through a chamber of highly heated brick work from which they issue practically free from smoke or soot to the fan. Cold air is also admitted to the fan, both warm and cold being forced into the mixing chamber from which it is distributed to the dryer. In some instances a mechanical stoker is employed by means of which the fuel is evenly

fed to the fire and perfect combustion maintained as nearly as possible. The inflow of cold air is under control and is regulated by using a thermometer in the commingling chamber.

Drying by Fuel Burned for the Purpose: The plan of drying clay ware by burning fuel for this purpose alone is believed to be wrong in principle from the fact that much more heat is wasted daily around the ordinary plant than would be needed to dry the output, and much of which might be reclaimed for this purpose. This system is bad from the standpoint of fuel economy. Two other principal objections have been found to this method, viz., sooting, and the deposition of an acid dew causing scumming of the ware. The former has been practically overcome in the successful dryers of this type by the perfect combustion rendered possible in the use of the mechanical stoker. Perfect combustion, however, means thorough oxidation of all fuel ingredients. Some of the sulfur in the coal is thus oxidized to sulfurous acid which forms sulfuric acid by combining with the water vapor of the combustion gases. It is always economical, of course, to maintain the atmosphere near the entrance end of the dryer as nearly saturated as possible, and in the case of very tender clays it is even necessary to allow it to deposit slightly. The deposition of a dew containing sulfuric acid will, therefore, if not intentionally, sometimes accidentally, happen. Any ingredient in the clay subject to the attack of this acid will at once combine, and whitewashed ware will often result from this cause where it would never be produced under other conditions.

The use of a fan for controlling the draft has the advantage over natural draft in that it is a positive force, moving exactly equal volumes of air during similar periods of time, and while the temperature and humidity may vary from day to day the speed of the fan may be adjusted so as to pass the requisite amount of air under different conditions. This is not possible with natural draft where the intensity depends upon the weather conditions.

The first cost of the plant, equipped with mechanical stoker and fan, would not differ from that of the average dryer similarly equipped. Rather more brick work is required in its construction than in other dryers but this extra brick work would hardly offset the piping in the steam dryer.

Drying by Waste Gases from Other Processes: This method has not yet come into extensive practice. Cases are known, however, where the smoke and fuel gases are drawn by a fan directly into the dryer. One instance is recalled where the brick came out covered with soot from a dryer temperature of over 260° F. Even the wood on the cars was charred and a good share of the brick was cracked and checked from the excessive temperature. This was a case of extreme lack of control, but it is never safe to turn the combustion gases themselves directly into the ware. Scumming will very frequently result; if not, a most lavish waste of heat. The gases from a kiln are not uniform in character, sometimes oxidizing, sometimes reducing, sometimes containing a large excess of air and sometimes very small. Drying by this means is accomplished in the continuous kiln, and here with the greatest possible heat economy. Great care is taken, however, to turn the gases into the stack before they have cooled down to their dew point. Sooting is not objectionable in the kiln, as the ware is not handled until after it is burned and the drying merges directly into the beginning stages of burning. It is sometimes advantageous to draw the atmosphere from a cooling kiln into the dryer. In fact, in some up to date plants this method is exclusively used. The obstacle to its more extended application for drying appears to be the large amount of tunneling or piping required and the difficulty of regulation so that a constant supply of the proper temperature can be obtained. Further, few plants are operated on such a scale that the drying could be done by this means alone. It is believed, however, that the utilization of the waste heat from cooling kilns

in this way is a big stride ahead in the economy of clay working.

Drying by Radiation from Heated Brick Work: The Sharer dryer is a type of the indirect in which heat is supplied by radiation from brick work. It is provided with furnaces under the discharge end. The gases pass through flues beneath the floor of the dryer tunnels and out through the stack at the entrance end. The air is admitted through openings on each side of the fire boxes which lead directly into the dryer chambers. The moist air from the tunnels and the products of combustion gain exit through the same stack. The hot fuel gases in this way constantly stimulate the draft of the dryer, making it depend less on the condition of the outside atmosphere than in most other natural draft dryers.

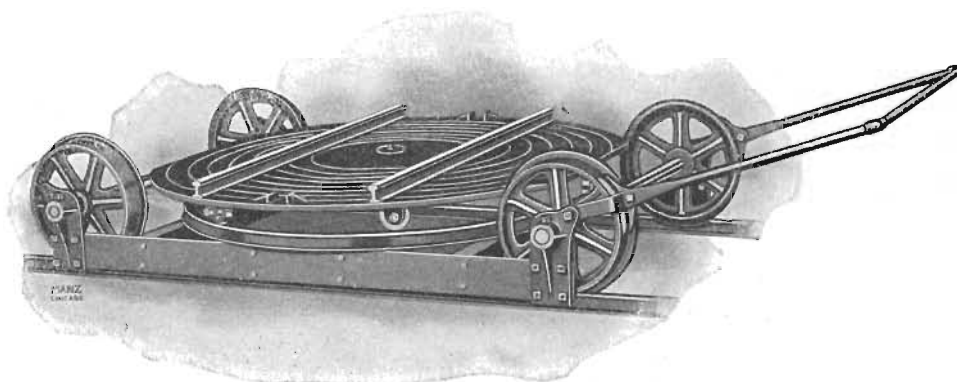

FIG. 26. Combination transfer car and turntable.

This system is the hot floor in principle, but the heat is made to accomplish much more work than on the hot floor because confined to a smaller area. Here also the ware is not in contact with the hot brick work but is bathed alike on all sides by warm currents of air. The cost of construction and maintenance is comparatively low. It is possible to make this class of dryer do excellent work on the stronger clays but it is impossible to attain the fine degree of regulation of the heat essential to drying

tender clays. Viewed from the point of fuel economy, the system is wasteful. Enormous amounts of heat are going to waste in exhaust steam and from cooling kilns which might be controlled and utilized for drying purposes. It seems scarcely advisable to erect a dryer which in itself adds to this total waste instead of saving from the other processes.

Drying by Radiation from Steam Heated Surfaces: The second subdivision under indirect heating is by radiation from steam heated surfaces and is exemplified in the use of steam piping. The piping is sometimes extended as in the sewer pipe floor, but in the continuous dryer is usually a medium or very compact coil or radiator. In some cases, live high pressure steam is used; in some exhaust steam; while in the large number of steam tunnel dryers the necessary arrangements are provided for using exhaust steam during running hours and live steam for the remainder of the 24 hours. This has proven quite satisfactory and utilizes much heat that would otherwise be lost.

The question of the relative efficiency of live and exhaust steam for drying purposes has often been raised. Examined from all points of economy, it is believed that the exhaust steam has points in its favor. When not so used, exhaust steam is a waste product which carries out a large number of heat units. Exhaust steam forced into a dryer scarcely ever has a temperature higher than 214° or 215° F. This steam condensing to water liberates 537 heat units for every gram of water. Steam under a pressure of 150 pounds will have a temperature of about 300° F. The actual difference in heating power lies in the amount of heat held by the steam between 212° F. and 300° at 150 pounds pressure which, compared with the 537 heat units set free by condensation, is insignificant. Live steam is more satisfactory where it is necessary to attain high temperatures, but in the long run the extra fuel consumed will far outweigh the advantages of the live steam.

There are several advantages which may be claimed for the use of steam over other methods of drying. First, the ease with which it may be conveyed and held in control in inaccessible positions. Second, immunity from fire. Third, the ease of distribution from a central plant. Fourth, and the most important reason why it should be used, it is utilizing the waste heat from other processes.

SUMMARY.

The drying plants found among the clay working establishments of the state may be classified under the preceding types. The use of the open air method is limited practically to the drying of soft mud, sand mold brick. The rack and pallet system is used for drying both soft and stiff mud brick. A modification of the rack system is employed in places. The racks are protected by a permanent roof and side walls which can be opened and closed at will, and by means of which the circulation of the air through the brick is regulated. To provide for weather when outside air can not be used, such dryers are often supplied with steam piping into which exhaust or live steam may be turned.

Drain tile and hollow block are dried in rack dryers and in the various styles of continuous steam dryers. They are usually made in connection with the manufacture of brick and receive similar treatment in drying. The enclosed rack dryers are frequently built with a floor above the racks on which tile and hollow blocks are dried by setting on end. Sewer pipe are dried on the sewer pipe floor and in some places in the tunnel dryers, although the latter is rather dangerous unless the clay is exceptionally strong.

Stone and earthenware pottery are dried in racks especially designed to accommodate the molds in which the pieces are made or to fit the pieces of ware if they are hand turned. The dryer is a portion of the factory building and is commonly heated by

steam piping or stoves. It is seldom that any provision for ventilation is made aside from doors and windows. Dry press brick contain but little water and do not shrink, so are seldom put into a dryer. The necessary drying is accomplished in the kiln during the early stages of burning.

Burning of Clay Wares.

COMBUSTION OF FUEL.

The burning of clays is accomplished by the consumption of fuel. Strictly speaking, the effect of heat on a clay is not to any extent one of burning, which implies combustion or oxidation. The changes that are brought about are prevaillingly chemical reactions in which compounds are broken up or new combinations formed between the constituents of the clay. Certain reactions occur at certain temperatures and are completed within narrow limits. It is fundamentally the application of the heat derived from the combustion of fuel which brings about these changes.

The amount of heat generated by fuels may be determined in two ways, by calculating from the chemical composition and by actual measurement of the heat evolved in the combustion of a known quantity. An instrument known as the calorimeter is employed in the latter determination. By means of this apparatus, the heat of combustion is measured by observing the rise in temperature of a definite volume of water which surrounds a small chamber in which the fuel is burned.

The heat of combustion is spoken of as the calorific power of a fuel and is expressed in terms of assumed heat units. These units may be of any size, as has been shown under Drying. It is necessary to know the elementary analysis of a fuel in order to calculate its calorific power. The results obtained by calculation are not as accurate as can be secured in the calorimeter

but careful check determinations, both by analysis and calorimetrically, can be made to give fairly concordant results in the majority of cases.

The calorific power of a fuel is calculated by the following expression:

$$C. P. = 8080 C + 34462(H - \frac{O}{8}) + 2250 S \text{ in which:}$$

C = percentage of carbon. H = percentage of hydrogen. O = percentage of oxygen. S = percentage of sulfur. 8080 = heat of combustion of carbon. 34462 = heat of combustion of hydrogen. 2250 = heat of combustion of sulfur in kilogram calories.

The common fuels are compounds of carbon, hydrogen and oxygen. The most common of fuels, coal, universally contains sulfur. All of these elements except oxygen are combustible and give off heat in burning. The oxygen is conceived to be in combination with hydrogen as water, hence the deduction $(H - \frac{O}{8})$ in the formula. In soft coals the percentage of oxygen is higher than in anthracite and lower than in wood. Wood and peat contain higher proportions of oxygen still and for this reason are lower in fuel value than coal.

The above formula takes into account these variations and expresses the heat of combustion in kilogram calories. A common method of expressing quantity of heat is by British Thermal Units (B. T. U.). The formula corresponding to the above is:

$$C. P. = 14500 C + 62032(H - \frac{O}{8}) + 4050 S.$$

To transfer from one unit to the other, it is necessary to employ the factor 1.8, the ratio between the Centigrade and Fahrenheit thermometric scales.

Professor G. W. Bissell has found from a study of Iowa coals that the actual heating values may be determined approximately from proximate chemical analyses by the following formula:

$$B. T. U. = 14,500 C + 12,100 V. + 4,000 S$$

in which B. T. U. = the number of lbs. of water which can be raised 1° F. by the combustion of 1 lb. of dry coal; C = Fixed carbon; V = Volatile hydrocarbons and S = Sulfur.

The following table includes representative analyses from all of the leading coal producing counties in Iowa. But little calorimetric work has been done on Iowa fuels. The results at hand are included in the table.

| COUNTY. | Moisture. | Volatile hydro-carbons. | Fixed carbons. | Ash. | Sulfur. | Calorimetry B. T. U. |
|----------------------------------|-----------|-------------------------|----------------|-------|---------|-------------------------|
| Adams— | | | | | | |
| Average 6..... | 8.76 | 34.22 | 45.12 | 11.89 | 3.60 | |
| Appanoose— | | | | | | |
| Average 12..... | 7.26 | 35.87 | 47.67 | 9.20 | 3.75 | |
| Centerville..... | 11.49 | 33.47 | 48.56 | 6.52 | 2.92 | 12681 |
| Mystic..... | 16.21 | 32.74 | 46.00 | 5.05 | 2.64 | 12780 |
| Boone— | | | | | | |
| Average 6..... | 6.82 | 40.99 | 44.45 | 7.74 | 4.01 | |
| Crowe Coal Co..... | 4.03 | 39.79 | 48.30 | 7.88 | 3.99 | 12729 |
| *Street Railway Power Plant..... | 11.49 | 26.33 | 37.83 | 24.36 | 9.53 | |
| Dallas— | | | | | | |
| Average 8..... | 8.25 | 35.11 | 42.17 | 14.47 | 4.24 | |
| Davis— | | | | | | |
| Average 5..... | 2.95 | 41.82 | 44.47 | 10.66 | 6.07 | |
| Bloomfield..... | 5.24 | 37.00 | 50.66 | 7.10 | 2.25 | 13204 |
| Greene— | | | | | | |
| Average 4..... | 9.01 | 42.11 | 42.03 | 6.86 | 3.37 | |
| Guthrie— | | | | | | |
| Average 7..... | 7.41 | 35.82 | 42.18 | 14.59 | 6.08 | |
| Jasper— | | | | | | |
| Average 4..... | 7.40 | 37.64 | 43.17 | 11.08 | 3.46 | |
| Colfax..... | 5.45 | 40.49 | 46.97 | 7.09 | 2.91 | 12134 |
| Keokuk— | | | | | | |
| Average 6..... | 6.11 | 39.43 | 44.39 | 10.07 | 6.36 | |
| Lucas— | | | | | | |
| Average 5..... | 9.40 | 37.65 | 44.08 | 8.87 | 3.34 | |
| Mahaska— | | | | | | |
| Average 7..... | 4.29 | 43.04 | 44.56 | 8.11 | 4.38 | |
| Marion— | | | | | | |
| Average 4..... | 6.17 | 37.79 | 49.27 | 6.78 | | |

* Steam coal.

| COUNTY. | Moisture. | Volatile hydro-carbons. | Fixed carbon. | Ash. | Sulfur. | Calorimetry B. T. U. |
|---------------------------|-----------|-------------------------|---------------|-------|---------|-------------------------|
| Monroe— | | | | | | |
| Average 8..... | 5.55 | 40.38 | 44.42 | 9.65 | 5.21 | |
| Hocking (Mine No. 3)..... | 6.63 | 38.37 | 40.88 | 14.12 | 6.92 | |
| Hocking (Mine No. 2)..... | 5.80 | 42.56 | 42.71 | 9.03 | 3.75 | 12560 |
| Hilton..... | 6.51 | 37.97 | 45.07 | 10.45 | 3.02 | 12396 |
| Buxton No. 10..... | 9.48 | 35.58 | 46.07 | 10.87 | 2.06 | 12030 |
| Buxton No. 9..... | 6.19 | 43.60 | 42.30 | 5.91 | 3.45 | |
| Polk— | | | | | | |
| Average 5..... | 6.43 | 38.84 | 44.77 | 11.96 | 4.87 | |
| Marquisville..... | 5.09 | 43.30 | 47.73 | 3.88 | 2.60 | 10574 |
| Scott— | | | | | | |
| Average 6..... | 3.61 | 39.95 | 47.13 | 9.29 | 4.71 | |
| Taylor— | | | | | | |
| Average 5..... | 5.93 | 36.17 | 44.54 | 11.34 | 4.85 | |
| Van Buren— | | | | | | |
| Average 3..... | 8.10 | 40.01 | 47.43 | 4.45 | | |
| Wapello— | | | | | | |
| Average 11..... | 5.42 | 38.73 | 45.25 | 10.60 | 5.58 | |
| Pekay..... | 9.98 | 41.46 | 42.21 | 6.35 | 2.53 | 13050 |
| Laddsdale..... | 4.23 | 40.92 | 45.76 | 9.09 | 4.75 | 13141 |
| Willard..... | 10.94 | 32.90 | 48.27 | 7.89 | 2.55 | 12245 |
| Warren— | | | | | | |
| Average 4..... | 10.60 | 38.26 | 43.75 | 7.36 | 4.44 | |
| Wayne— | | | | | | |
| Average 4..... | 9.01 | 34.48 | 43.43 | 13.07 | 3.84 | |
| Webster— | | | | | | |
| Average 10..... | 7.83 | 37.23 | 43.42 | 11.52 | 5.08 | |
| Lehigh..... | 17.47 | 31.35 | 39.59 | 11.59 | 4.87 | 12431 |

Either calculation or direct determination by the calorimeter gives the total number of heat units evolved by the oxidation of the fuel elements. They do not give the heating value of the fuel, however. The new compounds formed in burning use up a greater or less amount of heat depending on their nature, as both latent heat of vaporization and sensible heat of the waste gases. The energy from a fuel, therefore, that remains to produce changes in a clay or to evaporate water in a boiler is always less than the

determined calorific power. Another cause of divergence from the theoretical heating power is that of incomplete combustion. Complete oxidation is necessary to attain the highest heat evolution. Practically, this is seldom accomplished. Further, the supply of oxygen coming into a furnace is never minutely proportioned to the exact amount required for complete oxidation. There is sometimes an excess, sometimes a deficiency. The former is much more common. Since the oxygen of combustion is supplied from the air, there comes into the kiln, nitrogen, in the proportion to oxygen in which the two elements exist in the atmosphere. The excess of oxygen and the inert nitrogen must both be heated to the temperature of the furnace and thus carry out large quantities of heat. The available heating power of a fuel, therefore, is the excess of the total heat evolved over that used up in the ways indicated.

The following example will illustrate the method of calculating, (1), the losses from the above causes, (2), knowing these losses, the available heat from the combustion of the fuel.

A coal of the following analysis,

Carbon = 80 per cent
 Hydrogen = 5 per cent
 Oxygen = 7 per cent
 Sulfur = 2 per cent
 Ash = 6 per cent

has a calorific power of 7930.55 heat units by the formula given on a preceding page.

To find the weights of the various gases resulting from the complete combustion of the above coal:

Carbon: $C + 2O = CO_2$, i. e., 12 (atomic weight of carbon)
 $12 + 32 = 44$

parts carbon give 44 parts (1:3.66) carbonic acid gas on combustion. Burning 80 parts of carbon will produce $80 \times 3.66 = 292.8$ parts CO_2 and will have consumed, $292.8 - 80 = 212.8$ parts of oxygen.

Hydrogen: $2\text{H} + \text{O} = \text{H}_2\text{O}$, i. e., 2 parts of hydrogen give 18
 $2 + 16 = 18$
 parts (1:9) water on combustion. Burning 5 parts of hydrogen
 will produce $5 \times 9 = 45$ parts H_2O and will have consumed $45 -$
 $5 = 40$ parts of oxygen.

Sulfur: $\text{S} + 2\text{O} = \text{SO}_2$, i. e., 32 parts sulfur give 64 parts (1 :
 2) sulfur dioxid gas on combustion. Burning 2 parts of sulfur
 will produce $2 \times 2 = 4$ parts of SO_2 and will have consumed $4 -$
 $2 = 2$ parts of oxygen in the process.

We have then as products of combustion:

| | |
|------------------------|-------------|
| Carbonic acid gas..... | 292.8 parts |
| Water | 45 parts |
| Sulfur dioxid..... | 4 parts |
| | Total |
| | 341.8 |

parts waste gases per 100 units of coal burned.

This involved the consumption of:

| | |
|---------------------------------------|-------------|
| Oxygen for CO_2 | 212.8 parts |
| Oxygen for H_2O | 40 parts |
| Oxygen for SO_2 | 2 parts |
| | Total |
| | 254.8 parts |
| Of this oxygen the coal supplied..... | 7 parts |
| Oxygen from the air, therefore..... | 247.8 parts |

The proportions of nitrogen and oxygen in the air are 23 of
 oxygen to 77 nitrogen by weight (1:3.33). $247.8 \times 3.33 = 825$
 parts of nitrogen which was brought in with the necessary oxygen.
 The total combustion products, therefore, from 100 parts of the
 coal are, $341.8 + 825 = 1,166.8$, the nitrogen constituting much
 the larger part.

The heat which these several gases can carry out at any ob-
 served chimney temperature is found by multiplying each one by
 its specific heat and the observed temperature. For instance, at
 1000°C .,

| | | |
|-------------------------|-----------------------|---------------|
| (CO ₂)..... | 292.8 x .217 x 1000 = | 63537.6 |
| (H ₂ O)..... | 45 x .48 x 1000 = | 21600 |
| (SO ₂)..... | 4 x .15 x 1000 = | 600 |
| (N)..... | .825 x .244 x 1000 = | <u>201300</u> |
| Total | | 287037.6 |

calories which the waste gases from 100 pounds of coal can carry out as sensible heat at 1000° C.

Aside from the sensible heat which is carried out in the water vapor and for which allowance has already been made, there is also its latent heat to be taken into account. At 100° C., this amounts to 537 calories. To raise the temperature of the water from 0° to the boiling point, 52 out of the 100 total heat units are still unaccounted for. $537 + 52 = 589 =$ latent heat per unit of water vapor. 45 parts of water hold as latent heat $45 \times 589 = 26,505$ calories. Therefore the total heat loss is,

| | | |
|--------------------------------------|----------------------|-----------------|
| In sensible heat of waste gases..... | 287037.6 heat units. | |
| In latent heat of water vapor..... | 26505.0 heat units. | |
| Total | | <u>313542.6</u> |

calories for every 100 pounds of coal burned. And from this same amount 479,512.4, ($793,055 - 313,542.6$) calories only are available. It is thus seen that 39 per cent of the heat evolved is lost in the waste gases.

Under practical firing conditions, it is well known that it is impossible to burn fuel without bringing into the furnace much larger quantities of air than are necessary for perfect combustion. This is true because of the lack of admixture of the air and fuel even under the most favorable conditions. The combustion of coal is seldom carried on with an excess of air less than 100 per cent, and often much more than this. To complete the foregoing example, and to illustrate the increase in the waste of heat, suppose an air excess of 75 per cent, that is, there is continually passing through the furnace one and three-fourths times as much air as is required to burn the fuel. To be added

to the heat loss given in the foregoing calculation are, therefore,
 $.75 (247.8 + 825) \times .237 \times 1,000 = 190,690.2$ heat units taken up by the extra air. This makes a total of $190,690.2 + 313,542.6 = 504,232.8$ heat units lost in waste gases. There is in this instance a loss in the gases of over 63 per cent of the total heat generated.

Where it is neither desirable nor necessary to have a large excess of air passing through the fire, the incidental losses in the flue gases may be held much lower by careful methods of firing. The work of the mechanical stoker is to facilitate combustion by so distributing and proportioning fuel and air that complete oxidation is accomplished with the minimum amount of air. The large reduction of the available heat from a fuel with increased air supply has been shown in the preceding problem. To gain direct information as to the air leaving a kiln or furnace, it is necessary to analyze the flue gases. The most approved gas analysis apparatus depends in its operation on the absorption of the several different gases by as many separate liquids through which the gases are passed. By means of the Orsat apparatus, which is a standard type, the proportions by volume of carbon dioxid, carbon monoxid, oxygen and nitrogen may be determined. The air excess is obtained from these data as illustrated in the following:

ANALYSIS OF FLUE GASES.

| By Volume. | Per Cent. | Vapor Density. | By Weight. | Per Cent. |
|--------------------|-----------|----------------|-------------|--------------|
| | | | 3.08 | |
| (CO ₂) | 14 x 22 = | 3.08 | <u>9.15</u> | = 33.66 |
| | | | 5.67 | |
| (N) | 81 x 7 = | 5.67 | <u>9.15</u> | = 61.69 |
| | | | .40 | |
| (O) | 5 x 8 = | .40 | <u>9.15</u> | = 4.37 |
| | | <u>9.15</u> | | <u>99.99</u> |

The weight of nitrogen, 61.69, represents the total amount from air. $61.96 \div 3.33 = 18.61 =$ quantity of oxygen from the air. $18.61 - 4.37 = 14.24 =$ quantity of oxygen used in combustion. $4.37 \div 14.24 = 30.69$ per cent of air excess.

With the composition of the waste gases known, the quantities of heat carried out by them may be calculated by the methods given above. Analysis of the waste gases thus serves as a check on the efficiency of the firing.

PRACTICAL CONSIDERATIONS.

The preceding discussion has called attention to the fact that whether a fuel be high or low in actual calorific power, its heating value depends largely on the conditions under which it is burned. If measures are taken to reduce in the greatest possible degree all unnecessary dissipation of heat, an approach can be made towards attaining the maximum heating power of the fuel employed. Thus the method of burning, the appliances for regulating the air supply and bringing it into contact with the fuel in correct proportions; and, further, the delivery of the fuel itself into the fire box, become of equal and even paramount importance to the calorific power.

The typical methods of burning solid fuels are three, viz., flat grate bar furnace, inclined grate bar furnace and dead bottom fire.

The flat grate bar is by far the commonest in the clay industry. The grate is placed in a horizontal position and the air for combustion comes from below through the bars and the layer of fuel. Since the supply of air is thus obtained, the layer of fuel is always relatively thin to allow the passage of the air. Because of the thin layer of fuel, there is a great tendency for the fire to burn through in holes which let strong currents of cold air into the kiln, if the fire is not constantly watched and attended to. In this respect it is more sensitive to careless firing than

the other methods. It can, however, be made to yield the highest possible heat efficiency and perfect combustion if care is given to it.

When ordinary soft coal is fed into a heated furnace, the first stage in its consumption consists in the expulsion of volatile gases. These are largely hydrocarbons in coal and are combustible. The combustion in a flat grate fire box can be so regulated that these gases are all consumed and add their heat of combustion to the kiln. That is, by gauging the thickness of the layer of fuel on the grate and by feeding constantly small quantities well distributed over the grate surface, the air passing through the burning coal will be sufficient to oxidize the escaping gases as they leave the fresh coal. Perfect firing, therefore, would keep up continuously a smokeless fire, for smoke from the chimney means free carbon and carbonaceous gases, fuel ingredients, ruthlessly and wastefully thrown into the atmosphere.

The layer of fuel is sometimes thickened either carelessly or in an effort to prevent the fire burning through in holes. Such procedure invariably brings about a lowering of the efficiency of the furnace. So long as the fuel is thin and the air thus has free passage in sufficient quantity for perfect combustion, the resulting flue gases are all completely oxidized, the principal products being CO_2 and H_2O . Thickening the fuel restricts the free flow of air through it and the CO_2 formed at first contact with the incandescent carbon is reduced to CO gas and free carbon, which escape with consequent loss of heat. This reaction always occurs when the air passes through a thick body of heated fuel and of itself not only throws partially combusted gases into the atmosphere but prevents the oxidation of the volatile gases driven off when new coal is added. The loss by recarbonization of CO_2 may be partially prevented by a secondary supply of air from the mouth of the furnace over the fuel, but

it is much more difficult to regulate such a supply than to take all the air from beneath and regulate the thickness and continuity of the layer of fuel.

A useful accompaniment to the horizontal grate is the so-called coking plate. The coking plate is made of heavy sheet iron or fire clay slabs, and upon it the fresh fuel is placed before it is charged into the combustion portion of the furnace. It is heated by radiation from the burning coal on the grate. The fresh fuel placed on this plate is subjected to a temperature sufficient to distill the volatile hydrocarbon compounds from it. These gases are slowly evolved, and as they pass over the fire are entirely burned; while if the fuel be charged directly into the highly heated part of the furnace a large share is lost in the smoke. When nothing but the fixed carbon, or coke, remains the charge is fed to the fire.

The position of the coking plate is usually in front and sometimes in front of and above the grate. In either case, radiation from the burning fuel drives off the volatile gases before combustion begins. The area of the plate depends on the fuel used, usually about one-third of the grate area. The operation of the coking plate furnace consists in keeping a supply of fuel always on the coking plate and feeding the fire only with that fuel which has already been subjected to the coking process. The economy of the coking plate lies in the saving of heat from the combustion of the volatile constituents, much of which is ordinarily lost. This is especially important in burning soft coals and lignites, all of which are rich in volatile compounds. There are numerous patent coking furnaces on the market. The principle of all is the same, the variations being in the details of construction. Some, instead of having but one plate, are made with two or three, which are alternately charged with fuel.

The inclined grate furnace differs from the last in having the grate bars set on a slope downwards from the opening into the

furnace. They do not extend to the back wall of the furnace, but are supported by cross bars, one at the furnace door and another six inches to one foot from the bottom of the ash pit, depending on the slope at which the bars are set and the depth of the furnace. The bars are frequently made of ordinary gas pipe, which serve the purpose well.

In operating the inclined grate bar furnace, the fire is first started on the bottom beyond the ends of the grate bars. Fuel is constantly added as the fire grows, until it reaches and covers the grate. There is usually no door to the fire box and the inflow of air through this opening and through the bars is restricted by the heaping up of the fuel alone. When the fire is first started, therefore, the volume of air entering the kiln is very large and becomes less and less as the burning progresses. The ware in the kiln is, however, gradually prepared to stand the increasing temperature which results from the restriction of the air supply and the larger quantities of fuel. When the opening into the fire box is entirely or partially blocked with fuel the air for combustion must pass through the grate and the layer of fuel. Previous to this stage, the volatile gases are largely consumed by the air which comes in over the fire. From the nature of the method, draft will be most brisk through the fuel which is on the grate and slight through that heaped up at the back of the fire box. The partially combusted gases which are thus being constantly distilled from the latter will be more or less completely oxidized before passing into the kiln according as the amount of air gaining access through the grate and over the fire is ample or deficient.

Because of the thick layer of fuel, there is little danger of the fire burning through in holes, and when on full fire the inflow of air is easily regulated by fuel in the door of the fire box. While the firing does not allow of as careful adjustment as on the flat grate bar, this method is not so susceptible to poor and unskilled

firing as the first. Much less care is required to keep the grate free from clinkers, and this relieves the kiln from becoming periodically chilled by the cold air which rushes in during this operation with the flat grate. On closing, however, there is always a considerable amount of fuel still in the furnace from which gases, some of which, as sulfur gases, are detrimental, pass into the kiln for a long period of the cooling. This is likewise true of the dead bottom fire.

Dead bottom firing is done without the use of grate bars. The furnace is constructed with a front ash pit opening for draft, and one from above for the admission of fuel. Provisions are made for secondary air supply by a small aperture leading into the neck of the furnace.

The fire is started in the base of the ash pit against a temporary blocking of loosely piled brick in the ash pit door. The other openings are closed and no air is admitted except from below until the fuel is heaped above the top of the ash door. From this stage on, fuel is charged from above and extra air is supplied over the fire. As the coal accumulates in the fire box the draft through it becomes less and more air is admitted from above. If the coal forms a spongy, viscous clinker, there is a tendency for the latter to assume an incline similar in position to the inclined grate bar, and if the clinker is sufficiently rigid and porous, to serve the same purpose. If the clinker is too fusible or lacking, the coal does not give satisfaction by this method of firing.

Owing to the density which a large mass of fuel will attain when burned in this way, the air passing through the fire in the later stages of burning is not ordinarily sufficient for complete combustion. This condition is sometimes remedied in some degree by repeatedly making holes through the fire from below. Considerable amounts of unoxidized fuel gases, however, continually pass into the kiln. Whether or not the effects of such

gases are detrimental depends on the character of the ware in the kiln. Wares in which it is desirable to have a uniform color, such as stoneware and ordinary building brick, for example, would be injured by such firing; while paving brick and flashed building brick are probably improved in many cases by alternating oxidizing and reducing conditions.

There is little expense for repairs in the use of the dead bottom furnace and any grade of coal may be used, providing it possesses the necessary clinkering qualities. This method is even less susceptible to unskilled firing than the inclined grate bar process. It is, however, poorly suited to the burning of wares that suffer from changes in the character of the kiln gases, either during burning proper or during cooling. The fuel in the fire box at the end of the firing continues for hours to send into the kiln sulfurous gases which often, and especially in glazed wares, produce very deleterious effects.

CHANGES WHICH OCCUR IN THE BURNING OF CLAYS.

The changes which take place in clays during burning may be classed under two heads, chemical and physical. The relation between these two classes of changes is that of cause and effect. The physical character of the clay is altered through chemical processes. The real basis of burning is, therefore, the carrying out of certain chemical reactions which when complete render the clay permanent in form and resistant to disintegrating agencies.

The chemical changes that clays undergo in burning are essentially the same for all clays with only minor variations that may come about by the presence of certain uncommon impurities. The temperatures at which these reactions occur are likewise fairly constant though they may be influenced to some degree by the composition of the clay and the fire gases. Certain of the various chemical reactions that universally take place in clay

burning characterize different stages of the progress. A set of reactions is begun and practically completed before another set is initiated. These changes are sufficiently distinct that the whole burning process may be divided into three stages, viz., dehydration, oxidation and vitrification.

It has already been shown under the chemical properties of clays that the water which they contain exists in two forms, free and chemically combined. That portion which exists free when the clay reaches the kiln is usually small in amount and if the ware is bone dry is known as hygroscopic water and will not be over three per cent. The combined water ranges from 13.9 per cent in pure kaolin to 4 or 5 per cent in impure clays.

Dehydration is a term which expresses the process of driving from the clay all the water it contains. It occurs at temperatures below a bright red heat and is practically complete at 700°C. The first heating of the clay begins to remove the hygroscopic water and this is all expelled when the temperature has raised to a little beyond the boiling point. The amount of this water is so small that there is usually no difficulty in expelling it, providing the heat is not raised too rapidly and a good circulation is maintained through the ware to remove the evaporated moisture. By too rapid heating the moisture is changed to steam while still in the pores of the clay, and "popping" will sometimes result from this cause. Aside from the liability to burst the clay, there is little danger of injury by rapid heating up to the point where the combined water begins to go. From boiling up to 550°C., just beginning red heat, the temperature may be elevated rapidly without possibility of injury.

Another essential in the removal of the free water is the maintenance of a large excess of air in the kiln. If the draft is restricted the air may become saturated with water and condensation take place. As the air passes through the kiln its humidity increases as it approaches the stack; so that if the saturation

point is reached, condensation of the moisture will take place on the ware nearest the exit of the air. In the up draft kiln moisture will be deposited on the upper tiers of ware; in the down draft, on the bottom rows of brick. This deposit is sometimes sufficient to soften the clay, but the ware seldom loses shape from this cause unless by prolonged condensation on the lower tiers in the down draft kiln. This ware is under heavy pressure from the weight of the clay above and will suffer deformation more easily than the top clay, which is not subjected to such weight. In this connection it is of interest to note that the first clay to dry in the up draft is in the bottom of the kiln; while in the down draft kiln the drying takes place from the top downwards. The most rational method of expelling the water from the clay is apparently by an up draft, as in this case the lower tiers, which bear the weight of tons of superincumbent ware, are first rendered firm and strong; and condensation taking place on the top layers is not apt to cause the clay to crumble unless the deposition is excessive. In pursuance of this idea, arrangements are sometimes made in down draft kilns to carry on the early stages of heating up by an up draft, allowing the gases to escape through the crown openings; after which the burning proper is carried on by reversing the direction of movement of the gases.

A more flagrant result of condensation, and one which occurs more frequently, is scumming or whitewashing of the clay. Owing to the universal presence of sulfur in bituminous coal, sulfurous gases always result from its combustion. Wood is free from sulfur, and for that reason is sometimes employed in watersmoking. These sulfurous gases are absorbed by the condensing moisture and the dew which settles on the surface of the clay is always an acid one. Among common clays, there are few that do not contain some compounds which will be attacked or dissolved by such an acid dew. On the later evaporation of the dew the substance formed by the attack of the acid on the

salts of the clay remain on the surface as a scum or efflorescence. Lime salts, both the sulfate and carbonate, are most apt to be affected in this way, and are the most common cause of white-wash which is brought about in the kiln.

After successful expulsion of the water is accomplished, no further change takes place until low red heat is attained and the temperature can be rapidly raised to this point. Here the combined water commences to leave and is therefore another place where caution is required to bring the clay through without injury. This is the "watersmoking" period of dehydration, and is completed with an increase of about 150 degrees of temperature. It has been found by experiment that all of the combined water is gone when a bright red is reached, if the heat has been properly raised.

There is a variance of opinion among investigators as to the effects of expelling the combined water too speedily or too slowly. Too rapid expulsion is thought in some cases to cause puffing of the clay but this seems scarcely possible as the clay at this heat is still porous and offers little resistance to the water vapor as it leaves the clay. If we could believe that some of the water still lingers until the outside of the clay is sealed by vitrification, swelled ware might be accounted for in this way. It is, however, true that wet ware placed in the kiln will often come out badly bloated, while dry ware of the same clay will be perfect under the same firing conditions. Since, as is believed, all water is expelled at red heat, the bloating of the wet clay may possibly be due to the influence of the water in the clay on the expulsion of other gaseous ingredients that are the real cause of the bloating.

The other gases that exist in clays and which are partially or entirely driven out in dehydration, are: CO_2 , from lime and iron carbonates; SO_2 , from iron sulfid; along with the gases which result from the charring and combustion of the carbonaceous

compounds from vegetable matter in the clay. These begin to go at red heat, before the water is all expelled, and some of them are not entirely driven out until long after the dehydration period is passed. The slow expulsion of the water retards the expulsion of the other gases some of which may remain in the clay until the rising temperature has sealed the outside by vitrification and thus indirectly aid in producing bloated ware. Just what gases remain in the clay to this elevated temperature is not certainly known. It is believed that CO_2 from the carbonate of iron and SO_3 from lime sulfate may thus become entrapped and swell the clay. It has been further suggested that oxygen set free by the reduction of ferric oxid to the ferrous condition may be the cause of bloating, since this phenomenon is nearly always accompanied by such reduction. It is evident that any gas that may be generated in the interior of a body of viscous clay would produce the bloated condition with which clay workers are all familiar.

It is known that the carbonate of lime or of iron and the sulfates will not break up readily and evolve their respective gases if the atmosphere which surrounds them is already charged with these gases. The expulsion of water vapor is similarly influenced. Hence in a kiln already filled with combustion gases and water vapor the tendency is least for the clay to yield the gaseous compounds which it is desirable to get rid of. The character of the fuel gases depends on the kind of fuel employed and the draft. The more the fire gases are diluted by the admission of air, while still continuing a gradual increase in temperature, the more favorable are the conditions for the removal of gases from the clay. The removal of carbonaceous combustible material is likewise favored by an excess of air, which means strongly oxidizing conditions.

The water smoking period is best conducted, therefore, with plenty of air to dilute the fire gases and remove the water and

other vapors that are beginning to leave the clay. The ideal fuel for use during the whole dehydration period, and especially during the earliest stages, is one free from sulfur and as low in water as possible. Soft coal, the commonest of fuels, contains as high as 3 per cent of sulfur and appreciable amounts of water. Wood is free from sulfur but on combustion furnishes large amounts of water vapor. The injurious effects of sulfur are as a rule apt to be seen only when the latter is accompanied by an excess of water. Similarly, the water will do no harm ordinarily in the absence of sulfur. Bituminous coal is, therefore, the worst of fuels in this respect. Wood is better because it lacks the sulfur and for this reason is the best obtainable fuel for water smoking. Coke and charcoal are excellent, the latter being the theoretically perfect fuel as it is free from both sulfur and water; but their use is not in most places economically feasible.

It is clear from what has been said that the proper regulation of the draft is a matter of great importance during the period of dehydration. The freedom of air circulation to be permitted through the kiln is determined by the kind of fuel employed and the percentage and nature of the gaseous constituents to be expelled from the clay.

It has been pointed out that certain reactions other than that of dehydration set in during the latter part of the first period. These reactions, chief of which are the burning out of organic matter, of the sulfur from sulfids in the clay, and the decarbonization of carbonates, are completed in the second, or oxidation stage of burning. It has also been shown that any retardation or incompleteness in the expulsion of combined water may hinder the later and perfect removal of the other gases and result detrimentally to the ware. This points to the conclusion that each stage must be conducted as nearly separate from the succeeding one as possible. The characteristic reactions of the first stage

must be executed most expeditiously and completely before those of the second are allowed to take place.

The second is termed the stage of oxidation, since the prevailing changes that occur are processes of combination with oxygen. The oxidation of combustible matter in the clay is completed, the sulfur from sulfids disappears, and iron which exists in the clay in any of the lower states of combination is altered to the red or ferric condition. This latter reaction gives to common clays their red color and is the most important phenomenon occurring during this period. On the successful completion of this reaction depends to a great degree the perfection of the ware especially if it is to be vitrified.

If the clay contains combustible matter, as a great many of the shale clays do, it is impossible to bring about oxidation changes in the iron until this is all disposed of. As formerly stated, carbonaceous compounds which exist naturally in the clay produce the same effects in burning as so much fuel artificially mixed therein.

It begins to burn at a low red heat and will disappear by the close of the first stage unless present in excessive quantity. In the latter instance, it may even be necessary to stop firing and close the kiln tightly for several hours, admitting only the air that filters through the kiln walls and around the fire holes, in order to prevent the rapid combustion of a large amount of fuel at just the time when it is imperative to raise the heat very slowly. This is an unusual case, and such procedure will seldom be found necessary. In all clays, however, that contain any carbon the iron exists in the ferrous state in the raw clay and for this reason must always be oxidized in the kiln. In some weathered shales and most surface clays oxidation of the iron is either partial or complete in nature and is not an important reaction in burning. Such clays are more easy to burn than those in which all oxidation must be done in the kiln.

The process of oxidation begins in the later stages of dehydration, 500 to 600 degrees C., and should be complete at 900 degrees. For the average run of clays it is complete at 750 or 800 degrees, and in those clays that vitrify readily it is especially essential that oxidation be finished at as low a temperature as possible. The oxygen for this reaction comes from the atmosphere, whether it is accomplished in the bank or in the kiln. In the former case the process is a slow one but may be just as complete as that accomplished in the kiln at high temperatures in a few hours. The amount of oxidation required then depends upon the character of the clay.

The compounds of iron most commonly found in ferrous clays are iron pyrites, FeS_2 , and the carbonate, FeCO_3 . FeS_2 loses one atom of S at about red heat, but holds the other to a higher temperature, when it finally breaks up and the iron is oxidized. FeCO_3 loses CO_2 at a strong red heat, becoming FeO . Both of these compounds are thus reduced to ferrous oxid, and whether or not they are then changed to the red ferric oxid depends upon the kiln atmosphere from which they must obtain the necessary oxygen. If this oxygen is present in large amounts, i. e., if there is passing into the kiln an excess of air and the carbon of the fuel is largely burned to CO_2 , the conditions are favorable to oxidation of the iron. If, however, the flow of air is restricted and there is passing into the kiln quantities of CO and unburned hydrocarbons, themselves greedy for oxygen, it is very evident that no oxidation of the clay can take place, the tendency of these gases being rather to remove or withhold what little oxygen is present than to supply it. A smoking kiln indicates a reducing fire; a clear one, an oxidizing fire.

In the presence of an ample supply of air the ferrous oxid produced by the decomposition of the sulfid and carbonate will at once pass to the red ferric oxid, and when this reaction is complete the oxidation stage is safely passed. If the supply of oxy-

gen is just sufficient for the combustion of the fuel in the furnace, none remains for the combustion of the iron in the clay, for the latter is truly a process of combustion, the oxid formed remaining as a solid instead of passing out a gas. If the air supply is deficient, that is, insufficient for good combustion, and volumes of heavy smoke emanate from the stacks, oxidation is not only checked but the reduction of oxids already existing will take place.

Ferrous oxide, FeO , is a very violent flux at high temperatures, and if the requisite oxygen for changing it to ferric oxide, Fe_2O_3 , is absent, it will enter into silicate combination with the clay. The result of such a combination is bloated, deformed and even slagged ware. This reaction is less apt to occur the lower the temperature, hence the desirability of completing oxidation as early as possible. If once changed to Fe_2O_3 , the tendency to reduce to FeO by a period of reducing fire is greatly decreased. It is the nascent FeO that is most apt to do damage.

With the above noted influences of the character of the kiln gases in mind, it is plain that the readiness with which they are able to accomplish their work is dependent on the structure of the clay. A close-textured, fine-grained clay affords less easy access to interior portions than a coarse-grained, open-textured one; for the oxidation of a mass of clay can only proceed from the surface inward by actual circulation and contact of the hot gases with the oxidizable minerals.

The importance of thoroughly completing this stage of the burn before the last stage is allowed to begin will now be apparent. When this stage is completed a common brick will show red color to the center when broken. If it is banded or has a core different in color from other parts, it is incomplete. This stage completes the burn for ordinary building brick, but it is even more important to have oxidation complete in ware that is to be vitrified than in such as matures at this point. The state of

affairs in a burning kiln may be ascertained by drawing a test brick from a part of the kiln in which the process progresses slowest. If this is perfect it is safe to assume that the whole kiln is in a similar condition.

The detrimental effects of the imperfect carrying out of the work of this stage are likewise apparent. If the temperature is raised to vitrifying heat before oxidation is complete, the FeO in the center of the brick will combine, giving the black, slaggy core, an element of weakness. In case the work of dehydration has not been properly executed, the iron may still retain its CO₂ at this heat. When it does finally decompose, the ware is already softened by vitrification, no oxidation is possible, and to the slagging effects of the ferrous oxid in the middle of the brick are added the puffing, bloating effects of the enclosed and expanding gas.

The term vitrification is given to the last stage of the burning process. The word itself means conversion into a glass or glassy condition. As used in connection with the burning of clays the word has come to have a somewhat restricted or specialized definition. The manufacture of glass consists in melting together mineral substances to a condition of perfect fluidity such that when the mixture is properly cooled it will possess a homogeneous composition and an amorphous structure. The physical conditions surrounding a vitrifying clay, and the ingredients of clays themselves, are similar to those obtained in glass production. But the process of heating and consequent fusion of these ingredients is not carried as far in the kiln as in the glass pot. As a result what would be called a thoroughly vitrified clay does not have a homogeneous composition and its structure is more or less crystalline; its partially crystalline condition being due in part to incomplete fusion and in part to recrystallization on cooling.

Vitrification means, therefore, the beginning of chemical combination of the minerals of the clay with each other. During the two preceding stages, chemical changes have occurred but they were limited to the breaking up by the advancing heat of compounds already existing in the clay and the combination of certain elements with the oxygen of the kiln atmosphere. After these are all complete, combination among the constituents of the clay begins and becomes more and more complex as the temperature rises. If carried far enough most clays will be finally reduced to a fluid glass. It is clear that the composition of the clay determines the complexity of the vitrifying reactions, the readiness with which fluidity is attained and the temperatures at which these reactions take place. There is always a stage in the fusion of a clay that is capable of melting, beyond which if the temperature be raised the clay will lose its shape. It has been found that with some clays this line can be more closely approached than with others. This depends on the proportions of the various fluxing elements in the clays as explained under Fusibility of Clays. Experience has also proved that from those clays which can be successfully handled in the kiln at temperatures of vitrification, will result the better final product the more complete the vitrification is, that is, the more nearly the condition of the clay can be brought to the state beyond which it would settle out of shape. If the vitrification is not carried this far the clay will be porous and possess low wearing qualities. Carried beyond this condition, the ware is brittle. Just at this point, the clay can be so cooled as to produce a ware of maximum toughness, minimum porosity and, therefore, of most permanent quality, for the clay used. It is this condition to which the term vitrification is applied.

When combination takes place among the minerals of a clay the identity of each is gradually lost until finally they are all so amalgamated into one another that separated minerals can

no longer be distinguished. On the completeness of this amalgamation and the resulting degree of softening of the clay as a basis, some have divided the process of vitrification into stages. *Incipient* vitrification is attained when the particles have begun to unite but while their identity is still fairly distinct; when the porosity is not over two per cent; and while the fracture would not yet be vitreous or glassy. The ware has about reached its maximum strength and is in the condition to which many of the best vitrified paving brick are burned. Between incipient vitrification and the last stage, which is called *viscous* vitrification or fusion, is a range in temperature of from one hundred to four or five hundred degrees F., according to the clay. During this interval the clay particles, with the exception of the larger sand and other refractory grains, entirely lose their identity and the original structure of the clay disappears. The clay reaches its limit of shrinkage, and becomes practically non-porous as it gradually passes into the viscous state. This condition before viscosity, or actual flowage, begins, is termed *complete* vitrification. It is the limit in burning vitrified ware. If cooled quickly, even in this thoroughly vitrified condition, the ware will be brittle, while if properly annealed by slow cooling, a perfectly tough and strong ware will be produced. The effort of burners is to attain complete vitrification without passing over the border line into viscous vitrification and fusion. It is very evident, though, that with any clay no definite or fixed lines can be drawn between these several stages, as each gradually passes into the succeeding one. The rapidity, however, with which these transitions progress vary widely among different clays and control more than any other factor the availability of clays for the manufacture of vitrified wares.

Just what the reactions of vitrification are can not be stated. Little more can be said than that they are combinations of the bases or fluxing compounds with the acid elements of the clay

to form silicates. The bases become active according to their relative fusibilities and, in a general way, influence vitrification in proportion to their molecular weights. The temperature at which vitrification occurs is likewise variable, being also dependent on the composition of the clay. In some of the more impure clays vitrification begins at 900°C., while some clays used in paving brick manufacture require upwards of 1200° for good vitrification.

The regulation of the firing conditions during vitrification is not especially difficult, providing the work of the two preceding stages has been properly executed. If the clay is thoroughly oxidized and of a uniform red color throughout the cross section of the thickest piece of ware, there is little danger of trouble in the last stage unless the kiln is excessively over fired. The vitrification changes take place gradually with the rise of temperature, and without especial dependence on the character of the kiln gases. Of course, a period of strongly reducing conditions will begin to change the iron back to the blue, ferrous form, but as the clay has already lost a large percentage of its porosity this reduction can go on but very slowly and, unless this period be long continued, can do little harm. To engineers the dark brown color of pavers is often an indication of superior quality, and manufacturers sometimes adopt the use of a salt glaze to give the desired appearance. This expedient is not ordinarily necessary, as a superficial "skin" of the dark, ferrous brownish-black color can be produced by a brief period of reducing conditions just before closing the kiln. The cross section of such brick shows a uniformly red color, coated with a layer of brown. The thinner this outside layer is the better, as it adds nothing to the wearing quality of the brick. The farther into the brick such reduction progresses, the more brittle the ware is apt to be. Vitrified ware that is salt glazed, e. g., sewer pipe, are found to take and retain a smoother glaze if superficially reduced just

before the salt is applied. This is especially useful in the destruction of whitewashes which materially prevent the attachment of the glaze.

The most common defect observed in vitrified wares is black cores, which are frequently puffed or vesicular. It has been pointed out that the cause of this is the lack of thorough oxidation, and that it is in no degree attributable to the firing conditions during vitrification. Remedial measures should therefore be adopted before this stage is reached. Excessive over-firing will of course finally melt the clay, but if it is one which is low in lime and contains good percentages of iron and the alkalis, vitrification is slow, and only the grossest mismanagement can ruin the ware. Under-firing is more common.

On completion of the oxidizing stage of the burn, the large air excess which has heretofore been necessary is greatly reduced and an increase in temperature is at once produced. The exemplary kiln for burning vitrified wares is the down draft. Because of the rise in temperature, the top brick soon begin to take on the changes of vitrification. The problem from this point on is to carry this heat downwards through the ware to the bottom of the kiln without over-burning the top courses. When the top ware is heated to about the maximum temperature it will stand the air inlets are opened and the gases are cooled somewhat as they pass into the kiln. When they reach the top brick, which now have a temperature higher than the gases, heat is absorbed from these brick and carried downward through succeeding courses. After a brief period the air access is cut off, the top courses again heat up to a maximum, and another in-flow of air is permitted, which carries the heat, each time this is repeated, farther down into the kiln. Such a procedure is necessary to prevent overburning of the top brick while those below are in zones progressively brought up to the required temperature. Each alternation in the flow of air sends a wave of cooler gas into the kiln, which takes its maximum temperature from the upper tiers

of brick and each time extends the zone of highest heat a step towards the bottom of the kiln. Even under these apparently favorable conditions, however, the bottom brick are seldom burned as hard as the top, and oftentimes the top brick, while neither distorted nor entirely worthless, are nevertheless somewhat brittle, weak and of inferior quality, due to the alternating heatings and coolings while so close to the melting temperature.

TYPES OF KILNS.

There are various styles of kilns in use in the different lines of the clay industry. The modifications which are found among the individual kilns of a general type are largely those that are necessary for meeting certain peculiarities in clays or to give them certain desired properties in burning, or such as are necessitated to adapt the kiln to the production of a special line of ware. Of the numerous kilns in common use, practically all may be included in the two groups, intermittent and continuous, which, as the terms suggest, are in the one case periodic, and in the other continuous, in their mode of operation.

The intermittent kiln embraces by far the largest number of clay burning kilns in all sections of the country. It is, however, gradually giving way to the continuous kiln for burning many of the commoner grades of ware, as the merits of the latter become more familiar to clay workers. The intermittent kilns may be divided as follows:

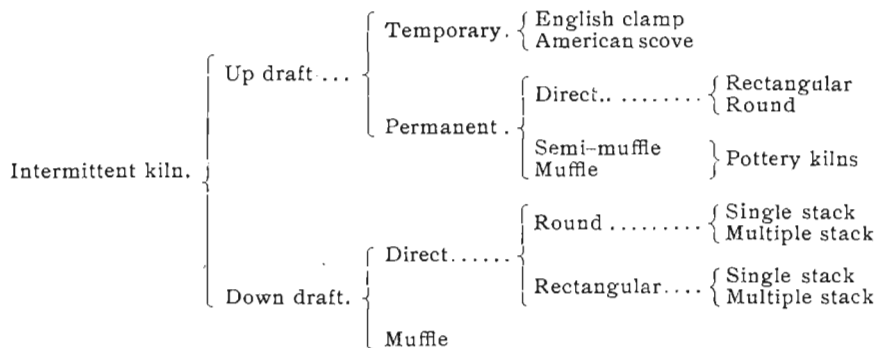

UP DRAFT KILNS.

The temporary up draft kiln is exemplified by the old English clamp and the American scove kilns. In both these types the kiln is built chiefly of the ware to be burned but is commonly walled and covered with burned brick and bats which are kept mudded up to prevent the loss of heat. In the clamp kiln the fuel, which must be pulverized, is charged in layers with the setting of the brick. Low arches at the bottom are also constructed of the green brick and are filled with fuel. The fires are started in these arches, from which burning progresses of itself throughout the kiln. When the fuel which has been included in the ware is consumed, the burn is completed.

This kiln has not met any extended use in this country. The principle is crudely applied in burning clay for ballast at some points in the state. The clay is heaped up by means of specially designed steam shovels into a mound three to six feet high, layers of slack coal alternating with layers of clay. The mound is made of any desired length up to half a mile or so, and of a width depending on the amount of ballast to be prepared; the clay being fired simultaneously along its whole length, and the fire progressing towards the side where the clay and fuel are being piled. In a sense, the process is a continuous one, although it possesses none of the elements of economy to be had in the continuous kiln.

The so-called scove kiln is similar in construction to the clamp kiln but differs in operation, due to the fact that the fuel is not included with the brick, but is burned in arches which serve as temporary fire-places. Since the heat must be carried through the ware by air currents, a more open setting is required than in the clamp, where the brick are set nearly solid.

The permanent up draft kilns are separated into direct and muffle, according to whether the combustion gases pass through the ware, thus heating by convection, or are separated from the

ware by a partial or complete enclosing wall, through which the clay is burned by radiation and conduction. The side walls are built permanently instead of being erected as each kiln is set. The walls are frequently built the total height of the kiln, but more often only eight to ten feet high, the necessary courses above this being added as the brick are set. The top is covered with one row or more of burned brick "plating," which is of course removed as the kiln is drawn.

In these side walls openings are left which lead into arches formed in setting the green brick, and in which the fuel is burned. A further step in the evolution of the kiln is the construction of partial permanent end walls and of fire-boxes in the side walls. One furnace may feed one or more arches. By this improvement the draft is much more carefully regulated and the percentage of unsalable brick immediately around the arches greatly reduced. The permanent kiln wall prevents the loss of considerable heat by radiation and aids in bringing about a more even burn than is possible in the temporary kiln, where the outside brick are always soft burnt and those surrounding the arches are cracked or slagged.

The round up draft kiln is the early pottery kiln, and its use has continued to the present time in the stoneware industry. The kiln consists of a lower combustion chamber into which the fire boxes open beneath a chamber in which the ware is placed. The combustion chamber occupies practically all the space beneath the ware chamber, but the bottom is solid, except those portions occupied by the grate bars of the furnaces, which is a small proportion of the total space. Between this and the ware chamber above is fire brick work, perforated to allow the passage of the gases. The outlet is usually a series of little chimneys leading out through the kiln crown. The work of this kiln is in most cases characteristic. Where the gases are allowed to come into contact with pottery wares in any kiln, flashing is common,

since the clays used are sensitive to oxidation and reduction. So much does this sensitiveness vary, though, that some clays give no trouble whatever, while others that in other respects are suitable for stoneware manufacture, must be discarded because the ware made from them invariably comes from the kiln with flash marks on it. Glazed wares show "bluestoning" when burned in this kind of kiln, probably caused by the reducing action of the gases on the iron in the clay. This peculiarity is seldom noticeable in muffle burned wares.

In its evolution to the modern pottery kiln, the principal changes in this primitive up draft have been such as to prevent more and more the contact of the combustion gases with the ware. The passage of these gases was restricted to the center and the outermost portions of the kiln, the rest of the floor of the ware chamber being solid. Between the moving gases and the ware were constructed bag walls extending around the entire circumference of the kiln. These bag walls are now built to varying heights, from very low to the top of the ware, and even for special reasons completely enclosing the ware. The gases are thus always more or less separated from the ware, which is heated more and more by conduction through the walls as the latter are built higher. To promote a draft through the center of the kiln, the ware is either stacked so as to leave a center opening, or a permanent center flue is provided. The effect of screening the ware from contact with the flames is to do away with flashing. If this protection is partial, as where the bag walls are built but a fraction of the height of the ware, the construction is spoken of as a semi-muffle kiln. Where the muffling is complete, as where both walls and center flue unite above the ware and entirely enclose it, the kiln is termed a muffle kiln.

As soon as immediate contact of the hot gases with the ware to be burned is cut off, the consumption of fuel is greatly increased. It is therefore necessary to have perfect control of the draft, so

as to curtail as much as possible the losses by air excess. The chemical character of the gases becomes of minor importance when they are not allowed to touch the ware. The number of furnaces is increased in this modified construction, and the fire boxes are built and the fuel is fired so as to generate the maximum number of heat units possible. The grates, fire doors and stack are, in improved kilns of this type, under complete control. It is evident that under these conditions careless or unskilled firing can easily entail a high percentage of waste over that which it is impossible to avoid.

DOWN DRAFT KILNS.

Round Down Draft Kilns:--The commonest example of the down draft kiln is the round, single stack kiln. This type is used more than any other in all branches of the clay industry. Modifications of the simple type are many, according to the conditions and clay in different places, but the principles of operation remain essentially the same. The number of stacks is found to vary widely, and the arrangement of the flues leading to the stacks and the openings from the kiln chamber into the flues are points of variable design.

Under an earlier topic the relative merits of the classes of fire boxes in common use have been pointed out. Any of them may be used on the round down draft kiln, but whether one or another is to be chosen depends upon the clay and the ware into which it is wrought. If it is requisite to have the kiln atmosphere uniformly oxidizing, or if the ware is such that sulfurous emanations may be injurious, the inclined grate or dead bottom fire would not be suitable; while either of the latter would be applicable for burning paving brick or other wares that are not injured, and often even benefited, by an occasional period of reduction.

The burning of all wares through which it is allowable for the fire gases to circulate is accomplished by the transfer of heat from the fire by these moving currents. This method of heating is termed convection. It is evident that in all but muffle kilns this is the important means by which the heat reaches the ware. The production of an equal draft through all portions of a kiln of ware is thus an all-important consideration. The flow of

PLATT TRIPLE DRAFT KILN.
Patented.
C. B. Platt Van Meter, Iowa.

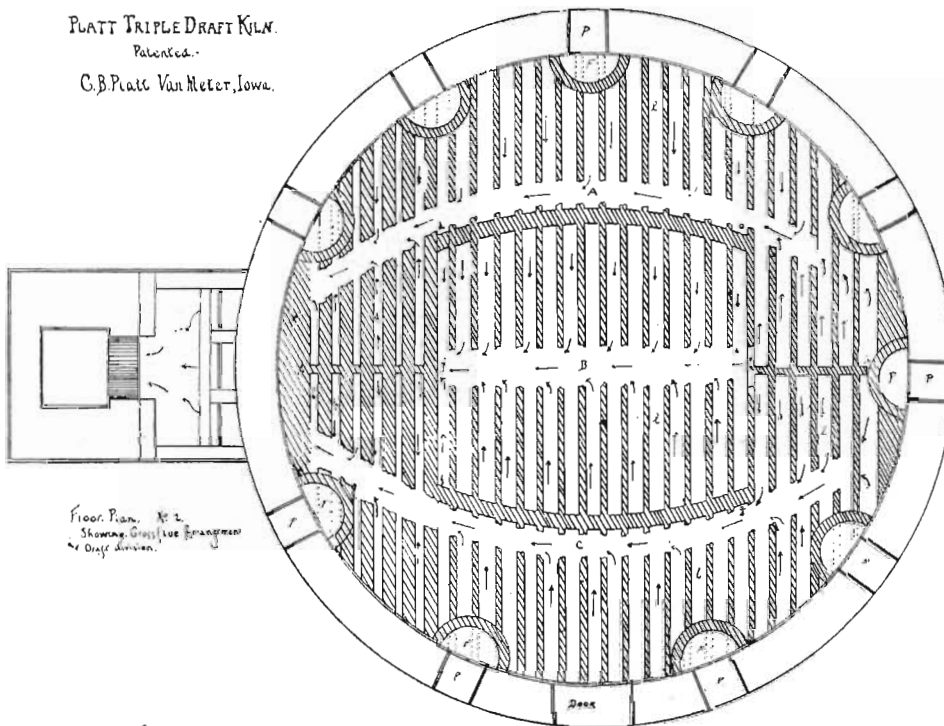

FIG. 27. Floor plan, multiple stack, round down draft kiln.

gases through a kiln is influenced by the same factors as affect the movement of any liquid. If unobstructed they seek the most direct and open way to the exit flue.

The round down draft was first built with but one center draft opening which led to an outside stack. The tendency of the gases was to take the shortest route to this opening from the top

of the bag walls over which they entered the kiln. Parts of the kiln between the bags and the draft opening were left unequally heated, while if the temperature was raised so as to burn these parts properly, the portions in direct line of the draft were over-burned. Such a defect in the working of a kiln is a difficult one to remedy as long as but the one opening is provided. It may be in part improved by methods of setting the ware, but after the kiln is on fire and the direction of the flow of the gases is once established it is a troublesome matter to control. This is true because of the higher temperature in the line of flow, which of itself produces draft, and hence continually strengthens that which is started. In a similar way the draft in kilns with side stacks is apt to be such as to leave the middle portions poorly burned. Experience has shown that an equal distribution of the draft through all portions of the kiln can only be obtained by taking the gases out through openings distributed over the kiln bottom instead of through a single well towards which they will all naturally concentrate.

The evolution of the down draft kiln to the diverse types of the present has taken place largely by modifications and improvements in the flue systems, and in the arrangements for leading the gases from the kiln into these flues. An early step in this evolution was to have in place of the center well-hole one open flue across the middle of the kiln bottom. This flue led to an outside stack. The gases were naturally drawn by the shortest route to this exit. As a result there was produced a highly heated area in the part of the kiln closest to the stack. A further modification was to afford a flue circling the interior of the kiln and connecting with a diametric flue such as was first used alone. This is the principle of the construction of a kiln which is quite popular in some localities at the present time. To prevent extreme concentration of the draft in this kiln the flues are closed for some distance in the part of the kiln nearest the stack. While

of course such a provision serves to retard the more pronounced flow, the tendency for the gases to leave the kiln as near the stack as possible is always present and invariably disturbs the equality of the draft.

A diametric open flue connected with the stack by a covered flue was somewhat of an improvement over the foregoing, but in this

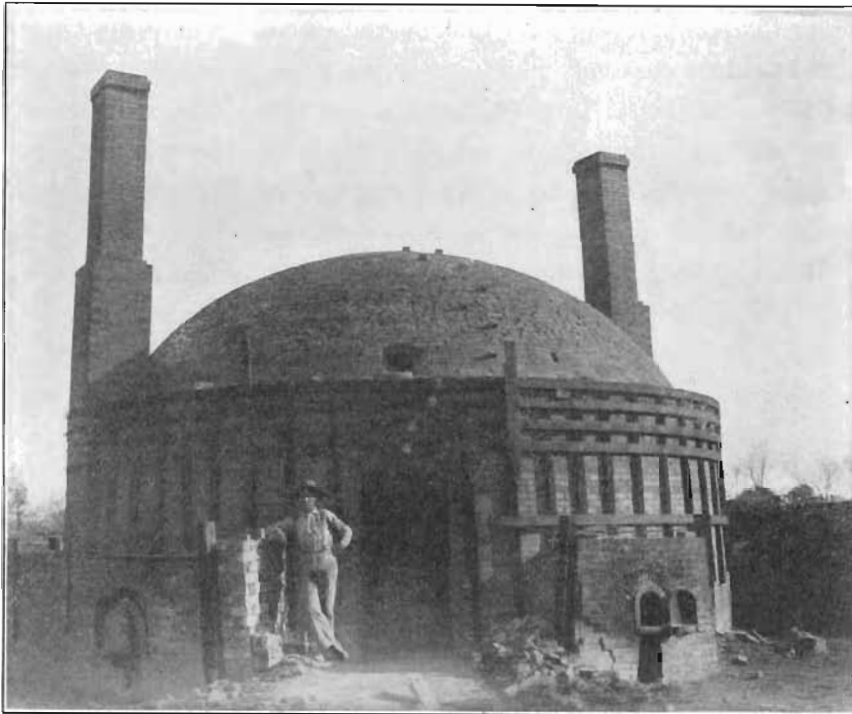

FIG. 28. Round down draft kiln with two stacks.

the draft is, as before, usually strongest in the central parts of the kiln. A series of concentric flues intersecting the main stack flue likewise give far from perfect satisfaction.

It is plain that any arrangement by which the gases are finally removed from the kiln, other than from the center of the bottom, must tend to heat the kiln in spots and not symmetrically with reference to the center. As has been shown, where there is but

one outlet, and that a center well hole, the gases draw directly towards that point. The draft is, however, symmetrically distributed from circumference to center. Although the outer portions receive the least draft, it is alike in all similar parts of the kiln. A means which will operate, therefore, to equalize the draft from circumference to center, must be of such design that portions of the gases will be removed from the ware chamber at points distributed over this intermediate area. These openings must lead into channels which carry the gases to the center stack flue and must be so proportioned in size that an equal volume of air will pass through each during the same interval. In general, they should decrease in diameter towards the center, draft directly into the main outlet being practically cut off.

There are numerous methods of attaining this end. The commonest is by the construction of radial flues outward from the center. The number of these is usually determined by the number of fire holes, the flues bisecting the areas between the bag walls. Occasional openings are made into these flues. The openings are larger the farther from the center, so the outside will draw as strongly as the central portions. The shape of these openings is variable and, indeed, immaterial, and their number is not fixed. The total area of those leading into any one flue should, however, be less than the cross section of that flue. That is, the flue should be able to pass more air than can enter it through these openings. For the same reason, the total area of the radial flues should be less than the section of the main stack flue. The sizing of those openings into the radial flues can be done experimentally. What is desired is an equal air velocity through each and every one. If a draft be produced in the kiln by heating the air column in the stack, the velocity of the air movement in the flues can be measured by an anemometer and the openings so proportioned that the draft will be the same in each, whatever its location.

The above outlined arrangement can be made to give very excellent results and is detailed only as an example of many equally successful designs. Some others are more or less involved in plan but meet success only in the degree to which they fulfil the conditions of an equalized draft. Some special types will be described in the discussion of individual plants.

While it is essential that the kiln be so constructed as to insure a uniform draft, such construction does not necessarily guarantee a perfect draft when the kiln is full of ware and on fire. The setting of the ware has a great deal to do with the draft. A perfect draft in an empty kiln may be very far from such when the kiln is stacked full of brick. In this way a good design may be made to give very inferior results. It is also true that a poor construction can be made to give fair results by the style of setting; but it is much easier to adapt the setting to a kiln which is built on correct principles at first than to remedy an improper construction by the same means. If it is found on drawing a kiln that there have been "cold spots" in it, that is, parts where the ware is underburned, and perhaps in other portions overburned ware, it is a sign of inequality of the draft, especially if these areas are away from the bag walls, where local heating may occur by proximity to the fires. Such defects may be prevented by a closer setting in the lines of greatest heat and more open in the cold portions.

But with a uniform draft throughout the kiln it is very commonly found that the bottom ware is less hard burned than the top portions. This is to be expected from the fact that the heated gases first come in contact with the top ware and must have passed through it before reaching that lower in the kiln. As a consequence, it may be stated as a rule that the gases are always cooler when they reach the bottom than when they entered the kiln. The more rapidly they move towards the outlets, that is, the better the drafts, the farther will their initial heat be carried

into the ware, whether it be greater or less than the temperature of the ware itself. The movement of the gases in a kiln may be conceived as that of a wave progressing downwards through the ware with equal velocity in all parts of the kiln. It will progress thus uniformly until it nears the kiln bottom. Here it must divide into numerous small currents, each diverging more or less from a straight downward path in order to pass out through the openings which convey them into the radial contributory flues. It is clear that the number of these flues must be limited, and therefore between the openings into them there must be areas of solid floor through which no draft is possible. As a result of this splitting, as it were, of the main draft wave into many small currents, the whole movement may be construed as suffering somewhat of a check; this check being least in direct line with the draft openings, and greatest just above the solid portions of the floor. Through the ware situated in these intermediate positions the draft is not vigorous, and as a consequence there is always found underburned ware in kilns of such construction.

It is oftentimes not objectionable to have a proportion of underburned ware in some lines of the clay industry, as it is fully as salable as the hard burned product. It may not in such instances be desirable to eliminate the difficulty just described. What is spoken of as a false floor is provided where it is desired to reduce the loss by underburning to its lowest terms. This floor is sometimes made of the green brick to be burned. The lower courses are set as openly as possible and still afford a firm support for the ware above, and arranged so as to furnish room for a free and unretarded circulation of the gases in reaching the outlets. In this manner the check which the movement of the gases suffers is less pronounced and the number of underburned brick is less than where such provision is not made.

The permanent false floor is a part of nearly all recent down draft kilns, especially those used in burning vitrified wares. In place of a temporary construction of green brick, which must of necessity be removed and re-set with each burn, the floor is made an essential part of the permanent construction of the kiln. It is built of fire brick and so supported with open brickwork as to leave ample space below it in which the gases may circulate unimpeded in finding their way to the flues. The brick of the floor itself are usually of some special design, their shape being such as to permit the freest possible escape of the gases through them and yet possess the requisite strength. The false, or, as it is commonly called, checker floor construction, allows the unretarded passage of the draft completely through the ware with equal facility at all points into the open space below the floor, where it is at liberty to seek out the most convenient avenue to the stack. The ware is thus brought to a substantially uniform temperature to the bottom of the kiln. All the false work of the floor is therefore heated to the highest temperature of burning, and is thus the source of a loss of heat which does not exist where the false floor is built of green ware. The continuous flow of gases, which is facilitated by the use of the checker floor, is an important factor in burning those classes of ware in which flashing is detrimental. The false floor is thus a desirable accessory in the kilns of the paving brick and sewer pipe industries and is also desirable in the manufacture of front brick, although in the latter a good flashed product is often sought after. While in a kiln equipped with the checker floor, flashing is less apt to occur uncontrolled by the operator, it is no less difficult to obtain flash effects in a kiln of this design than where the false floor is absent. All glazed wares can likewise be more successfully burned in kilns provided with the false floor.

The force of the draft through a chimney depends on the difference in weight between the column of hot gases within the

chimney and that of a similar column of the atmosphere outside. This difference in weight, or pressure, is due mostly to the difference in temperature; being influenced also by the humidity of the air in question. From this it appears that chimney drafts may vary not only because of difference in temperature but according to the composition of the gases themselves and the condition of the weather. This difference in weight may be calculated as follows. If D is the density of the air, d of the chimney gas, in pounds per cubic foot, h the height of the chimney in feet, and .192 the factor of relation between the pressure in pounds per square foot and inches of water gauge, the expression for the force of draft in inches of water is.

$$F = .192h(D - d).$$

The densities vary as the absolute temperatures, D and d having values, $D = .0807 \frac{t_2}{t_1}$; $d = .084 \frac{t_2}{t_1}$. t_2 is absolute temperature at 32° F. or 493. t_1 , absolute temperature of the flue gases and t_2 of the atmosphere. Making these substitutions, the first expression becomes,

$$F = .192h \left(\frac{39.79}{t_2} - \frac{41.41}{t_1} \right). *$$

This difference in weight may be measured directly by a draft gauge. The common type of gauge consists of a U-tube partially filled with water, one part of which connects by a tube to the inside of the chimney and the other is left open to the air. Both arms of the gauge may be graduated so the difference in height in the two parts is read directly in inches of water. This device is applicable for making similar measurements in the control of ventilating currents in mines and tunnels as well as for the control of draft in many of the metallurgical industries. An instrument devised more especially for use in the ceramic industries is meeting with much favor among many pottery establishments. This so-called draft-meter consists of a small hermetically sealed

*Kent's Mechanical Engineer's Pocket book, 5th Ed. p. 732.

box of sheet metal which is filled with a liquid. To this box is connected a graduated glass tube on which can be observed the height of the liquid in the box. The instrument is connected with the chimney by a tube leading from the top and joining with a metal tube opening into the interior of the stack. The fluctuations of the draft are registered by the movement of the liquid in the glass tube. Satisfactory use requires arrangements for accurate leveling. The instrument is inexpensive and affords a positive means of draft control which is otherwise impossible. By its use the kiln can be adjusted to atmospheric changes whose influence without it can be little more than vaguely guessed at by the burner. The draft-meter is believed to be a valuable accessory in the burning of all classes of clay goods.

The amount of draft found to exist in kilns is represented by from one-fourth to three-fourths of an inch of water. The energy which produces this draft is the heat which the gases contain when they reach the chimney. The hotter the gases the stronger the draft. In starting a burn it sometimes occurs that the temperature of the gases when the stack is reached is so low that movement ceases and in extreme cases is even reversed in direction. It is therefore important not only that the condition of the draft be known, as shown by a draft gauge, but that means of control be at hand such that a weak draft may be strengthened or one that has failed be restored.

The original construction of the kiln with the flues and stack correctly proportioned to each other is first of all essential. The stack is the real draft producer. It is built of brick or sheet iron. The former is more expensive but in general gives better satisfaction. The thin and readily conducting shell of a sheet iron stack dissipates heat very rapidly by radiation. A sheet iron stack lined with fire brick to prevent radiation makes perhaps the most substantial and serviceable stack although at the same time the most expensive. The cross section of the stack should

decrease towards the top. It is found that this will largely prevent counter currents from flowing in at the top which are a source of greater or less difficulty in straight stacks. The tapering construction does this by gradually increasing the velocity of the gases as they near the outlet by forcing the same volume through a space with a constantly decreasing cross section. The size and height of the stack should always be such that the full capacity will seldom be called into use. That is, it should possess a reserve force which under average working conditions is held in check by the damper but which can be made effective when emergency demands.

The natural tendency of the air and fire gases as their temperature is raised and they expand is to rise. In all up draft kilns this tendency is satisfied by the ready escape to the stack, the movement being always in an upward direction. In the down draft kiln the gases must first move downwards through a mass of ware before they can reach the stack. They must move contrary to their natural tendency and apparently in opposition to gravity. The principle may be compared to that of the siphon. In the latter a fluid heavier than air moves against the direction of gravity for a short distance in order to pass to a lower level. In the down draft kiln a fluid lighter than air first moves downward in order to reach the base of the stack through which it is free to seek a higher level. To start a flow of water through the siphon it is necessary only to initiate the movement of a column of greater length downwards than the distance which the water is to move in the opposite direction. The greater the difference between these two distances the stronger is the flow; and the shorter the distance the water must move against the direction of gravity before it starts downwards the more easily is the flow started and maintained. The same principles may be applied to the action of gases in a down draft kiln. The stack is the portion of the siphon that propels the flow. The

greater its capacity the stronger will be the flow after it is once started; and the shorter the distance the gases are compelled to move downwards and laterally before reaching the stack the more readily is the draft started.

The practical application of the above comparison is plain. When the gases from the fires first begin to pour into a down draft kiln they tend to accumulate in the crown since they are lighter than the cold air already filling the kiln. Since they cannot escape upwards their expansion gains relief downwards by forcing some of the heavier cold air out at the bottom. The warm air slowly progresses downward until it fills the kiln, that which preceded it having passed out into the stack. Hot gas from the fires continually forces out through the stack the cooler air in the bottom of the kiln and a draft is gradually established. The shorter the distance which the air must travel downwards the sooner a draft is set up. It is of course necessary for the gases to travel the height of the kiln chamber. But the shorter the distance beyond this that they are required to go the better. The construction of deep flues is therefore to be avoided. The shallower the flues are and still furnish the required cross section area the more favorable will they be to freedom of draft. That is, the sooner the gases can be conveyed to the chimney after they have passed through the ware the more efficient does the draft system become. This rule involves not only the avoidance of deep flues but also the reduction of the distance through which the gases are to be carried laterally the greatest possible amount. The upward movement of the gases in the stack has alone to do with producing the draft. Movement laterally increases the friction, hence retards the draft. The closer the stack is to the kiln, therefore, the greater the extent to which this difficulty is avoided.

In connection with the construction of kiln flues a precaution which is very frequently neglected is the insulation of the flues

from the surrounding damp soil. The amount of heat used in the absorption of water from this source by the hot gases where the flues are unprotected has been estimated as equivalent to from 4 to 10 tons of coal during a single burn. The importance of such a loss as this is obvious. It can be largely obviated by carefully walling, arching and flooring the flues with brick and an impervious mortar or, entirely done away with by founding the whole kiln upon a concrete base from one foot to three feet thick.

In many instances, two or four kilns are so located that one large stack will serve them all. It is customary to partition the stack flue according to the number of kilns attached to it. The partitions ordinarily run only a fraction of the length of the stack. Where this is done, the single stack serves the purpose of so many separate stacks and is thus a saving from the standpoint of expense of construction. By partitioning the stack but part of the way to the top, the draft from one kiln will often aid in starting and maintaining that of another by the union of the separate flues into one above the partitions; for it seldom happens that all the kilns attached to a stack are at any given time running at the same stage of a burn.

Besides the proper construction of the various parts of the kiln so that its operation may be under accurate control, there must be provided means for this control. The flow of the draft is controlled by dampers. These are of two chief types, slide and valve dampers. The former are the more common. Slide dampers are operated either horizontally or vertically. When in horizontal position they are in the stack; when vertical, usually at the base of the stack in the main flue. Both are quite generally made of heavy sheet iron and operated by hand.

An improvement over sheet iron is the fire clay damper. A substantial construction for the latter is the use of fire clay tiles fitting into an iron frame. This makes a heavier damper but for

that very reason can be made to work more securely. In vertical position they are nicely operated by means of a counterpoise weight. A further advantage over sheet iron is freedom from the effects of the action of the hot gases which corrode and warp the iron in a short time. The long life of the clay damper therefore commends its use. The value of any damper depends on its ability to fully control the flue which it is designed to fit. In order to do this no leaks should be allowed and when closed the damper should cut off completely all draft. This is very commonly not the case, especially with many of the vertical dampers in use. The matter can only be perfectly adjusted by making the damper several inches wider than the flue and so that it will work in a notch in the flue walls. If it be a vertical one, a depression at the bottom partly filled with any finely ground refractory material, fine sand for instance, in which the damper may imbed itself is a great advantage. In general the horizontal damper is a more perfect contrivance as it tends by its own weight to prevent leakage of the flue gases around it. It is, however, when poorly constructed, fully as apt to allow cold air to pass in above it as is the vertical type, although at the same time the latter is more easily operated.

There are two types of valve dampers, the hinged and the bell. The former may be again separated into those that hinge from the side and those that are hinged at the center. The last of these is exemplified in the ordinary stove pipe damper. It is easily operated but cannot be made to work well with sooty or tarry gases. The side-hinged damper is convenient for controlling the draft in stacks the tops of which are accessible in case the damper gets out of order. It consists of a heavy iron plate or casting, or it may be built of fire clay, hinged at one side of the top of the stack. To it is attached a lever arm which is operated by a wire or chain from below. This is a very efficient damper and can be used on any of the lower kiln stacks. The

bell damper is centrally suspended from above from one end of a lever which may be weighted at the other so as to nearly counterbalance the weight of the damper. The damper is conveniently located at the base of the stack by provision in the construction so that the turn from the horizontal flue to the vertical stack is made by a step instead of a single right angle. By fitting the edges of the damper into slots filled with sand it can be made to absolutely cut off all draft when lowered into place. In this regard it is one of the most perfect dampers in use.

The number of stacks on round kilns varies from one to as many as there are fire holes. There appears no question but that the draft can be more easily regulated if concentrated in one stack which may be controlled by a single damper. The matter of the distribution of the draft in different parts of the kiln it is attempted to accomplish by the use of several stacks. The contention of those who advocate multiple stack kilns is that each stack can be made to control a definite portion of the kiln, which can therefore have its draft increased or diminished at will without reference to adjacent kiln space. It is evident that this cannot be fully realized unless the area which is to draw to a stack be partitioned from surrounding space, when it will of course operate as a single small kiln. As has been shown, the draft will always set towards and follow the line of greatest heat in the kiln. The kiln chamber may be considered as a vessel filled with a mobile fluid which responds to the action of gravity as do fluids with which we are more familiar. When a flow is set up through an outlet, there is not only a tendency for the gases to rush towards this outlet but the raising of the temperature by this act tends to confirm the movement in the given direction. To divert the draft it is necessary to close the damper when the gases will seek the next ready avenue of escape. A multiple stack kiln is, therefore, a complicated arrangement to control. It is clear that each and every stack will have a uniform draft only when

the heat is the same in every part of the kiln, which is difficult of attainment. The conditions of draft are often so badly over-balanced that the direction of movement is reversed in one stack, the air flowing down, through the kiln bottom, and up and out some other stack. Aside from the difficulty of good control the cost of construction is greater for numerous small chimneys than for one large one to do the same work.

The following points may be noted as important in the construction of round down draft kilns for burning the commoner grades of ware.

For burning brick, which are of necessity closely set and thus tend to restrict the draft, kiln diameters range from 20 feet to 30 and even more, the less the better the draft distribution. For wares such as drain tile and sewer pipe, diameters as high as 34 to 36 feet are found, although the lower should perhaps represent the maximum in most instances for economical burning.

The height of the kiln should be made to exceed very little the height of the ware stacked in it. Brick are set from twenty-five to thirty-five courses high. Six feet is perhaps an average distance from the floor to the spring of the arch; the arch having a rise of four to six feet depending on the diameter of the kiln.

The fire holes are best set from two to three feet below the level of the kiln floor. By so doing the radiation from the base of the bag walls becomes effective in heating ware near the kiln floor. This is the cool part of the kiln and where the fire holes are placed on a level with the floor, radiation is of little importance except from the upper half of the bag wall. It is usually better to sink the fire holes beneath the ground level than to raise the kiln floor above it; surrounding the kiln with a trench in which the firing is done. The trench is preferably paved with brick and good drainage should be provided for. This arrangement also helps to do away with the effects of the absorption of ground moisture.

The number of fire holes ranges from eight to twelve, according to the diameters given above. In general, the number of fire holes is about one-third of the diameter of the kiln in feet.

The type of fire place will depend on the ware to be burned and the character of the fuel used. This topic has been discussed on an earlier page.

The stack is placed close to the kiln and the flue connections should be as shallow as possible. There are some advantages in locating the stack in the center of the kiln. In this position a draft is more quickly started as the stack is heated as soon as the fires are lighted. Of course there are no horizontal flues, the radial flues opening directly into the stack. Because the stack is kept highly heated it is more effective and hence its dimensions will not need to be so great. The principal objections to the center stack are the kiln space which it occupies and the cost of construction. The space taken by it, which would otherwise be filled with ware, will be found to be a very small proportion of the whole and its position will seldom be an important obstacle in setting or drawing the ware. The stack must be made of fire brick and must have a solid foundation as it is subjected to the intensest heat of the kiln. These objections will, it is believed, be far outweighed by the advantages in the saving of fuel and the facility of operation with a kiln of this design.

The radial flues are to be recommended, in number generally one for each fire hole; in size and openings proportioned as described in an earlier paragraph. A connecting circular flue is sometimes of advantage.

The merits of the different styles of dampers are considered on a preceding page. For an outside stack, either the horizontal or vertical slide dampers can be made to give efficient service if properly constructed. The side-hinged valve damper is also an excellent means of control. With the center stack the latter is the only kind that is applicable. Since the draft is always more

vigorous in a center than in an outside stack, the damper that is used must afford a means of accurate and complete regulation. The hinge damper can be well adapted in this instance.

Rectangular Down Draft Kiln: The handling of the output of large brick plants requires that space be economized in every possible way. The distance which the brick are transferred from dryer to kiln and from kiln to car must be reduced to the minimum. The round down draft kiln holds from 30 to 60M. brick,

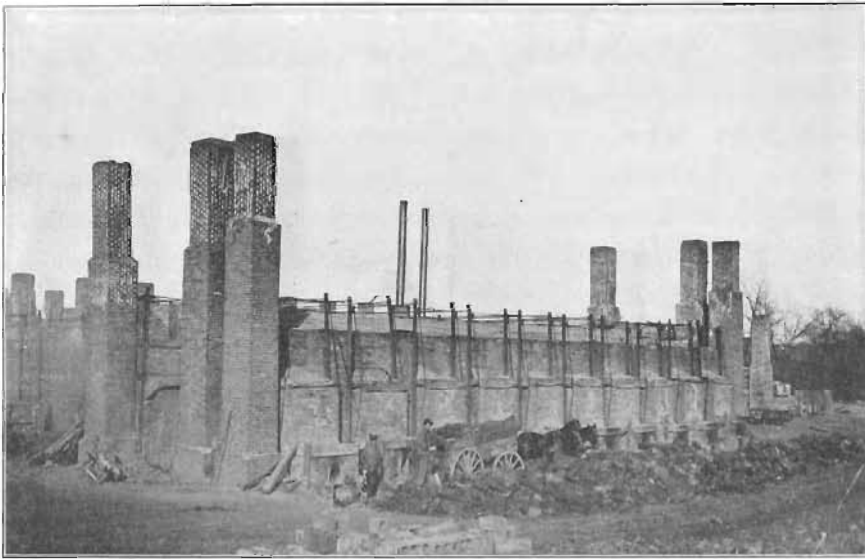

FIG. 29. Rectangular down draft kiln with stacks at the ends and showing ironing.

while an average rectangular kiln contains 150 to 200M. brick. To burn this number in round kilns would require several times the amount of space and would entail a much larger expenditure in the construction of the kilns, than to burn the same number in one kiln. The rectangular kiln is therefore an economizer of space and, while not ordinarily as susceptible a contrivance to delicate regulation in burning, is widely used and is eminently successful.

Rectangular kilns are built from 15 to 20 feet in width and as long as 100 feet. In this style of construction, it is evident that the conditions which have to be met in controlling the draft are somewhat different than in the round kiln. The general principles of draft movement discussed under the latter head will, however, apply equally well to the rectangular kiln. In particulars of construction, namely, kinds of fire place, use of false floor, height of kiln and relation between the levels of kiln floor and fire holes, the same rules will likewise hold good for the rectangular kiln.

The stack which controls the rectangular down draft kiln is located at one end or at the side. With the end stack it has been found impossible to obtain good draft regulation over all parts of the kiln unless the principles of flue arrangement described in the preceding section are put into effect. A single open flue through the center of the kiln is not sufficient. This flue must be covered and lateral flues opening into this center one constructed. The openings from the kiln chamber into both central and lateral flues should be proportioned in relative size according to their distances from the stack, and in total area according to the cross section of the stack. In general, these openings should in any portion of the kiln decrease in size from the sides towards the center; and be made gradually smaller towards the stack end of the kiln. Their total area should be less than the area of the stack so that an equal force of draft will be kept up in each one of the flues.

A common way of operating the rectangular kiln with an end stack is to divide the flue system into two parts. The main flue is divided by either a horizontal or a vertical partition to the base of the stack. Each part of this flue controls a definite portion of the kiln. Dampers in these divided flues may be operated so as to change or cut off entirely the draft from one section of the kiln, the whole strength of the stack in the last instance drawing

on one part of the kiln only. This arrangement amounts to the use of two stacks each controlling a definite proportion of kiln space and is not usually as satisfactory as the graduated flue system.

The side stack generally affords a better control of the kiln. The flue system is usually divided into three sections, separate flues leading to the stack from each. By dampering each flue the

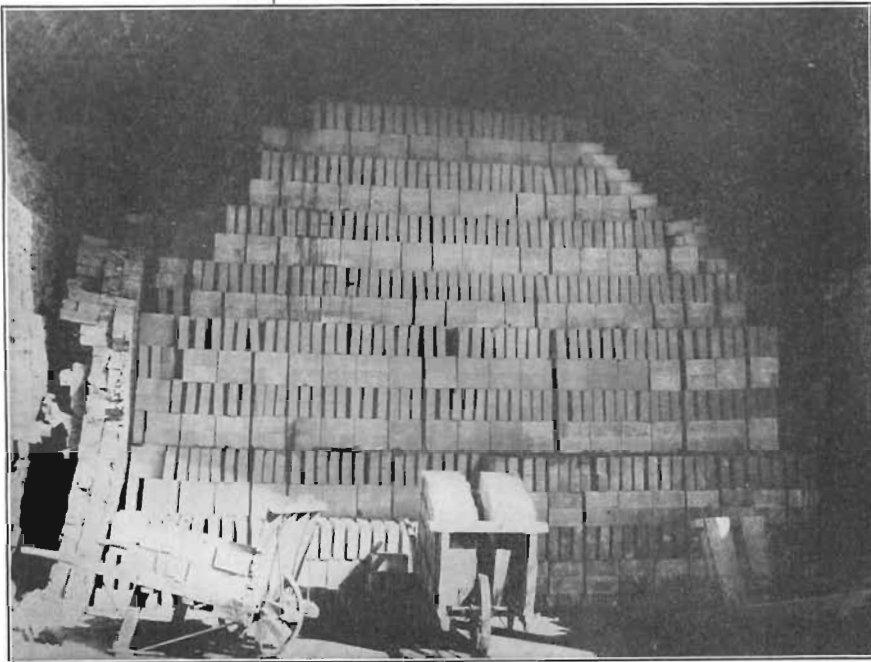

FIG. 30. Interior of rectangular down draft kiln showing method of facing dry pressed brick and a dissected flash wall.

flow of gases from any fraction of the kiln can be regulated. Such a flue arrangement combined with a proper floor construction can be made to give excellent results. Two stacks are also used with the rectangular kiln. They are usually situated at the sides and each controls a share of the kiln. By a central dividing partition in the main flue good work has been accomplished in the two stack kiln.

Multiple stack kilns are very widely used. The use of many stacks necessitates the division of the flue system into as many parts as there are separate stacks. Each stack thus controls a small system of its own which is separated from the others by solid partition walls and which may be operated with a greater or less degree of independence from all the others. It has been found, however, that unless there are combined in the construction the proper relation between the size of stack and flues, and the correct distribution of the inlets into the flues from the kiln chamber, as already described, that even burns are as difficult to realize as in any other class of kiln. These conditions are not fulfilled in many of the multiple stack kilns on the market. Kilns that are up to the requirements in these respects give excellent results and many burners testify to the evenness of burn it is possible to secure.

As stated under the consideration of round down draft kilns, the use of many stacks is seldom necessary. The cost of construction and maintenance is usually great. The amount of care in burning where there are so many stacks to look after, is much greater than with a single stack kiln and the damage coming from neglect is fully as large. While it is undisputed that as perfect work can be accomplished in multiple stack kilns as in other types, the idea of dividing among many, work that can be equally well done by a few or even a single stack is scarcely to be approved.

As in the case of the round kiln, a center stack construction appears to have advantages in its favor. The number of stacks needed would depend on the length of the kiln. A short kiln could be operated by a single stack, while two, three or more, would be needed in longer kilns. Each stack could control a space about equal to the ordinary round kiln; the radial flues and inlets being proportioned and arranged as in the round down draft kiln. In the rectangular kiln this arrangement would pre-

sent the same advantages of rapid and uniform heating and general economy as does the center stack in the round kiln. The sacrifice of kiln space is small in comparison with the saving from other sources.

The Muffle Down Draft Kiln: The necessity of a muffle kiln arises in the manufacture of classes of clay goods that cannot be burned in contact with the fire gases. Various lines of pottery, terra cotta, glazed brick, wall and floor tile and other wares that are apt to suffer from flashing, reduction or sulfur discolorations must be burned in muffle kilns. In the manufacture of wares such as wall tiles and certain grades of pottery in which the individual pieces are small, the effect of a muffle is secured by enclosing them in saggars. Saggars are simply small vessels of resistant fire clay in which the ware is tightly sealed or "luted" with moist clay. They are stacked in the kiln, just as pieces of ware would be, in such positions that the kiln atmosphere may circulate freely among them. Although not to be called a muffle kiln, this method accomplishes the work of a muffle with a less expenditure of heat.

The typical muffle kiln, instead of being made up of many small vessels or chambers that are drawn and set each time with the ware, consists of an enclosing chamber permanently built on the inside of the kiln proper. Inside of this chamber the ware to be burned is set and the whole then hermetically sealed, or as nearly hermetically as can be done with fire clay mortar. Between the ware and the hot gases is always an impervious wall through which the heat must penetrate before it can affect the clay inside. The heating is done very largely by radiation and conduction from the inside of the enclosing wall by the energy that has been conducted through the brick and clay of this wall. The principal means of transferring heat in ordinary kilns, namely, convection, is therefore eliminated. It is apparent that the waste of heat in this type of kiln is enormous. It can be

employed only where the value of the ware produced will warrant such wasteful processes of manufacture.

The essential parts of a down draft muffle kiln are, an outer shell similar in all respects to the down draft kiln; and an inner sealed chamber with space left between the two for circulation of the kiln atmosphere. An improved construction provides a center opening down which the gases pass into a well beneath the floor. From this well the gases are distributed through radial flues to as many exhaust stacks. The object to be attained is to keep the gases in contact the longest time with the largest possible amount of muffle surface for the space within. The width of the muffle chamber cannot economically be great as it is difficult to attain a uniform temperature in a large space where little or no movement of the air is possible.

THE CONTINUOUS KILN.

It has been shown under the general consideration of the application of heat to the burning of clays that the principal sources of loss of the heat units generated by the combustion of fuel are, the sensible heat of the waste gases and radiation. That portion of the heat that is actually effective in bringing about chemical changes in the clay is but a very small fraction of the available heat set free by the burning of the fuel. The remainder and larger part is thus dissipated into the atmosphere by the waste gases and radiated through the walls of the kiln. The latter loss can be reduced by adopting protective methods of constructing the kiln walls or by placing the kilns in the dryer building and utilizing this heat for drying and this can be done as well with one type of kiln as another.

In a periodic kiln the gases are necessarily taken out at the temperature of the ware and all the heat which they hold is absolutely wasted. Further, the heat which the ware gives off in cooling is likewise wantonly thrown into the atmosphere. The

central idea in the construction of the continuous kiln is the utilization of as much of the heat of the waste gases and of the cooling ware as is possible. This is accomplished by joining together a number of compartments so that the gases of combustion may be carried ahead of the burning chamber through green ware which will absorb much of the heat that is otherwise turned into the stack. The air for combustion to reach the zone of highest heat travels through chambers of cooling ware. In this way, not only is a large amount of heat saved from the escaping gases but the heat given off by the cooling ware is also made use of.

There are several makes of continuous kilns on the market in this country. The essential principles of the operation of all are similar. They are built circular, oval or rectangular in shape and contain a varying number of compartments. Whatever the general outline of the kiln as a whole, the number of chambers is sufficient to allow a space of a few compartments between the rear and the head of the fire for removing the burnt and setting the green ware. In some, the compartments are separated by brick walls, in others, no permanent partition walls are used. In the latter the size of the chambers and the division lines between them are made by paper or wood partitions which burn out when the temperature reaches a red heat. In some, the draft is prevailingly downward, in others, upward. In all, however, the method of burning consists of carrying the fire continuously round through a series of connected compartments, those in the rear of the hottest portion contributing their cooling heat to the entering air and the gases ahead of this zone of greatest heat giving up their energy to prepare the fresh ware for the advancing fire.

The limit to the distance which the gases may be carried ahead of the fire is the point where they approach saturation. It is apparent that in a continuous kiln there is going on at the same

time all three of the typical stages of the burning process, dehydration, oxidation and vitrification. The gases as they finally reach the stack may therefore have a complex composition. They may contain sulfur gases from the oxidation of sulfur in the coal and from the decomposition of sulfates in the clay. They will also contain water, both the hygroscopic and combined water of the clay. It is the presence of the water that determines largely the distance ahead to which the gases can be carried safely. Their heat is taken up to a great extent in the evaporation of moisture and they become rapidly cooler as their humidity increases. They cannot economically be allowed to reach the dew point as the dew is universally acid and its deposition would produce all the deleterious effects earlier ascribed to an acid dew; besides the probability of softening the ware in case of excessive deposition. The gases must be turned into the stack before their dew point is reached and while they still possess a temperature sufficiently above that of the atmosphere to create a draft. It is the effort of burners to approach this limit as closely as possible without overstepping it. Practice has shown that it is not ordinarily best to cool the gases too far but that the kiln can be more successfully operated by turning them into the chimney with sufficient energy still left to produce a good vigorous draft.

The necessity of operating the continuous kiln with stack temperatures so much lower than in the periodic kiln requires much higher and larger stacks to furnish ample draft. This is also required by the distance the gases have to travel, not only through oftentimes devious flues but through large amounts of ware which increases their friction greatly. The stack is very frequently located in the center of the kiln, sometimes at the end. It is not found necessary in most makes of this class of kiln to place the flues that lead to the stack below the level of the floor of the kiln. The great cooling effect of underground flues on gases passing through them is thus avoided and no heat is lost by the absorption of moisture from the soil.

In most continuous kilns the fuel, which is quite commonly slack coal, is fired right among the ware. It is charged through small openings in the top of the kiln. The setting is usually such that the coal is distributed from top to bottom by portions of it lodging on the projecting brick of the different courses. In burning face brick and other higher grade wares that would suffer from contact with the fuel, furnaces are used. The fuel is charged from above as before but within small compartments or bags from which the gases only pass among the heated ware. It is impossible in the continuous kiln to separate sharply the typical stages of burning. The chemical reactions characterizing the different parts of a burn are all going on at once. Dehydration, oxidation and vitrification are taking place in the same kiln atmosphere. It is well known that certain parts of a burn can be hurried while others must be carried on very slowly. It is therefore frequently necessary to hold back one portion of a continuous kiln until other parts are prepared for the advancing heat. To avoid such trouble auxiliary fire places are sometimes supplied in which fuel is burned to heat up the wet ware ahead of the main fire. Or, in some instances, warm air is brought from the cooling chambers and turned in ahead of the fire. This is only possible where the ware will stand more rapid cooling than the air passing through it to supply the fire will bring about.

The continuous kiln is not used to the same extent in the United States that it is in the European countries. Germany is the home of the continuous kiln and its use there has reached a stage of technical excellence which is unequalled in any other country. In Germany all classes of wares from the common brick to the highest grade porcelain are burned in the continuous kiln and with an economy which is unquestioned. In this country little else than common building brick have been successfully burned in this kiln. Many trials have been made to burn paving brick but few have been successful. The reasons for the failure of Americans to adapt the continuous kiln to the burning of the

various lines of clay wares appear to be several. In the discussion of this topic at the meeting of the American Ceramic Society in 1901 the following points were brought out bearing directly on American continuous kiln practice:*

1. "The American clay worker has not devoted himself to the study of the continuous kiln in its adaptation to American clays."

2. "The burning chambers are built too high and too wide. The best German kilns for the finer wares have chambers seven feet wide by six feet high."

3. "The fuel is almost invariably distributed among the ware which will not be satisfactory for anything except common brick."

4. "The kiln is worked too hard. The waste gases are drawn so far through green ware that condensation and consequent scumming are produced."

5. "The almost invariable use of underground flues. They produce a poor and variable draft."

6. "In most instances the water smoke is taken from the bottom of the kiln while it is best taken from the top."

7. "The continuous kiln should be erected by engineers properly trained for that work."

There appear to be no logical reasons why the same success cannot be had with the continuous kiln in this country that is attained in Germany. But it is only possible with the exercise of the same care and precision in construction and operation. Such an attainment will necessarily be slow but much progress has been made since its introduction relatively but a short time ago. From the standpoint of fuel economy the continuous kiln should be more widely used in the common brick industry where it has been made to give good satisfaction than it is at present. It is believed to be unquestionably the coming kiln in this industry and its use cannot but extend to all branches of clay-working as fuel grows scarcer, and more rigid economy must be practiced.

*Defects of the Continuous Kiln of Today and Prospective Improvements. Transactions American Ceramic Society, Vol. III, p. 205.

CHEMISTRY OF CLAYS

BY

J. B. WEEMS.

CHEMISTRY OF CLAYS

BY J. B. WEEMS.

CONTENTS.

| | Page |
|--------------------------------------|------|
| Chemistry of rock composition | 322 |
| Classes of clays | 325 |
| Rational analysis, object of | 326 |
| Ultimate analysis, object of | 326 |
| Rational analysis | 327 |
| Methods used | 330 |
| The chemical analysis of clays | 333 |
| Determinations made | 334 |
| Moisture | 334 |
| Loss on ignition | 334 |
| Silica | 334 |
| Aluminum and iron | 335 |
| Iron | 335 |
| Calcium | 336 |
| Magnesium | 336 |
| Alkalis | 336 |
| Titanic oxides | 338 |
| Sulfur | 339 |
| Ferrous oxide | 339 |
| The value of chemical analysis | 339 |
| Colors of clays | 340 |
| Incrustation on brick walls | 341 |
| Ultimate analyses | 344 |
| Rational analyses | 345 |

CHAPTER V.

Chemistry of Rock Composition.

Clay is a substance which we know as a deposit which is extensively distributed over the surface of the earth. It is found almost everywhere but differs greatly in its purity. This deposit has been produced by the decomposition of various rocks. As these decomposed products have been acted upon by water, the various original materials have been separated, leaving deposits of various kinds. Some of these we know, as sand, clay and various mixtures. Clay in its pure condition is comparatively rarely found, the larger portion of the deposit being composed of impure clay. Pure clay is a silicate of aluminum and when found in large quantities it is called kaolin. The various changes which take place upon the minerals present in the earth's crust, in order that clay may be produced is according to the results of Forchhammer shown in the formula

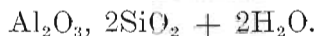

The changes which take place in the original rock to produce the clay substance may be shown by the following equation, as the result of the action of water and carbon dioxide upon feldspar.

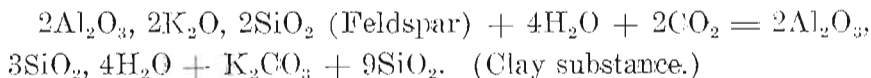

As an illustration of the various changes which may take place during the decomposition of the original clay substance both in the mechanical as well as chemical changes, the investigation of Reichart⁽¹⁾ is of interest: The results under column (a) represent the original material. The second column (b) gives the results

(1) *Hanlwörterbuch der Chemie* Ladenburg 12, p. 17.

of the product produced from the weathering processes and the third column (c) the resulting kaolin.

| | (a) | | (b) | | (c) |
|----------------------|-------|---------|-------|---------|-------|
| Coarse sand..... | 33.95 | } 78.05 | 22.56 | } 72.11 | 2.48 |
| Fine sand..... | 36.20 | | 37.40 | | 28.52 |
| Finest sand..... | 7.90 | | 12.15 | | 18.42 |
| Clay..... | 9.27 | } 21.95 | 12.26 | } 27.89 | 20.51 |
| Fine earth..... | 7.46 | | 8.55 | | 17.69 |
| Silt..... | 5.22 | | 7.08 | | 12.38 |
| Silica..... | 77.48 | | 75.73 | | 76.48 |
| Alumina..... | 17.10 | | 21.92 | | 21.58 |
| Iron oxide..... | 2.83 | | 0.98 | | 0.97 |
| Magnesium oxide..... | 0.84 | | 0.18 | | 0.17 |
| Lime..... | 0.38 | | 0.27 | | 0.25 |
| Magnesia..... | 0.10 | | 0.10 | | 0.07 |
| Potash..... | 1.03 | | 0.55 | | 0.16 |
| Soda..... | 0.13 | | 0.08 | | 0.01 |
| Phosphoric acid..... | Trace | | | | |

The resulting product from this decomposition is naturally a complicated mixture and it is necessary to study it not only from a chemical point of view but also its physical conditions. Such physical properties, as plasticity, naturally belong to the physical consideration of the subject.

It is of interest to note that as the result of the chemical changes taking place in the production of kaolin from the original rock that the amount of sand decreases while the clay substance increases. In the chemical results the amount of silica and alumina undergo only a slight change while ferric oxide, manganese oxide, calcium oxide (lime), magnesium oxide (magnesia), and the alkalis decrease as the results of the changes taking place in the products.

Pure clay substance is insoluble in dilute hydrochloric acid or nitric acid. Concentrated sulfuric acid decomposes it at 250° to 300° C. with the separation of sand and silica. Hydrofluoric acid in the presence of sulfuric acid decomposes the sand which may be present producing silicon fluoride which is volatile.

The fact that the clay substance with many of its impurities is acted upon by sulfuric acid enables the separation of the

clay substance from the sand or quartz. The action upon impure quartz of a dilute solution of sodium hydrate or sodium carbonate, furnishes means for separating the quartz from the amorphous silica. The action of sulfuric acid and the alkali has given rise to a method of analysis, which is known as rational analysis. Work of this nature has been carried on extensively by Aron and Seger. In some cases rational analysis is all that is necessary to enable one to determine, within certain limits, the relative proportions of quartz, clay and feldspar which may be present in the clay. For the determination of other substances, however, a complete chemical analysis is necessary.

The typical clay such as kaolin has the formula 2SiO_2 , Al_2O_3 , $2\text{H}_2\text{O}$. Its percentage of composition would be accordingly SiO_2 , 47.1; Al_2O_3 , 39.2; H_2O , 13.7. The impure clays contain feldspar such as orthoclase, K_2O , Al_2O_3 , 6SiO_2 , or albite, Na_2O , Al_2O_3 , 6SiO_2 and there will be also present mica having the formula K_2O , $3\text{Al}_2\text{O}_3$, 4SiO_2 and quartz. As a natural result of the weathering processes the alkalis disappear and aluminum and silica may be washed away after it is hydrated. Some of the typical clays may be shown by the following analyses: ⁽²⁾

| | PURE KAOLIN. (Zettlitz). Per cent. | KAOLIN WITH QUARTZ. Per cent. | KAOLIN WITH FELDSPAR. Per cent. |
|-----------------------------|--|-------------------------------------|---------------------------------------|
| Kaolin clay substance | 96.6 | 63.8 | 55.9 |
| Feldspar..... | 1.1 | 0.7 | 38.2 |
| Quartz..... | 2.3 | 35.5 | 5.9 |

Kaolin clay substance containing:

| | PURE KAOLIN. (Zettlitz). Per cent. | KAOLIN WITH QUARTZ. Per cent. | KAOLIN WITH FELDSPAR. Per cent. |
|-------------------|--|-------------------------------------|---------------------------------------|
| Silica | 45.6 | 45.3 | 47.1 |
| Alumina | 38.1 | 37.1 | 36.0 |
| Ferric oxide..... | 0.9 | 1.3 | 0.6 |
| Magnesia | 0.7 | 0.8 | 3.3 |
| Alkalis..... | 1.8 | 2.0 | |
| Water..... | 13.3 | 12.1 | 12.9 |

(2) Ref. Chemistry for Engineers and Manufacturers, Vol. II, p. 143.

The clays of all classes are prepared for use in manufacturing and depend upon two physical properties: (1) The ease with which they may be molded and shaped when wet, and (2) their change of state to a hard, unalterable product when subjected to heat. The chemical composition has little to do with the first physical property. The second physical property of course is affected more or less by the chemical composition of the clay and as there is dehydration and agglomeration it is accompanied by shrinkage. The effect of impurities present in pure kaolin is to lower the fusing point.

CLASSES OF CLAYS.

The clays are generally divided into three classes:

(1) Porcelain clay, which is approximately pure kaolin. This burns to white or light-cream color.

(2) Plastic clay, which contains more impurities than the porcelain clay. It burns to a yellow-red color and is used for ordinary earthenware.

(3) Fire Clays.—These clays approach very close to the porcelain clays in composition, however they contain a larger quantity of iron, also more silica as quartz. Some of the highest fire clays are very rich in quartz. The typical fire clay and brick clay as found in England, contains the following substances:

| BRICK CLAY. | PER CENT. | FIRE CLAY. | PER CENT. |
|---------------------------|-----------|-----------------------|-----------|
| Quartz | 16.42 | Quartz | 84.59 |
| Feldspar | 3.27 | Combined silica | 5.11 |
| Calcium carbonate | 4.45 | Alumina | 5.40 |
| Calcium sulfate | .95 | Ferric oxide | 0.21 |
| True clay substance | 74.91 | Lime | 0.20 |
| | | Magnesia | 0.09 |
| | | Potash | 0.61 |
| | | Water | 3.74 |

Clay substance consisting of:

| BRICK CLAY. | PER CENT. |
|--------------------|-----------|
| Silica | 46.96 |
| Alumina | 36.42 |
| Ferric oxide | 2.80 |
| Magnesia | 0.87 |
| Alkalis. | 0.91 |
| Water | 12.04 |

OBJECT OF RATIONAL ANALYSIS.

The rational analysis of clay has for its object the separation of the clay into clay substance, quartz and feldspar. The methods used depend upon the action of sulfuric acid upon the clay. The remaining residue contains amorphous silica and quartz. The amorphous silica is then separated from it by the action of sodium carbonate or sodium hydroxide. As to the value of the rational analysis of clay, there seems to be a difference of opinion upon the subject. For example, Ries considers that it is necessary and customary for the manufacturers of porcelain or earthenware or fire brick or any product made from high grade clay to use the rational analysis as a guide for their mixtures in order to obtain a constant product. It is claimed that the advantage of this method is that it separates the clay into middle components and enables one to obtain an idea of the physical character of the material. This is claimed to be, frequently, a matter of far greater importance than is the chemical composition of the clay. It is claimed that the ordinary ultimate analysis only considers the clay as a mixture of oxides and that these substances may be present as silicates, carbonates, hydrates, sulfates, etc. Silica, it is claimed, will decrease the shrinkage and up to certain limits of temperature increase the refractoriness. If, however, it is present in combination as feldspar, it acts as a flux and somewhat increases the plasticity.

In contrast with the value of the rational and ultimate analyses of clay it may be said that each has its value and cannot replace the other.

The value of the ultimate and rational analyses and what may be indicated by them, is stated by Ries, as follows:

OBJECT OF ULTIMATE ANALYSIS.

“The ultimate analysis may be used to supply information on the following points:

(1) The purity of the clay, showing the proportions of silica, alumina, combined water, and fluxing impurities.

(2) From the ultimate analysis we can form an estimate of the refractoriness of the clay, for, other things being equal, the greater the total sum of fluxing impurities the more fusible the clay.

(3) The color to which a clay will burn may also be judged approximately, for the greater the amount of iron present the deeper red will the clay burn, provided the iron is evenly and finely distributed, and an excess of lime is not contained in the clay. If the proportion of iron to lime is as 1 to 3, then a buff product results, provided the clay is heated to incipient fusion or vitrification, the above condition will be affected by a reducing atmosphere in burning, or the presence of sulfur in the fire gases.

(4) Clays with a large amount of combined water sometimes exhibit a tendency to crack in burning. This combined water would be shown in the chemical analysis.

(5) A large excess of silica would indicate a sandy clay."

These are practically all the points which the ultimate analysis explains, and they are mostly of a chemical nature.

METHODS USED IN RATIONAL ANALYSES.

As regards the rational analysis it may be carried out in a simple way or in an elaborate one.

Most kaolins and other high grade clays consist only of kaolinite, quartz and feldspar, the kaolinite forming the finest particles of the mass while the balance is quartz, feldspar and perhaps some mica. The finest particles are known as the clay substance, which may be looked upon as having the properties of kaolinite, for the latter is present in it in such a large excess. Now as each of these three components of the kaolin—clay substance, quartz and feldspar—have characteristic properties, the kaolin will vary in its behavior as one or the other of these constituents predominates or tends to increase.

As to the characters of these three: Quartz is nearly infusible, non-plastic, has very little shrinkage, and is of low tensile strength; feldspar is easily fusible, and of low plasticity by itself; kaolinite is plastic and quite refractory, but shrinks considerably in burning.

Mica may practically be considered as kaolinite, for the reason that there is usually so little of it, and also because the experiments of G. Vogt have indicated that it acts very similarly to kaolin, being, when fine, fairly plastic and unaffected by a temperature of 1,300° C. In chemical composition it is of course different from kaolinite, but from a physical point of view it is similar.

The investigations of Vogt⁽³⁾ have called attention to the fact that in the cases where the analyses of clays were made with determinations of kaolin, feldspar, and quartz the results are not satisfactory. In the attempt, from the results obtained in the analyses, to imitate the porcelain of China and Japan the conclusion was reached that 50 parts of kaolin, 30 of feldspar and 20 of quartz would meet the requirements and upon this data the manufacturing of porcelain in Europe was founded. Vogt calls attention to the fact that in the rational analyses as carried out under these conditions, no attention was paid to the mica which may have been present. The experiment proved that a clay composed of kaolin 20, mica 25 and quartz 40 yielded merely stoneware of fine quality. In order to obtain the beautiful and transparent porcelain a quantity of feldspar was found necessary. The following mixture was prepared with this object in view: kaolin 25, mica 25, orthoclase 25 and quartz 25. In some cases, however, in the ordinary manufacture of cheaper ware and cheap clay products it is not deemed necessary to make the analysis complete as carried out by Vogt.

(3) Bull. de La. Soc. Chim. d. Paris, Abst. Chem. News 62 (1890) p. 315.

From a scientific point of view, it is generally conceded that the results of the rational analysis is as stated by Doctor Bischof, "Ein Kuntschlich Theoretisches Bild."

This is due to the assumption that, in the calculation from the analysis, the mineral sand is regarded as feldspar. The separation of the mineral, quartz sand and clay substance cannot be regarded in any way as an accurate analysis.

Langenbeck⁽⁴⁾ in speaking of the analytical results obtained from the treatment of the feldspar in the same manner as the clays during the analytical process, states that pure feldspar left a residue of 81.44 per cent and in the other 83.95 per cent. Attempts have been made to remedy the action of the concentrated sulfuric acid upon feldspar, by treating the clay with dilute sulfuric acid under pressure. Yet it was found that the clay was only partially decomposed while the feldspar was acted upon to the extent of leaving a residue of 82.67 per cent which is practically the same as when treated with concentrated acid. Langenbeck states that under the existing methods used in the rational analysis it is impossible to dissolve the clay substance out of the clay without a loss of feldspar that may reach 20 per cent of the material present. The action of sulfuric acid has an effect upon the quartz, although not so much as upon the feldspar. In the examples given it was found that the acid may dissolve from the quartz 3.88 per cent as the result of its action. However, in spite of the imperfections of the methods used in rational analysis there is no doubt but that from a practical point of view the results are of value for it has enabled the manufacturer to mix the natural clays with other substances in which the clay lacks and this enables him to deal with many of the problems connected with his work. Where the ultimate method would be, under ordinary circumstances, an unintelligible analysis the rational analysis is of service to him.

(4) Chemistry of Pottery, pp. 8-12.

In some cases the fact that the action of the sulfuric acid upon the clay will dissolve a quantity of feldspar and some of the quartz, has led some investigators to reject the rational analysis. As an example of this objection the following is of interest in connection with the rational analysis,⁽⁵⁾ "On account of the fact that the Wisconsin clays contain a large amount of feldspathic material the rational analysis would have little significance and the following method was adopted to calculate the feldspar and kaolin, from the ultimate analysis, using the following percentages of composition of feldspar:

K_2O , 16.9; Al_2O_3 , 18.4; $6SiO_2$, 64.7; Na_2O , 11.8; Al_2O_3 , 19.5; $6SiO_2$, 68.7; and kaolin: Al_2O_3 , 39.5; $2SiO_2$, 46.5; $2H_2O$, 14. Under these conditions potash and soda were regarded as part of feldspar. The alumina required for this amount of feldspar was deducted from the total alumina present and the remainder was the basis on which the kaolinite substance was calculated. The difference between the total amount of silica and that required by feldspar and kaolin gives the amount of quartz present."

In connection with the calculation of the rational analysis the following results showing the composition of various feldspars will be of interest.⁽⁶⁾

| | POTASSIUM FELDSPAR ORTHOCLASE. ($K_2Al_2Si_2O_{10}$) Per cent | SODIUM FELDSPAR ALBITE. ($Na_2Al_2Si_2O_{10}$) Per cent | CALCIUM FELDSPAR ANORTHITE. ($CaAl_2Si_2O_8$) Per cent |
|---------------------------------|---|---|--|
| Potassium oxide, K_2O | 16.89 | 11.82 | 20.10 |
| Aluminum oxide, Al_2O_3 | 18.43 | 19.56 | 36.82 |
| Silica, SiO_2 | 64.68 | 68.62 | 43.08 |

There are in use two methods for the determination of silica, feldspar, and quartz in clay. The following is one of the methods which is used in Germany:⁽⁷⁾

"About five grams of clay are weighed and placed in a 200 c. c. Erlenmeyer flask. 100-150 c. c. of water and two c. c. of sodium

(5) Clays and Clay Industries of Wisconsin, p. 267.

(6) König Untersuchung Land. Gewerb. Stoffe.

(7) Ladenburg-Handwoerterbuch der Chemie, 12, p. 15.

hydrate are added and the contents boiled, covering the flask with a small glass funnel. The contents of the flask are allowed to cool and 25 c. c. of sulfuric acid is added. Continue the boiling until the fumes of the acid begin to be driven off the flask.

As a result of the reactions which have taken place the calcium carbonate has been changed to calcium sulfate, the aluminum silicate has been converted into aluminum sulfate and silicic acid, while the quartz and feldspar remain. Water is added to the flask and most of the sulfuric acid and aluminum sulfate washed out of the residue by decantation.

In washing by decantation the water which is decanted should be placed upon a filter paper for the reason that should any of the residue be removed from the flask it can be returned by making a hole in the filter and washing back into the flask.

After washing by decantation the contents of the flask are treated with hydrochloric acid (100 c. c.) and boiled. Decant off the liquid and add sodium hydroxide (100 c. c.) boil and decant. Repeat the above process with hydrochloric acid and sodium hydrate. The residue is then transferred to a filter and washed with dilute hydrochloric acid (1 to 20). The filter with contents is transferred to a platinum crucible and weight determined.

The contents of the crucible are treated with a few drops of sulfuric acid and small quantities of hydrofluoric acid, evaporated to dryness in the water bath, ignited, weighed, and from the loss calculate and determine aluminum, iron, etc. From the aluminum found in the residue the feldspar is calculated, 1 part of alumina (aluminum oxide) = 5.41 of feldspar.

Another method which has been used in much of the work of this country is as follows:

The material (two grams) is treated with dilute sulfuric acid (20 c. c.) for six or eight hours on a sand bath, and the excess of acid is finally driven off. One cubic centimeter of concentrated hydrochloric acid and a small quantity of water is added. The

residue is separated by filtration and thoroughly washed with hot water. The residue is then treated with a small quantity (15 c. c.) of a boiling ten per cent solution of sodium hydroxide, 25 cubic centimeters of hot water are added and the solution filtered through same filter paper. The residue is washed six or eight times with hot water by decantation. The residue is then treated with dilute hydrochloric acid and washed, and transferred to the filter paper. The filtrate should be free from hydrochloric acid before the washing is finished. The residue on filter paper is burned and weighed, the result is the residue, insoluble in sulfuric acid and sodium hydrate. A part of this residue is used for determination of silica, aluminum oxide, and iron oxide and the other part for determining alkalis present in the insoluble residue.

The results furnish the means for calculating the rational analysis. The aluminum oxide present in the insoluble residue is multiplied by 3.51. This factor is regarded as the ratio between the silica and aluminum oxide in orthoclase feldspar. The product found represents the amount of silica present in feldspar. The sum of the amounts of silica, aluminum and ferric oxides, and alkalis represents the "feldspathic detritus." The difference between the silica combined and the total silica in residue gives the "quartz" or "free sand." The sum of the "quartz" and "feldspar" gives the basis for calculating the clay substance.

In the rational analysis it has been seen that there is a choice in the use of sodium hydroxide or sodium carbonate to dissolve the amorphous silica after the clay has been acted upon by sulfuric acid. The question sometimes presents itself as to the strength of the alkali to be used.

Lunge and Milberg⁽⁸⁾ in their investigations, concluded that the results of Michaelis, that a 10 per cent solution of NaOH does not

(8) *Zeits. Angew. Chem.*, 1897, pp. 395-425, *Abstr. Jr. Soc. Chem. Ind.* 16 (1897) p. 762.

act upon the quartz even during several hours boiling and that the soluble silica cannot even be dissolved by sodium carbonate, do not stand the test of investigation. In their experiments, Lunge and Milberg submitted a large number of different silicates with the results that caustic alkalis can not be safely employed to separate the quartz from the soluble silica, as quartz is dissolved during the process. Hot solutions of alkaline carbonates can only be used after finely powdered material has been washed away. It is stated that some quartz is dissolved even by a 5 per cent solution of sodium carbonate at the temperature of the water bath. It is stated, however, that the error will probably not exceed .1 per cent to .2 per cent, the soluble silica being returned high. Hardened filter papers should be used in the analysis. The modification of the process as suggested by Lunge and Milburg is in the analysis of the silicates after the sample has been reduced to the finest kind of powder, treated with hydrochloric acid and dried at 110 C. The amorphous silica can be readily determined by digestion for fifteen minutes in a 5 per cent solution of sodium carbonate and the error need not exceed .2 per cent. In the determination of aluminum and iron, Meinke states that there is a tendency for the iron and aluminum to contain a certain amount of silica, this amount may vary from .3 to 1 per cent.

The Chemical Analysis of Clays.

Besides the rational analysis, many times the complete ultimate analysis of clay is of value. In order that the chemical analysis may be of value it is necessary that the analytical work have the best possible care. Langenbeck calls attention to this subject in the following words: "While it is true that the chemical analysis alone, however accurate, is insufficient without accompanying physical tests to give one the perfect characteriza-

tion of clay, its value is sufficiently great to warrant the most careful work."

Clay, according to Blair, is a mixture of silica and the silicates of aluminum, calcium, magnesium, potassium and sodium. The silicates are hydrated and as a result they may contain from 6 to 12 per cent of water chemically combined. In addition to the substances named, clay may contain ferric oxide, titanio acid, ferric sulfate, organic matter and phosphoric acid. Occasionally, rare elements are found.

In the analysis of clay the following determinations are made:

(1) *Moisture*.—Two grams of clay are heated in a platinum crucible at 100° to 105° C., until a constant weight is reached. The loss in weight is regarded as moisture.

(2) *Loss on Ignition*.—This result includes combined water, organic matter and carbon dioxide in the form of carbonates.

The clay from the determination of moisture can be used for this determination. The crucible is heated with a blast lamp until it becomes constant in weight.

(3) *Silica*.—Clay being practically unacted upon by hydrochloric acid, it is impossible to use the substance for preparing a solution and it is necessary to fuse the product in order to decompose the silicate. One gram of finely divided clay is mixed with ten grams of sodium carbonate and a little potassium nitrate in a platinum crucible. The mass is brought to fusion in a platinum crucible, using the blast lamp if necessary. After the mass is fused it is run well up on the sides of the crucible and allowed to cool. Add hot water and when the mass is thoroughly disintegrated, treat the undissolved portion with hydrochloric acid. Transfer the mass to a casserole and evaporate to dryness on water bath, heat in air bath at 110° until all the hydrochloric acid is driven off. Dilute hydrochloric acid (60 c. c.) is added to the contents of the casserole and the contents brought to boiling. Transfer the material to an ashless filter, wash it

thoroughly with hot water, dry and transfer to a platinum crucible and weigh. The filtrate is used for the determination of the other constituents. The silica present in the crucible is treated with sufficient sulfuric acid to moisten it. Hydrofluoric acid is added cautiously in very small quantities successively until the silica has disappeared. Evaporate the contents of the crucible to dryness in a sand bath or on an asbestos board, ignite and weigh. The difference in weight represents the silica.

(4) *Determination of Aluminum and Iron.*—The filtrate from the silica is treated with an excess of ammonia and boiled until the ammonia in excess is driven from the solution. Filter and wash several times with hot water. The precipitate is dissolved with a mixture of 15 c. c. hydrochloric acid and 15 c. c. of water, and allow the solution to run into a small clean beaker. If any part of the precipitate remains in the larger beaker, in which the first precipitate was made, a part of the contents of the small beaker may be used for dissolving it. Wash the beaker and filter paper in order that the small beaker may contain all of the precipitate. Re-precipitate with ammonia as usual. Filter, transfer the precipitate to the filter paper and wash thoroughly with hot water. Dry, ignite the precipitate and weigh. It may be necessary to treat the residue before igniting with a few drops of nitric acid to convert any iron or ferrous oxide which may be present into ferric nitrate. Evaporate off the acid and weigh the contents of the crucible. The results will be the quantity of aluminum oxide, Al_2O_3 , and ferric oxide, Fe_2O_3 .

(5) *Determination of Iron.*—Fuse the precipitate of aluminum and iron oxide with Na_2CO_3 , and treat the fused mass with water. Wash into a small beaker and decant off the clear liquid into the flask used for the determination of iron volumetrically and determine in the usual manner.

If desired, citric acid can be added to the solution with an excess of ammonia and the iron precipitated as sulfide. Filter,

wash the precipitate, dry and determine iron in the usual manner. The amount of iron, subtracted from the total amount of aluminum and ferric oxides, gives the amount of aluminum.

(6) *Determination of Calcium.*—The filtrate from the determination of ferric and aluminum hydroxides is concentrated to about 200 c. c. and ammonium oxalate added to precipitate the calcium. The precipitation of the calcium should be from a hot solution. Allow the precipitate to settle twelve hours. Ammonium oxalate should be in excess in order to prevent the precipitation of any magnesium. Some prefer to add one grain of ammonium oxalate to insure an excess. The precipitate is filtered and washed with hot water, ignited and weighed in the usual manner. The resulting product is calcium oxide.

(7) *Determination of Magnesia.*—The filtrate from the determination of calcium precipitation is concentrated until about 150 c. c. Allow the solution to cool and precipitate the magnesia from an alkaline solution by means of hydrogen disodium phosphate. Fifteen minutes after the precipitation add 15 c. c. of concentrated ammonium hydroxide, sp. gr. .90. The magnesia ammonium phosphate is allowed to stand for at least two hours and is filtered through an ashless filter. Wash with water containing 5 per cent of ammonium hydroxide. Place the filter, after drying, in a crucible, ignite, and weigh in the usual manner. The resulting residue is magnesium pyrophosphate, and from the result the amount of magnesia is calculated.

(8) *Determination of Alkalis.*—The determination of alkalis in clay is made by treating two grams of finely ground material in a platinum dish with four c. c. of concentrated sulfuric acid and 50 c. c. of pure hydrofluoric acid. The contents of the dish should be stirred with a platinum wire in order that the acid may come in contact with the clay. The contents of the platinum dish is heated carefully until the clay is entirely decomposed and the gritty portion has disappeared. Evaporate to dryness, and

heat until the sulfuric acid is driven off and the fumes cease to be evolved. The use of hydrofluoric acid should be carried on under a hood where there is a strong draught. It is dangerous to handle the hydrofluoric acid in a place that is not well ventilated with a strong draught. After evaporating to dryness in the hood, 50 c. c. of water and a little hydrochloric acid is added. The mass should dissolve; if it does not, heat until it does. If there is any insoluble matter, it shows that the clay has not been thoroughly acted upon by the hydrofluoric acid. The soluble material can be transferred to another dish, and the operation repeated by means of hydrofluoric acid upon the insoluble residue in the dish. After thoroughly decomposing, the solution is diluted to about 350 c. c. by adding water. After placing in a beaker, heat to boiling, add an excess of ammonia and allow the precipitate to settle, and filter. The precipitate is transferred to the beaker in which the precipitation was made, by piercing the filter and washing with hot water. Add about 200 c. c. of water and a little ammonia. Transfer to the filter and wash thoroughly. The two filtrates are united, evaporated to dryness in a platinum dish. Heat in order to volatilize the ammonium salts. Add a few drops of hydrochloric acid and evaporate to dryness and heat to low red heat. The resulting residue represents the alkalis in the form of chlorides.

If it is desired to separate and determine the amount of potassium present, this can be done by precipitating the potassium chloride and determining it as K_2PtCl_6 in the usual manner.

(9) *Smith's Method of Determination of Alkalis.*—Instead of determining the alkalis by means of hydrofluoric acid and sulfuric acid, the method given by Smith may be used. The method is as follows: one gram of finely ground clay is mixed thoroughly with an equal weight of granular chloride of ammonia in a porcelain or agate mortar. To this mixture eight grams of calcium carbonate are added. Grind the mass together thoroughly so that

it is intimately mixed. Transfer the material to a large platinum crucible covered with a close fitting cover and heat slowly in order to decompose the ammonium chloride. This is accomplished in a few minutes, then heat, gradually increasing until the crucible is red. The bottom of the crucible is kept at a bright red heat for about one hour. The crucible is allowed to cool and, if the mass can be detached easily, transfer it to a platinum dish and add 80 to 100 c. c. of water. Remove any residue which may remain in the crucible, cover with water and wash the contents of the crucible into a dish. The contents of the dish are heated to boiling and the mass is allowed to slake completely. After slaking, filter and wash the residue thoroughly with hot water.

In case the contents of the crucible, after fusion, can not be removed easily, the crucible is placed on its side in a dish, the cover washed off and 100 c. c. of water added. The contents of the dish are heated until the mass can be removed. Remove the crucible from the dish, wash thoroughly and filter the liquid from the dish and wash the residue. The filtrate is treated with about one and one-half grams of pure carbonate of ammonia and filtered. Evaporate the solution in a platinum dish until it is reduced to 50 c. c., add a small quantity of ammonium carbonate and ten or fifteen drops of ammonia. Filter off the precipitate, if any is produced, and evaporate. Heat carefully to drive off the ammonium salts. The alkalis are present in the form of potassium and sodium chlorides. The addition of a few drops of hydrochloric acid will prevent any loss of material during the process of heating in driving off the ammonium salts.

(10) *Determination of Titanic Oxide.*—The determination of titanic oxide is made by placing one-half gram of clay in a platinum crucible and thoroughly mixing with five grams of potassium bisulfate and one gram of sodium fluoride. The mass is fused, allowed to cool and then dissolved with a five per cent solution of sulfuric acid. An aliquot part of the resulting solution is

placed in a Nessler tube, hydroxide is added and the tint developed is compared with the standards made from solution of titanium sulfate.

(11) *Determination of Sulfur*.—The total sulfur present in clay is determined by fusing one-half gram with a mixture of sodium carbonate, five parts, and potassium nitrate, one part, in a platinum crucible. The fused product is dissolved by dilute hydrochloric acid. The sulfur separated in the usual manner by evaporation and heating in order to render the silica insoluble, and filtered. Hydrochloric acid is added in order to have an excess of the acid present. The sulfate present in solution is precipitated by means of barium chloride in excess. Both solutions should be hot. The barium sulfate is filtered, washed with hot water, dried, placed in a crucible and weighed, and the sulfur or trioxide calculated from the results.

(12) *Determination of Ferrous Oxide*.—Ferrous oxide can be determined by fusing one-half gram of clay with five grams of sodium carbonate. The clay in a crucible should be well covered with carbonate. The contents are heated, the crucible being covered. The fused mass is dissolved and mixed with hydrochloric acid and sulfuric acid in an atmosphere of carbon dioxide. Ferrous iron is determined by titration with standard potassium permanganate.

THE VALUE OF CHEMICAL ANALYSIS.

As previously stated, the value of the rational analysis lies in the fact that from a theoretical point of view it is designed to separate quartz, feldspar and clay substance in the clay. The chemical analysis, on the other hand, can be used to draw certain inferences which are also valuable.

According to Ries, the following facts can be drawn from the chemical analysis:

(1) In the chemical analysis of clay the depth of the red color depends upon the amount of ferric oxide. A large percentage of ferric oxide produces a deep red color, while a small amount gives the yellow colors.

(2) The analysis will determine whether lime present is sufficient to counteract the action of the ferric oxide.

(3) That an approximate idea of the fusibility of clay can be obtained from the total amount of fluxes present and also the nature of the fluxes, whether they are weak or strong.

(4) The clay containing a large percentage of silica indicates generally a sandy clay.

(5) Clays having a high percentage of alumina and combined water, as a rule, shrink considerably on burning.

It is also stated that besides the tendency to shrink as indicated by chemical analysis, other physical tendencies are largely dependent on the mineralogical composition.

THE COLORS OF CLAYS.

The iron oxide present in the clay will produce certain definite colors dependent on the amount of oxide present. According to Professor Winchell, the cream colored bricks in Minnesota are produced as a result of the iron which is present in the clay entering into combination with silica and alumina instead of remaining as an oxide. The various manifested tints which are exhibited in many clays are practically due to a mixture of carbonaceous matter and iron. It is well known that the oxides of iron will cause white aluminum silicate to change its color to a grayish-blue and even to a black color. In clays where the color is produced by carbonaceous or other organic matter it will entirely disappear in burning if an excess of air is possible. Blue clay, it is said, can not be decolorised by digestion in hydrochloric acid, and on heating it becomes more intense, owing to the separation of particles of carbon, and these finally disappear.

Colored waters, if mixed with clays, will color them slowly, while kaolin, if mixed with brown, peaty water and allowed to stand for eight or ten days, will become brownish-blue. This color becomes more distinct when it is dried. If treated the second time this residue becomes brown, and by constantly repeating the process a dark-blue clay with a brown tint has been obtained similar in color to many of the natural clays.

INCRUSTATION ON BRICK WALLS.

Under certain conditions brick walls become colored by the production of white incrustations which appear after the wall is built. This incrustation sometimes is produced even before the building is complete, and unsightly white patches disfigure the building. In some cases it has been noticed that bricks which have never come in contact with the mortar have had this incrustation upon them. On examination the incrustation was found to be sulfate of magnesium. As a rule, this sulfate is discolored by other compounds, such as oxide of iron. Under other conditions the incrustation has proved to be a mixture of calcium and magnesium sulfates, with traces of iron and aluminium oxides. Carbonates were not found to be present. The material which produces this incrustation is therefore evidently of the nature of soluble sulfate, and the question arises whether these substances are present in the original clay or not. Investigations made upon these incrustations prove that calcium or magnesium sulfates are not present, usually, in the original clays. There is a small proportion of lime and magnesia, and no doubt the burning of brick accounts for the conversion of the magnesia and lime, which is present in the clay, to the corresponding sulfates, by the sulfur oxide produced from the sulfur in the coal as sulfide of iron or iron pyrites. When the coal is burned, sulfur dioxide in the presence of air and moisture produces sulfuric acid, which combines with magnesia and lime. The acid probably decomposes

the calcium and magnesium silicates, producing sulfate of calcium and magnesium, while silica is set free. The sulfate of magnesium possesses the peculiar property of efflorescence in the presence of dry air. A small amount readily becomes conspicuous. It has been suggested that the only way to prevent the incrustation is naturally to prevent the formation of magnesium sulfate in brick. In other words, to burn the brick intended for exposure to the atmosphere with material which will not produce sulfuric acid in a large enough quantity to produce sulfate of magnesia during the process.

Another source of trouble may be said to lie in the fact that mortar is produced from magnesium limestone and is really a mixture of lime and magnesia in various proportions. Of course, in the presence of fumes of sulfur dioxide, magnesium sulfate is readily produced from the magnesia, and the salt makes itself manifest in the efflorescence. Of course it can be readily seen that houses built with mortar from lime containing a large amount of magnesia can be acted upon by smoke containing a quantity of sulfur oxide, readily producing magnesium sulfate.

If lime should be the source of the trouble, then it is necessary to use lime in building which is free from magnesia, for that portion of the brick work which is exposed. In some houses these white incrustations of magnesium and calcium sulfates are rendered still more unsightly by black streaks. This is caused from repeated washing of the black dust from the window cases and frames. Of course the problem here is for the builder to use for that part of the building which is exposed, bricks containing a minimum amount of sulfuric acid produced from coal containing a small amount of sulfur, and mortar which is free from magnesia. It is a problem for prevention instead of endeavoring to discover a remedy for the mischief.

According to the investigation of Gunther, however, the iron pyrites present in the clay is one of the causes of efflorescence and this is not the result of the material used in burning the brick. Gunther stated that almost all clays contain sulfide of iron or pyrites, and this in the presence of magnesia gives rise to the efflorescence, after the decomposition of alkalis in the presence of water.

He regards the sulfur present as the cause of the trouble. The remedy which, as suggested by Gunther, is to mix barium carbonate or chloride in clay; this substance would combine with sulfuric acid, producing barium sulfate. The sandstone of many new buildings suffer with this trouble of efflorescence. From experience it is found that it has been impossible to prevent the formation of soluble sulfate entirely, but it has been suggested that an excess of baryta would be present at all times, combining with any sulfuric acid to produce insoluble barium sulfate. The addition of baryta to the mortar has been suggested as a remedy to check the efflorescence. Of course this check would be limited if the mortar is exposed to the action of the fumes of sulfur from the chimneys where coal is used containing a large amount of sulfur.

As a matter of interest I would note the investigation of Director Parize of the Agricultural Station at Morlaix, France, whose work has led to the conclusion that the crumbling of brick is due largely to the action of microbes. The result of the action of the microbes is a red dust which on examination with the microscope was found to contain a number of microscopic organisms. This opens a wide field for the investigation of many problems connected with the decay of walls of brick buildings.

ANALYSES OF CLAYS.

| Number. | SAMPLE FROM. | Moisture. | Potassium oxide. | Sodium oxide. | Calcium oxide. | Magnesium oxide. | Ferric oxide. | Alumina. | Sulfur tri- oxide. | Carbon dioxide. | Loss in ignition. | Total. |
|---------|---|-----------|---------------------|------------------|-------------------|---------------------|------------------|----------|-----------------------|-----------------|-------------------|--------|
| 1 | Flint Brick Co., Des Moines, bottom..... | .20 | .95 | 1.50 | 2.57 | 1.57 | 4.80 | 15.75 | .97 | 1.71 | 3.22 | 100.80 |
| 2 | Flint Brick Co., Des Moines, middle..... | .76 | .63 | .89 | 1.80 | 1.44 | 5.28 | 21.12 | .95 | 2.07 | 9.75 | 99.91 |
| 3 | Flint Brick Co., Des Moines, top..... | 1.09 | .24 | .58 | 3.17 | 2.72 | 2.88 | 15.47 | .95 | 1.25 | 4.37 | 99.87 |
| 4 | Iowa Brick Co., Des Moines, No. 7, bottom..... | .42 | .52 | 1.15 | 3.53 | 2.16 | 4.79 | 21.01 | .95 | | 4.51 | 100.86 |
| 5 | Iowa Brick Co., Des Moines, No. 8, top..... | .25 | .39 | 1.35 | 3.17 | 1.42 | 4.51 | 16.68 | 1.00 | 2.99 | 1.44 | 100.40 |
| 6 | Iowa Brick Co., Des Moines, No. 5, top..... | .84 | .21 | 1.90 | 6.59 | 1.87 | 1.92 | 20.43 | .45 | | 6.82 | 100.50 |
| 7 | Iowa Brick Co., Des Moines, No. 4, top..... | .83 | .80 | 1.48 | 3.17 | 1.34 | 3.63 | 21.97 | 1.15 | 1.58 | 3.59 | 100.63 |
| 8 | Iowa Brick Co., Des Moines, No. 3, top..... | .89 | .59 | 1.69 | 2.90 | 1.44 | 3.35 | 19.21 | 1.80 | 2.58 | 2.66 | 100.83 |
| 9 | Iowa Brick Co., Des Moines, No. 2, top..... | .63 | .65 | 1.95 | 1.00 | .86 | 3.83 | 11.94 | 1.65 | .90 | 4.33 | 99.57 |
| 10 | Flint Brick Co., Des Moines..... | .56 | .54 | 1.20 | 1.59 | 1.22 | 5.75 | 19.78 | 1.17 | 2.15 | 2.92 | 100.50 |
| 11 | M. E. Ward, Lake City, Iowa..... | .58 | .53 | 1.08 | 2.33 | 1.08 | 1.24 | 12.20 | 2.01 | | 5.15 | 100.70 |
| 12 | Capital City Brick & Pipe Co., Des Moines..... | 1.13 | .29 | 1.08 | 3.60 | 1.44 | 2.87 | 22.33 | 1.85 | 1.78 | 5.33 | 100.26 |
| 13 | Holman, Mark X..... | 1.59 | .50 | 1.15 | 2.15 | .86 | 2.59 | 14.17 | .95 | .76 | 5.16 | 100.31 |
| 14 | Holman, Sergeants Bluffs..... | .79 | .24 | .70 | 1.00 | .49 | 1.43 | 10.73 | .75 | 1.84 | 6.38 | 100.30 |
| 15 | Corey Pressed Brick Co., Lehigh, red burning..... | .96 | .90 | 2.04 | .30 | 2.04 | 3.83 | 23.05 | .99 | | 8.10 | 100.10 |
| 16 | Corey Pressed Brick Co., Lehigh..... | .79 | .84 | 2.19 | .96 | 1.70 | 3.83 | 23.89 | 1.18 | .26 | 5.87 | 100.17 |
| 17 | Granite Brick Co., Burlington, top..... | 1.13 | 1.44 | 2.79 | 3.65 | 3.13 | 2.40 | 5.16 | 1.30 | 1.44 | 1.49 | 100.29 |
| 18 | Granite Brick Co., Burlington, bottom..... | .42 | .86 | .78 | 3.18 | 3.80 | 3.35 | 11.41 | 1.25 | 3.02 | .87 | 100.52 |
| 19 | L. M. Harris, Rockford, bottom..... | .38 | 1.19 | 1.70 | 9.42 | 3.03 | 3.84 | 15.54 | 1.16 | | 3.47 | 100.06 |
| 20 | Capital City Brick & Pipe Co., Des Moines..... | 1.35 | 2.92 | .87 | 1.29 | 1.94 | 11.20 | 22.26 | .16 | | 7.43 | 100.30 |
| 21 | Capital City Brick & Pipe Co., Des Moines..... | .49 | 2.17 | 2.41 | 1.78 | 1.58 | 10.32 | 16.22 | | | 7.43 | 100.04 |
| 22 | Capital City Brick & Pipe Co., Des Moines..... | .88 | 1.04 | .54 | .81 | .42 | 3.36 | 16.39 | 1.42 | | 5.75 | 100.01 |
| 23 | Capital City Brick & Pipe Co., Des Moines..... | .51 | 2.81 | 2.76 | 1.59 | 1.55 | 5.52 | 17.90 | | | 5.02 | 100.00 |
| 24 | Capital City Brick & Pipe Co., Des Moines..... | .40 | 1.09 | 1.87 | .75 | 1.72 | 5.12 | 17.89 | | | 4.07 | 100.37 |
| 25 | | 6.77 | 1.25 | 3.70 | 4.05 | .94 | 8.64 | 17.71 | | 2.58 | | |
| 26 | Galesburg..... | 3.85 | 4.17 | 3.19 | 3.39 | .18 | 2.00 | 24.40 | | | 12.41 | 100.21 |
| 27 | | | | | | | | | | | | |
| 28 | Boone Brick Tile & Paving Co., Boone..... | 2.10 | 3.10 | .50 | .70 | 1.10 | 12.40 | 22.20 | 2.40 | | 7.90 | 99.80 |
| 29 | Buff Clay from Boone..... | .70 | .70 | .30 | 1.00 | 1.00 | 2.00 | 16.60 | 1.70 | | 4.30 | 99.90 |
| 30 | Red Clay from Ft. Dodge..... | 2.10 | 1.22 | 1.80 | 1.23 | 1.34 | 4.00 | 23.09 | | | 6.28 | 100.22 |
| 31 | Buff Clay from Ft. Dodge..... | 2.08 | 1.62 | .59 | 1.12 | 1.74 | 4.83 | 11.43 | .94 | | 11.50 | 100.06 |
| 32 | Buff Clay from Ft. Dodge..... | 1.15 | .81 | .49 | .92 | .62 | 2.72 | 17.26 | | | 5.57 | 99.98 |
| 33 | Clermont Brick & Tile Co..... | .43 | 5.38 | 7.41 | 19.14 | 5.40 | 3.78 | 10.37 | 3.01 | | 16.24 | 99.96 |
| 34 | Storm Lake Brick & Tile Co..... | 2.33 | 1.14 | 1.90 | 4.02 | 1.80 | 4.00 | 12.64 | | | 5.82 | 100.10 |
| 35 | Dale Brick Co., Des Moines..... | .32 | 1.84 | 1.77 | .45 | 1.36 | 5.12 | 17.73 | | | 4.21 | 100.17 |
| 36 | B. B. Jester, Danville..... | .22 | .32 | .38 | .73 | .45 | 2.72 | 15.54 | | | 4.97 | 100.15 |
| 37 | American Brick & Tile Co., Mason City..... | .42 | 1.43 | 2.59 | 4.14 | 3.36 | 7.50 | 18.34 | 2.76 | | 7.39 | 100.04 |
| 38 | Myron Mellen, Edgewood, Iowa..... | .89 | 1.56 | 5.29 | 7.88 | 6.05 | 7.80 | 13.72 | | | 12.18 | 100.00 |
| 39 | | | | | | | | | | | | |
| 40 | | | | | | | | | | | | |
| 41 | L. C. Besley, top..... | 1.05 | .55 | 1.89 | 7.20 | 3.15 | 3.83 | 6.53 | .90 | 5.53 | 2.05 | 99.99 |
| 42 | L. C. Besley, middle..... | .92 | .58 | 1.68 | 3.90 | 3.10 | 2.87 | 10.21 | 1.45 | 5.86 | 1.52 | 100.07 |
| 43 | L. C. Besley, bottom..... | 1.52 | .47 | 1.59 | 2.52 | 3.29 | 2.40 | 0.12 | 1.76 | 1.87 | 2.94 | 100.24 |
| 44 | Dale Brick Co., Des Moines..... | .71 | 1.27 | 2.72 | 1.53 | 1.01 | 5.56 | 9.68 | | | 3.88 | 99.85 |
| 45 | Getthmann Bros., Gladbrook, Iowa..... | 1.49 | 1.87 | 1.92 | 1.63 | 1.18 | 6.72 | 11.76 | | | 5.36 | 99.85 |
| 46 | Myron Mellen, Edgewood..... | 1.91 | 1.76 | .72 | 1.00 | 1.12 | 6.16 | 10.83 | | | 3.25 | 100.00 |
| 47 | Fort Dodge Stoneware Co..... | 1.00 | 1.06 | 1.92 | | 4.21 | 2.51 | 17.00 | | | 7.62 | 100.58 |
| 48 | Fort Dodge Stoneware Co..... | .37 | 1.35 | 2.74 | 3.00 | 4.09 | 1.12 | 15.25 | | | 9.31 | 100.82 |
| 49 | Marshalltown..... | .84 | 1.23 | .81 | .51 | .44 | 4.32 | 10.24 | | | 3.33 | 100.21 |
| 50 | Marshalltown..... | .98 | .64 | .55 | .99 | .42 | 4.32 | 20.21 | | | 8.50 | 100.00 |
| 51 | Clayton county..... | .22 | 1.25 | 2.77 | 19.86 | 4.81 | 5.04 | 14.59 | .68 | | 31.91 | 94.92 |
| 52 | Clayton county..... | 1.35 | 2.27 | 8.27 | 1.89 | 1.12 | 5.16 | 20.64 | .18 | 1.20 | 5.17 | 100.07 |
| 53 | A. W. Turner, Tabor, Iowa..... | .74 | 1.92 | 1.44 | 31.68 | 1.57 | 2.60 | 10.09 | .60 | | 30.16 | 100.25 |
| 54 | Geological Department..... | 3.02 | 2.62 | .43 | .12 | .45 | 4.32 | 29.28 | 1.22 | | 8.06 | 100.26 |
| 55 | Geological Department..... | 3.25 | 1.22 | .67 | .57 | .24 | 4.56 | 29.31 | .94 | | 10.38 | 100.14 |
| 56 | Geological Department..... | 2.49 | 1.82 | .98 | .82 | .71 | 7.92 | 24.63 | .16 | | 5.36 | 99.89 |
| 57 | Geological Department..... | .81 | 1.90 | 2.45 | .91 | .07 | 5.16 | 21.70 | .48 | | 6.95 | 99.87 |
| 58 | Geological Department..... | 1.85 | 1.52 | 1.06 | .46 | .86 | 9.38 | 23.79 | .35 | | 4.87 | 100.09 |
| 59 | | 3.48 | 3.44 | 3.54 | 1.74 | .90 | 7.92 | 24.43 | .09 | | 5.49 | 100.00 |
| 60 | O. J. Peterson..... | | | | | | | | | | | |
| 61 | Trenton Shale, Fayette county..... | 1.15 | 3.25 | 3.25 | 14.97 | 3.94 | 4.80 | 15.38 | 1.62 | | 18.01 | 99.97 |
| 62 | Fred Hanson, Eldora..... | 2.48 | 1.08 | .77 | .48 | .48 | 1.08 | 16.24 | .14 | | 5.18 | 100.00 |
| 63 | West Union, Iowa..... | | | | 3.87 | 1.81 | | | | 2.44 | | |
| 64 | West Union, Iowa..... | 2.18 | 1.79 | 1.33 | 1.20 | 1.87 | 3.48 | 15.29 | .61 | | 4.83 | 99.80 |
| 65 | Volunteer Coal Co., What Cheer..... | .84 | 1.93 | 1.49 | .65 | .39 | 2.22 | 22.06 | .79 | | 6.92 | 99.94 |

RATIONAL ANALYSES OF CLAYS.

| Number. | SAMPLE FROM— | | | | |
|---------|--|-------|---------|-----------|---|
| | | Clay. | Quartz. | Feldspar. | Carbonates and sul- fates of calcium and magnesium. |
| 1 | Flint Brick Company, Des Moines, bottom | 52.85 | 25.99 | 15.80 | 5.36 |
| 2 | Flint Brick Company, Des Moines, middle | 59.12 | 9.59 | 25.32 | 5.97 |
| 3 | Flint Brick Company, Des Moines, top | 53.79 | 33.31 | 8.78 | 4.14 |
| 4 | Iowa Brick Company, Des Moines, No. 7, bottom | 56.79 | 19.63 | 21.96 | 1.62 |
| 5 | Iowa Brick Company, Des Moines, No. 6, top | 31.00 | 30.56 | 32.77 | 5.67 |
| 6 | Iowa Brick Company, Des Moines, No. 5, top | 60.70 | 36.97 | 2.33 | |
| 7 | Iowa Brick Company, Des Moines, No. 4, top | 70.66 | 21.79 | 3.95 | 3.60 |
| 8 | Iowa Brick Company, Des Moines, No. 3, top | 49.30 | 34.01 | 13.09 | 3.60 |
| 9 | Iowa Brick Company, Des Moines, No. 2, top | 41.47 | 55.29 | 3.24 | |
| 10 | Flint Brick Company, Des Moines, brick | 61.57 | 20.53 | 13.47 | |
| 11 | M. E. Ward, Lake City | 42.00 | 46.16 | 8.44 | 3.40 |
| 12 | Capital City Brick and Pipe Company, Des Moines | 57.40 | 31.17 | 4.38 | 7.05 |
| 13 | Holman, Mark X | 46.44 | 46.51 | 3.80 | 3.25 |
| 14 | Holman, Sargeants Bluff | 38.20 | 51.10 | 7.62 | 3.08 |
| 15 | Corey Pressed Brick Company, Lehigh, red burning | 68.20 | 25.81 | 5.99 | |
| 16 | Corey Pressed Brick Company, Lehigh | 54.62 | 32.23 | 11.13 | 1.97 |
| 17 | Granite Brick Company, Burlington, top | 24.92 | 51.39 | 19.64 | 4.05 |
| 18 | Granite Brick Company, Burlington, bottom | 35.82 | 42.14 | 14.18 | 7.76 |
| 19 | L. M. Harris, Rockford, bottom | 64.47 | 18.67 | 11.13 | 5.73 |
| 20 | Capital City Brick and Pipe Company, Des Moines | 51.53 | 44.05 | 4.42 | |
| 21 | Capital City Brick and Pipe Company, Des Moines | 44.49 | 45.97 | 9.54 | |
| 22 | Capital City Brick and Pipe Company, Des Moines | 44.12 | 47.31 | 8.57 | |
| 23 | Capital City Brick and Pipe Company, Des Moines | 39.79 | 50.49 | 9.72 | |
| 24 | Capital City Brick and Pipe Company, Des Moines | 38.00 | 50.81 | 11.19 | |
| 25 | | | | | |
| 26 | Galesburg | 83.57 | 8.83 | 7.60 | |
| 28 | Boone Brick, Tile and Paving Company | 74.90 | 12.70 | 8.81 | 3.59 |
| 29 | Buff clay from Boone | 37.13 | 47.54 | 15.33 | |
| 30 | Red clay from Fort Dodge | 59.23 | 38.47 | 2.50 | |
| 31 | Buff clay from Fort Dodge | 55.86 | 34.73 | 8.31 | 1.60 |
| 32 | Buff clay from Fort Dodge | 47.47 | 47.50 | 5.03 | |
| 33 | Clermont Brick and Tile Company | 68.20 | 21.75 | 4.98 | 5.12 |
| 34 | Storm Lake Brick and Tile Company | 38.80 | 36.36 | 24.84 | |
| 35 | Dale Brick Company, Des Moines | 40.31 | 47.09 | 12.60 | |
| 36 | B. B. Jester, Danville, Iowa | 21.77 | 68.94 | 9.29 | |
| 37 | American Brick and Tile Company, Mason City | 47.08 | 41.45 | 6.98 | 4.49 |
| 38 | Myron Mellen, Edgewood | 40.61 | 28.00 | 4.62 | 23.77 |
| 39 | | | | | |
| 40 | | | | | |
| 41 | L. C. Besley, top of pit | 26.51 | 32.77 | 28.34 | 12.34 |
| 42 | L. C. Besley, middle | 19.72 | 40.29 | 25.74 | 14.25 |
| 43 | L. C. Besley, bottom | 27.37 | 46.09 | 19.32 | 7.22 |
| 44 | Dale Brick Company, Des Moines | 31.30 | 56.23 | 12.47 | |
| 45 | Gethmann Brothers, Gladbrook | 39.91 | 40.28 | 19.82 | |
| 46 | Myron Mellen, Edgewood | 33.55 | 50.39 | 11.06 | |
| 47 | Fort Dodge Stoneware Company | 29.00 | 59.94 | 11.06 | |
| 48 | Fort Dodge Stoneware Company | 35.18 | 44.41 | 20.41 | |
| 56 | Marshalltown | 14.81 | 38.98 | 43.21 | |
| 57 | Marshalltown | 41.10 | 46.68 | 12.22 | |
| 58 | Clayton County | 84.74 | 10.23 | 5.03 | |
| 59 | Clayton County | 70.65 | 26.73 | 2.57 | |
| 60 | A. W. Turner, Tabor, Iowa | | | | |
| 61 | Geological Department | 58.64 | 35.09 | 6.27 | |
| 62 | Geological Department | 51.46 | 42.22 | 6.32 | |
| 63 | Geological Department | 41.20 | 44.61 | 14.19 | |
| 64 | Geological Department | 50.20 | 26.22 | 23.58 | |
| 65 | Geological Department | 45.36 | 41.91 | 12.73 | |
| 66 | | 67.92 | 24.34 | 7.74 | |
| 67 | O. J. Peterson | 43.97 | 25.03 | 31.00 | |
| 68 | Trenton shale, Fayette County | 66.59 | 18.95 | 14.55 | |
| 69 | Fred Hanson, Eldora | | | | |
| 70 | West Union, Iowa | | | | |
| 71 | West Union, Iowa | | | | |
| 72 | Volunteer Coal Company, What Cheer | 40.11 | 54.37 | 5.52 | |

SELECTION, INSTALLATION AND
CARE OF POWER PLANTS.

BY

G W. BISSELL.

SELECTION, INSTALLATION AND CARE OF POWER PLANTS

BY G. W. BISSELL.

CONTENTS.

| | Page |
|---|------|
| Selection of power plants..... | 350 |
| Requirements | 350 |
| The power house..... | 351 |
| Machinery | 352 |
| Boilers | 352 |
| Desirable types..... | 353 |
| Shaking grate..... | 353 |
| Specifications for horizontal return tubular boiler 72 in. by 18 ft | 356 |
| Dimensions | 356 |
| Material | 356 |
| Tubes and braces..... | 356 |
| Riveting | 356 |
| Construction | 357 |
| Openings | 357 |
| Castings | 357 |
| Fittings | 357 |
| Inspection and test..... | 357 |
| Alternate specifications for boiler 66 in. by 18 ft | 358 |
| Boiler feeding..... | 361 |
| Cold feed-water..... | 362 |
| Feed-water heaters | 362 |
| Open..... | 364 |
| Closed | 364 |
| Advantages of the open heater | 365 |
| Construction of the open heater..... | 366 |
| Requirements of the open heater..... | 367 |

| | Page |
|--|------|
| Firing | 369 |
| Analyses of Iowa coals | 370 |
| General characteristics of Iowa coals | 370 |
| Calorific power of Iowa coals and other fuels. | 371 |
| Methods of firing..... | 372 |
| Engines..... | 373 |
| Proportions to be observed in selection | 373 |
| Effective power calculated..... | 373 |
| Foundation for engine..... | 374 |
| Minor items..... | 374 |
| Lagging of steam pipes, fitting, etc..... | 374 |
| Self-oiling bearings..... | 374 |
| Transmission belts | 375 |
| Use of exhaust steam in heating drying room | 375 |
| Ventilation..... | 376 |

CHAPTER VI.

Selection of Power Plants.

It is the purpose of this report to state and discuss the principles governing the selection and installation of the engines and boiler plant which furnish the power required for working clay into brick and other marketable products.

The writer has assumed that in the selection of the power producing apparatus the following requirements exist: All machinery must be (1) simple in design, (2) strong in construction, (3) reliable in action, (4) reasonable in first cost, and (5) readily handled by men of ordinary intelligence and some mechanical aptitude.

To these requirements should be added a sixth, that of economical operation. It should be noted that the fourth and fifth requirements first enumerated may conflict with the sixth. It is the desire of the writer to impress upon clay workers the idea that the sixth requirement is very important.

By economy of operation in this connection is meant low annual expenses chargeable to power production. The items of such expense are:

(1) Fixed charges, (2) current expenses, (3) repairs.

Fixed charges include: (a) interest on the investment, (b) depreciation, (c) taxes, (d) insurance.

Current expenses include: (a) fuel, (b) labor, (c) supplies.

Repairs include: (a) labor, (b) material.

In order that the sum total of all the items shall be a minimum considerable thought should be given to the design, in general and detail, of the plant; and subsequently its operation.

The Power House.

The building in which engines and boilers and accessories are placed need not be elaborate or expensive, but should be so constructed as to protect the machinery and its attendants from the

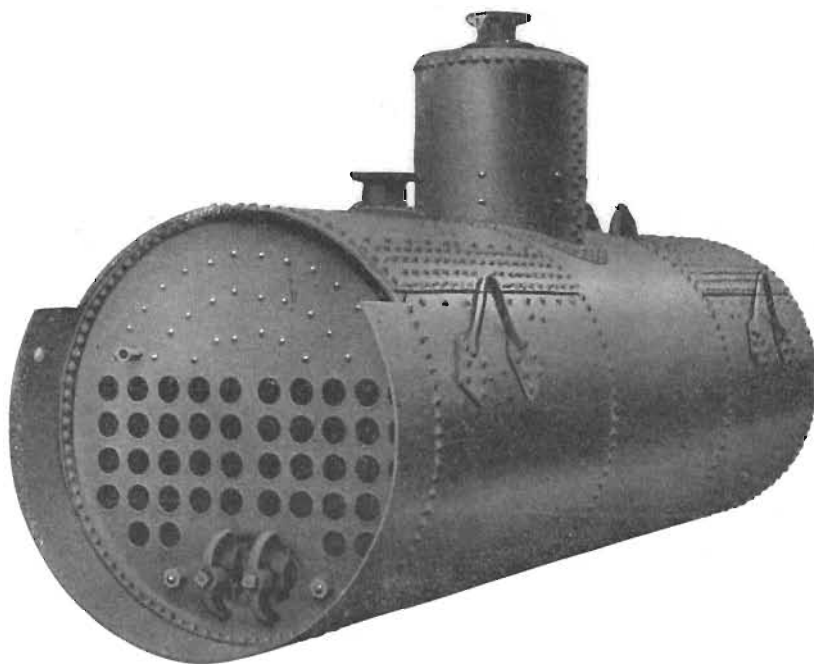

FIG. 31. Boiler with dome, shell extended for full front, wrought iron hinges.

weather while the plant is in use, should protect the machinery from meddling persons and the weather while the plant is not in use and should be located and the machinery arranged therein so that the capacity of the plant can be increased by adding to the existing building. Plenty of light and controllable ventilation are very desirable in the power house.

Machinery.

This consists usually of engines, boilers and stacks, and feed-pumps or injectors. For most localities feed water purifiers should be added to the list.

The assumption is made here that the exhaust steam from the engine is used for drying the clay previous to burning.

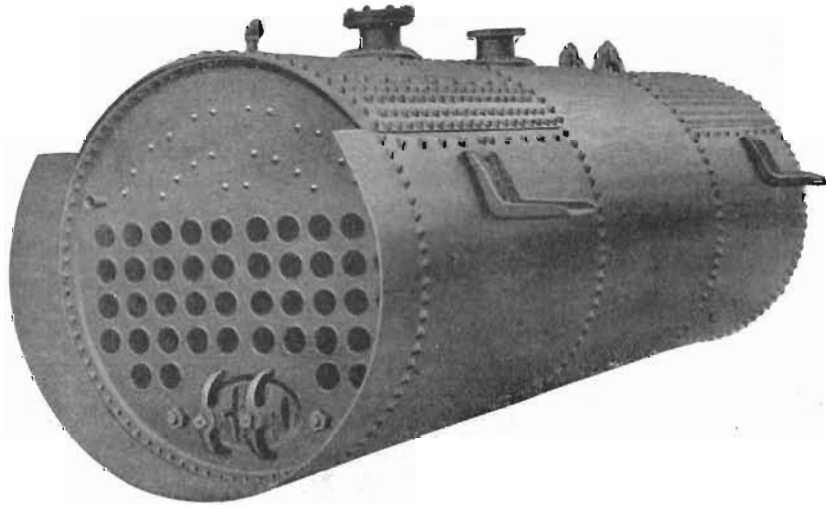

FIG. 32. Domeless boiler with nozzles, shell extended for full front, pressed steel lugs.

BOILERS.

The most satisfactory all around boiler is the well known horizontal return tubular boiler shown without the brick work and castings in Figs. 31 and 32 and Plate XI. Fig. 31 represents a boiler adapted to suspension, to which reference is made

below. For Iowa coal as fuel this boiler should have relatively long tubes, should be set high above the grates, should have liberal grate surface and be connected to a stack of ample capacity.

It would be desirable in large plants to consider the use of a coking arch or, better, the "dutch oven."

Tubes 4 inches in diameter should be 18 to 20 feet long and 3½-inch tubes should be 16 feet long. Tubes smaller than 4 inches are not advisable for natural draft with Iowa coals, on account of the excessive soot accumulation in smaller tubes. With tubes of the lengths mentioned, the hot gases from the furnace will travel far enough in contact with water heating surface to reduce their temperature at the stack to a reasonable point, say 350 degrees to 450 degrees F.

The grate surface should be liberal so as to permit the use of slack or the carrying of a heavy enough fire of any grade of Iowa coal to compel a thorough mixture of the air and combustible gases of the fuel.

Twelve square feet of water heating surface per boiler horse power, and one square foot of water heating surface per boiler horse power, and one square foot of grate surface to each forty square feet of heating surface will be found satisfactory. Rocking or shaking grates are very desirable. An excellent shaking grate is shown in Fig. 33. This gives excellent results with the slack and other steam coals mined in Iowa.

Automatic stokers are not practicable in plants of less than 400 to 500 horse power capacity, because no saving in labor is possible, and the saving, if any, due to improved combustion, is offset by repairs to the stokers, and the power required to operate them.

Most boiler shells are too near the fire for the economical use of Iowa coal; in fact, the best conditions exist where, as with the coking arch or the "dutch oven," there is no water heating surface in the fire-box or furnace. With the standard surface a 72-

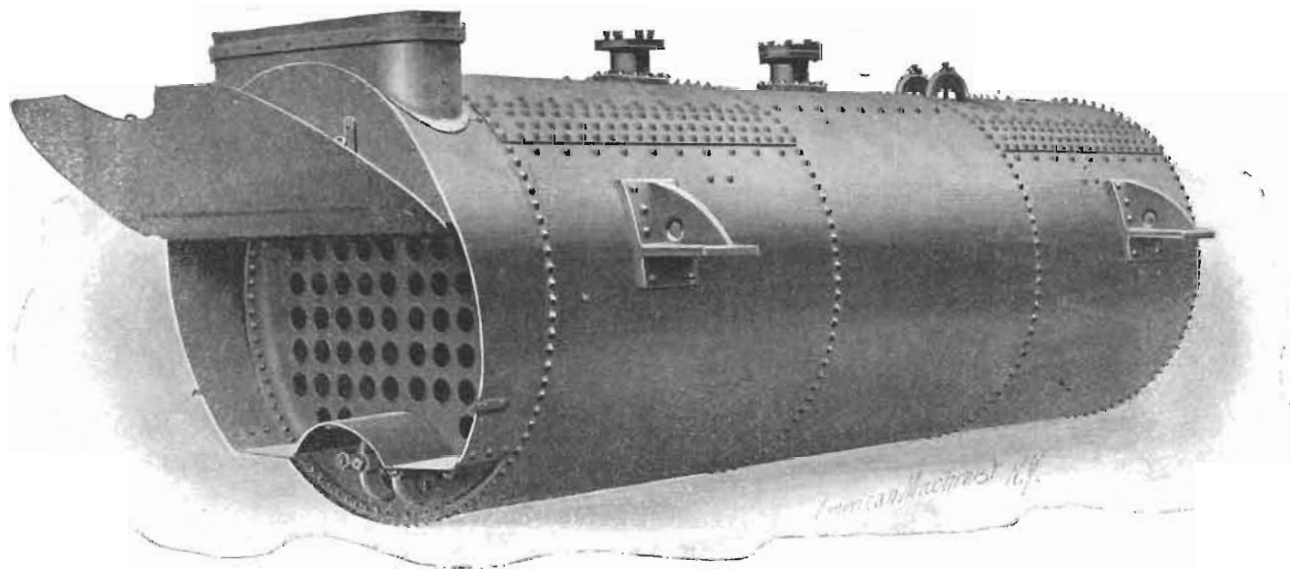

PLATE XI. Domeless boiler with nozzles, shell extended and fitted with flue door and up-take for half-arch front, manhole exposed, cast iron lugs; can be suspended.

inch boiler should be not less than 42 inches above the grate. Table No. 1 contains approved dimensions for boilers of this type for shells from 48 inches to 72 inches in diameter, and from 16 feet to 20 feet in length, with 4-inch tubes.

TABLE No. 1.

| | | | | | | |
|--------------------------------|-------------------|-------------------|-------------------|-------------------|-------------------|------|
| Diameter of boiler..... | 48" | 54" | 60" | 66" | 72" | |
| Number of tubes..... | 24 | 36 | 44 | 54 | 68 | |
| Diameter of tubes..... | 4" | 4" | 4" | 4" | 4" | |
| Thickness of shell..... | $\frac{5}{16}$ " | $\frac{5}{16}$ " | $\frac{5}{16}$ " | $\frac{3}{8}$ " | $\frac{3}{8}$ " | |
| Thickness of head..... | $\frac{1}{2}$ " | $\frac{1}{2}$ " | $\frac{1}{2}$ " | $\frac{1}{2}$ " | $\frac{1}{2}$ " | |
| Braces above tubes..... | 12 | 20 | 30 | 30 | 40 | |
| Braces below tubes..... | 4 | 4 | 4 | 4 | 8 | |
| Size of steam pipe..... | 3 $\frac{1}{2}$ " | 4" | 4 $\frac{1}{2}$ " | 5" | 6" | |
| Size of feed pipe..... | 1 $\frac{1}{2}$ " | 1 $\frac{1}{2}$ " | 1 $\frac{1}{2}$ " | 1 $\frac{1}{2}$ " | 1 $\frac{1}{2}$ " | |
| Size of blow-off pipe..... | 2" | 2" | 2" | 2 $\frac{1}{2}$ " | 2 $\frac{1}{2}$ " | |
| | sq. ft. | sq. ft. | sq. ft. | sq. ft. | sq. ft. | |
| Heating surface..... | { 16 ft | 520 | 715 | 864 | 1042 | 1325 |
| | { 18 ft | 585 | 805 | 972 | 1270 | 1490 |
| | { 20 ft | 650 | 894 | 1080 | 1305 | 1656 |
| Rated horse power..... | { 16 ft | 43.3 | 59.5 | 72 | 87 | 110 |
| | { 18 ft | 48.7 | 67 | 81 | 90 | 124 |
| | { 20 ft | 54 | 74.5 | 90 | 109 | 138 |
| Grate surface..... | { 16 ft | 14 | 18 | 21.6 | 30 | 33 |
| | { 18 ft | 15.8 | 22 | 24.3 | 33 | 39.6 |
| | { 20 ft | 17.5 | 24 | 27 | 33 | 43 |
| Diameter of 60-foot stack..... | 4" | 27" | 30" | 33" | 36" | |

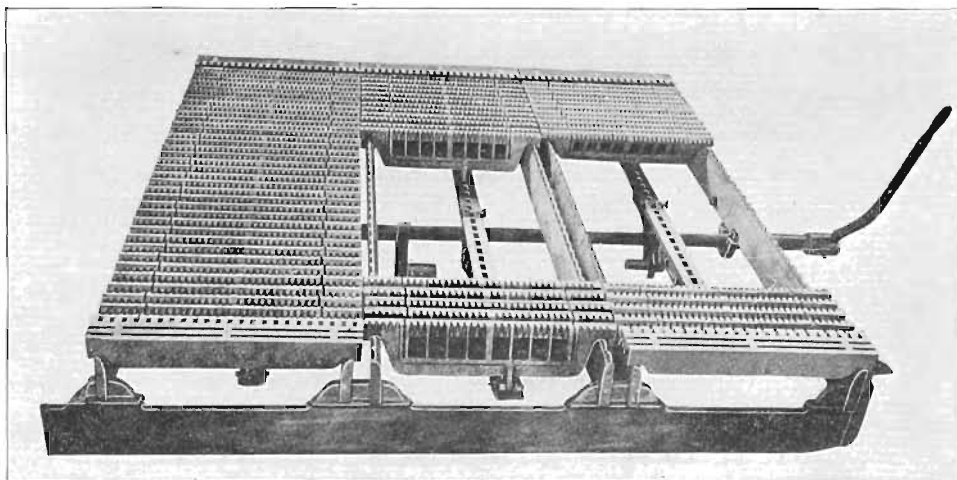

FIG. 93. A good type of rocking grate.

Herewith is a standard "Specification" for boilers of the same type, based upon the practice recommended by the Hartford Steam Boiler Inspection and Insurance Company. The principal departure therefrom consists in the overhead suspension mentioned as an alternate to the common method of supporting the boiler on the brick work.

SPECIFICATIONS FOR HORIZONTAL RETURN TUBULAR BOILER, 72 IN. BY 18 FT.

Type.—Horizontal return tubular.

Dimensions.—Seventy-two inches in diameter, eighteen feet long from outside to outside of heads, with smoke extensions eighteen inches long continuous with shell. Thickness of shell, three-eighths inch, of head one-half inch.

Material.—Best open hearth flange steel, having a tensile strength of not less than 57,000 nor more than 62,000 pounds, and ductility corresponding to 56 per cent reduction of area and 25 per cent of elongation. All plates in finished boiler to show stamp with name of maker, quality and tensile strength.

Tubes and Braces.—Sixty-eight tubes, four (4) inches in diameter, 18 feet long, best lap welded or seamless drawn, carefully and properly expanded with Dudgeon expander and beaded at each end. Braces: 44 braces above tubes and four below tubes, the former crow foot form, flat or round, of not less than one square inch in area at smallest section, the latter $1\frac{1}{4}$ inches in diameter, with up-set ends for $1\frac{1}{2}$ -inch thread at front and crow-foot connections at back, with turned bolt 1 1-16-inch diameter. No brace less than 3 feet 6 inches long.

Details of tube sheet lay-out to be according to practice recommended by the Hartford Steam Boiler Inspection and Insurance Company.

Riveting.—Two lugs on each side. Front lugs to rest on cast iron plates, others on rollers and plates to permit of expansion. All plates 12 by 12 by $1\frac{1}{2}$. Rollers 1 inch diameter, 9 inches

long, three at each plate. Or two suspension loops on each side, of 1½-inch round iron securely riveted to shell. See Fig. 31.

Construction.—No dome. Shell in three rings, each ring formed from a single sheet, horizontal seams above the fire and to break joints. Heads machine flanged, rivet holes drilled or punched and reamed, tube holes drilled or bored.

Openings.—Two man-holes, 11 by 15 in top of shell, 10 by 15 in front head, under tube. 1½-inch feed-water pipe, internal from front head over tubes. Blow-off flange 2½ inches. Steam nozzle 5 inches, near back end, safety valve nozzle, 4 inches, near front end. Both nozzles flanged and fitted with companion flanges for screwed pipe of same size as nozzle.

Castings.—Fronts. Ornamental three-quarter arch for overhanging extension. Fronts designed to allow not less than 36 inches between grate and boiler shell and to have fire-door frames for 8-inch wall. Tight fitting fire, ash-pit and smoke extension doors, saddle for breaching connection with balanced butterfly damper, or columns and double channels for overhead suspension, with equalizing I-beam at back end.

Eight wall binders, binder rods, anchor rods for front, soot door and skeleton frames for fire brick arch at back.

Uptake 14 by 60.

Rocking or shaking grates of approved design to work from front of boiler.

Fittings.—Eight-inch brass steam gauge, combination water column, 4-inch pop safety valve, 1½-inch check and stop valves and 2½ inch asbestos blow-off cock.

Inspection and Test.—Before shipment test with cold water at 150 pounds per square inch and furnish certificate of inspection from the Hartford Steam Boiler Inspection and Insurance Co. and insurance policy in the same company for one year in the sum of \$2,000.00 for both boilers.

ALTERNATE SPECIFICATIONS FOR BOILER 66 IN. BY 18 FT.

Complying with specifications for the 72-inch boiler, except as follows:

Diameter, 66 inches. Length, outside to outside, 18 feet.

Thickness of shell, $\frac{3}{8}$ inch. Riveting, double riveted lap for longitudinal seams.

54 tubes, 4 inches by 18 feet.

Braces above tubes, 34.

Braces below tubes, 4.

Uptake, 12 by 54.

Steam pipe, $4\frac{1}{2}$ inch. Safety valve, $3\frac{1}{2}$ inch.

Blow off, 2 inch.

Feed pipe, $1\frac{1}{2}$ inch.

ALTERNATE SPECIFICATIONS FOR BOILER 60 IN. BY 18 FT.

Complying with the specifications for the 72-inch boiler, except as follows:

Diameter, 60 inches. Length, outside to outside, 18 feet.

Thickness of shell, 5-16 inch. Riveting, double riveted lap for longitudinal seams.

44 tubes, 4 inches by 18 feet.

Braces above tubes, 30.

Braces below tubes, 4.

Uptake, 12 by 42.

Steam pipe, 4 inch. Safety valve, $3\frac{1}{2}$ inch.

Blow off, 2 inch.

Feed pipe, $1\frac{1}{4}$ inch.

Complete specifications and setting plans for any size of horizontal return tubular boiler can be had by applying to the Hartford Steam Boiler Inspection and Insurance Co. In the judgment of the writer, they should be modified along the lines suggested in the above specifications.

The capacity of the stack depends upon its cross-sectional area, its height, the temperature inside and outside and general atmospheric conditions.

Table No. 2, adapted from a more complete table in Snow's "Steam Boiler Practice", p. 236, gives the capacities in horse power of chimneys or stacks of various heights and diameters for ordinary conditions as to temperature of the hot gases and for average atmospheric conditions.

TABLE No. 2

| INSIDE DIAMETER INCHES. | EFFECTIVE AREA SQ. FT. | HEIGHT OF CHIMNEY IN FEET. | | | | |
|-------------------------------|------------------------------|----------------------------|-----|-----|-------|-------|
| | | 60 | 80 | 100 | 125 | 150 |
| 18 | 0.97 | 25 | 29 | | | |
| 24 | 2.08 | 54 | 62 | | | |
| 30 | 3.58 | 92 | 107 | 119 | | |
| 36 | 5.47 | 141 | 163 | 182 | 204 | |
| 42 | 7.76 | | 231 | 258 | 289 | 316 |
| 48 | 10.44 | | | 348 | 389 | 426 |
| 54 | 13.51 | | | 449 | 503 | 551 |
| 60 | 16.98 | | | 565 | 632 | 692 |
| 84 | 34.76 | | | | 1,294 | 1,418 |

A substantial brick stack is better than an unlined steel stack such as is commonly furnished with boilers, but a self supporting steel stack lined to the top with brick is considered good and costs somewhat less than an all-brick stack.

For Iowa feed-water the boiler should be made as accessible as possible for interior examination and cleaning. To this end a man-hole below as well as above the tubes is a necessity.

A dome is not necessary, and its cost can be saved by omitting it from the specifications.

The feed-water should be introduced at the front and above the tubes, below the water line, into a pipe extending to within two feet of the back head, and discharged downwards between the tubes and the shell.

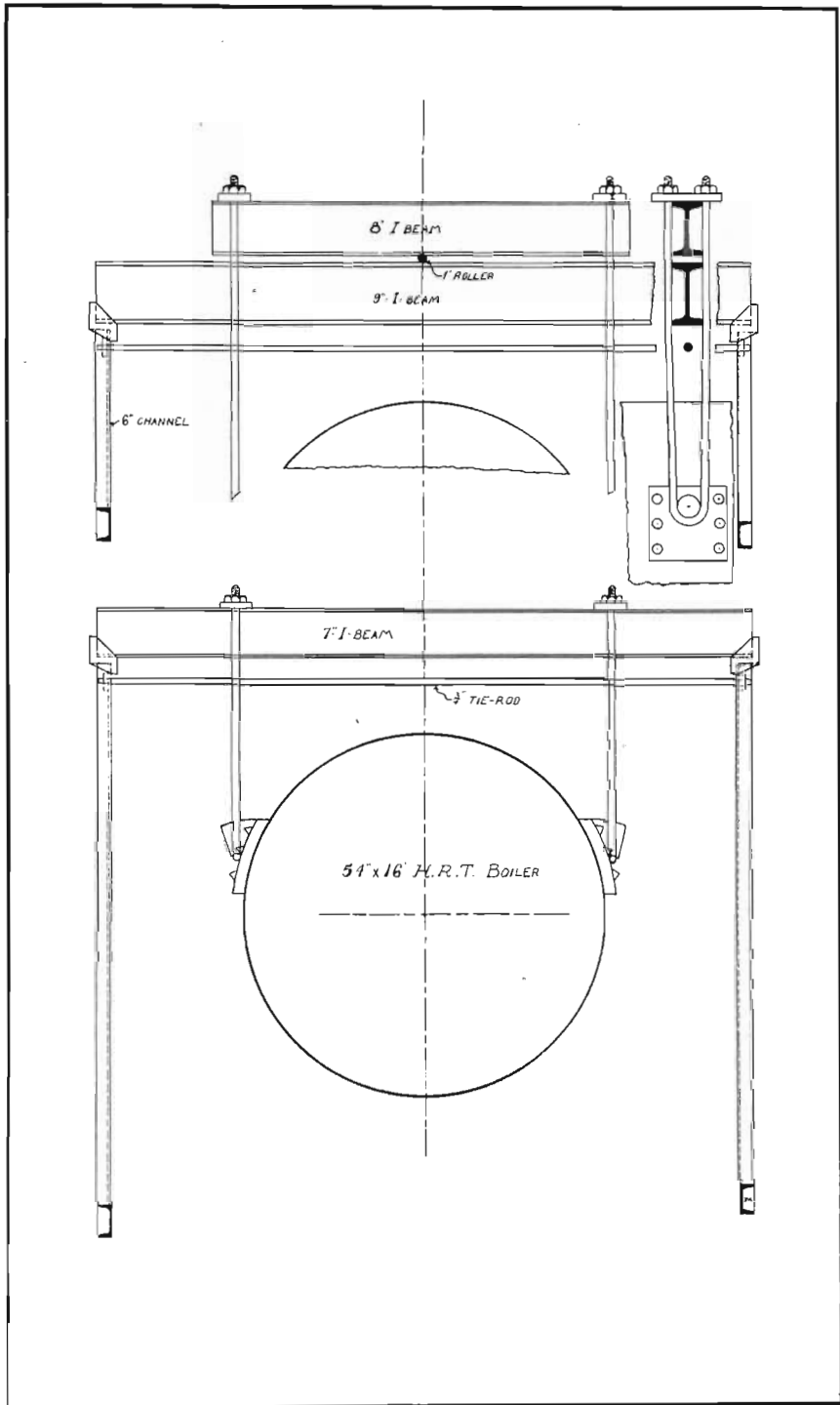

PLATE XII. Method of hanging a shell boiler.

SETTING FOR ONE 72 INCH
HORIZONTAL TUBULAR BOILER
WITH OVEN FURNACE
DESIGNED BY
HARTFORD STEAM BOILER INSP'N & INS CO
HARTFORD, CONN
NOVEMBER 1901
SCALE 1/2" = 1'
*3271

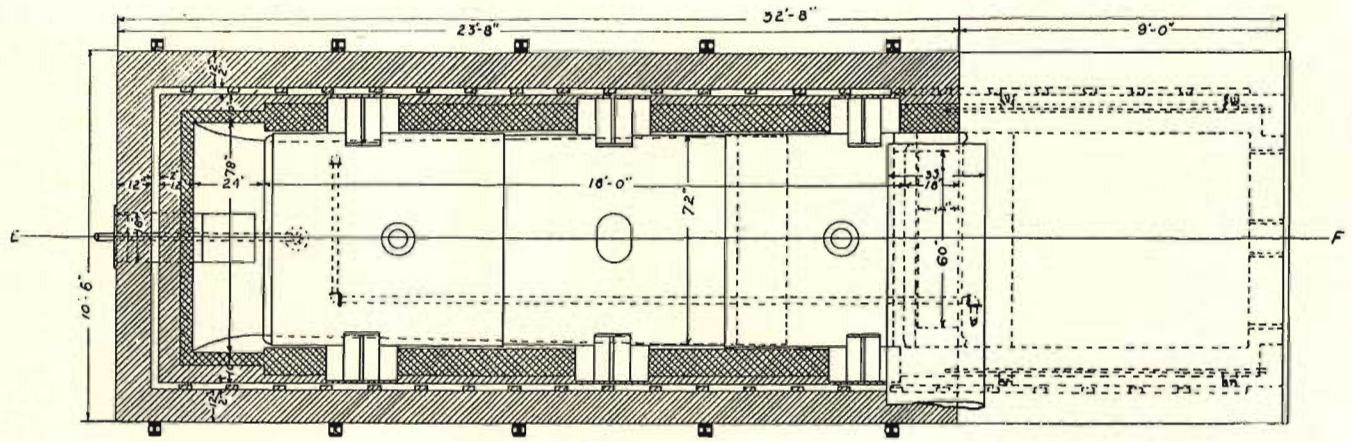

FIG 1.

HORIZONTAL SECTION OF WALLS AT A-B FIGS 2 3

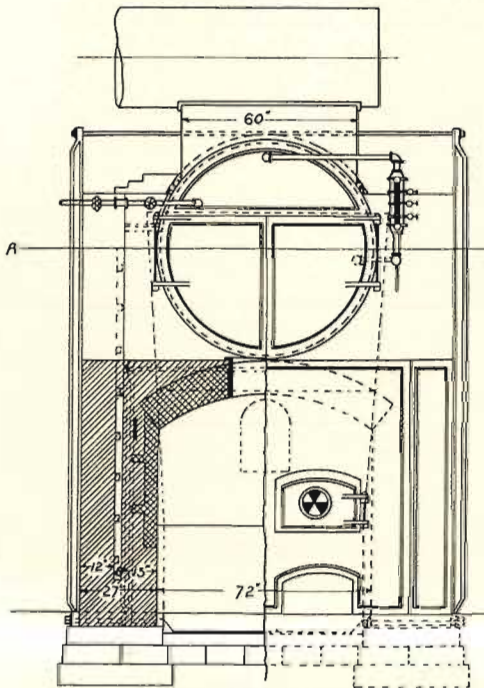

FIG 2

TRANSVERSE SECTION OF
WALLS AT C-D FIG 3
HALF FRONT ELEVATION

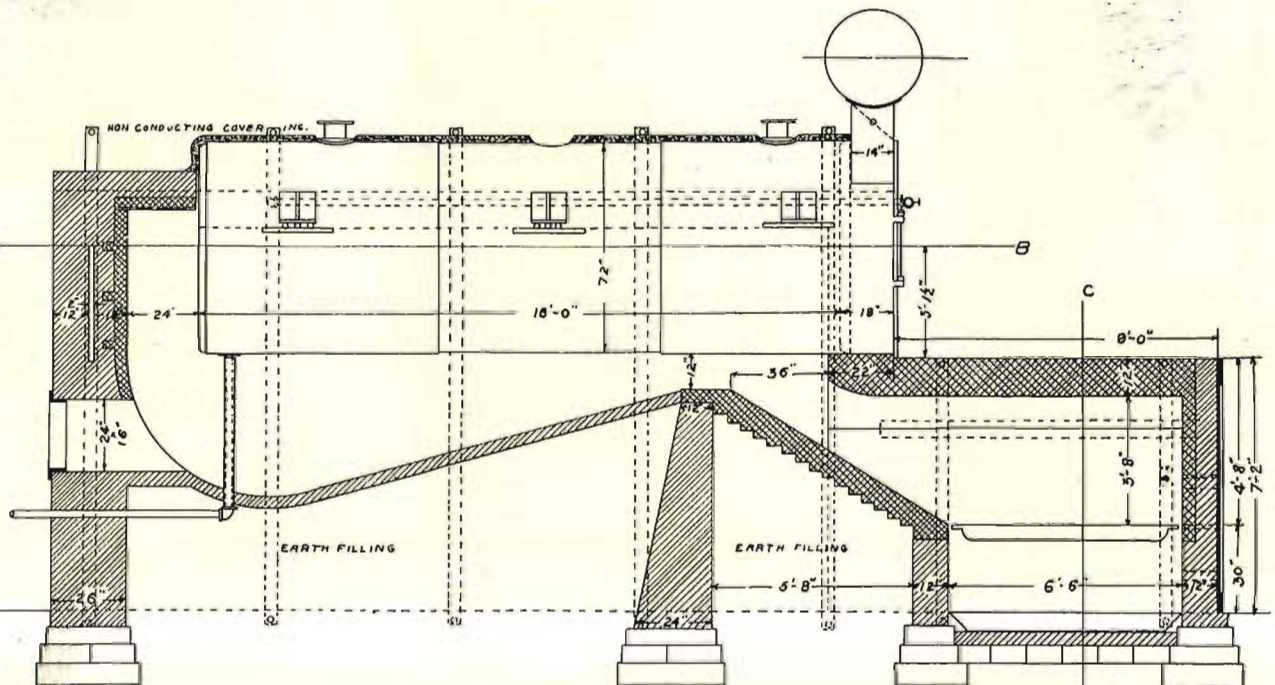

FIG 3.

LONGITUDINAL SECTION OF WALLS AT E-F FIGS 1-2

The boiler should be hung on columns by means of equalizing levers and hangers, so as to keep the shell free from strains due to settling of the brick work.

A method of hanging a shell boiler which can be applied to a boiler of any size is shown in Plate XII as designed by the writer for a 54-inch boiler, 16 feet long.

Plate XIII shows the construction of a "dutch oven" for a 72-inch by 18-foot boiler. The dimensions are governed in part by the size of the grate, but the thickness of the brick work would be practically the same for all sizes.

The construction should be very substantial in order to stand the high temperature.

Plate XIV shows the standard setting plans for a 72-inch by 18-foot boiler. For other sizes the thickness of walls would be the same, but the general dimensions would conform to the size of the boiler shell, as shown in Fig. 32. The overhanging front shown is better than the flush front. Two lugs on each side would be better than three, as shown.

BOILER FEEDING.

The most reliable boiler feeder is a direct acting single or duplex pump as illustrated in Figures 34 and 35, and Plate XV.

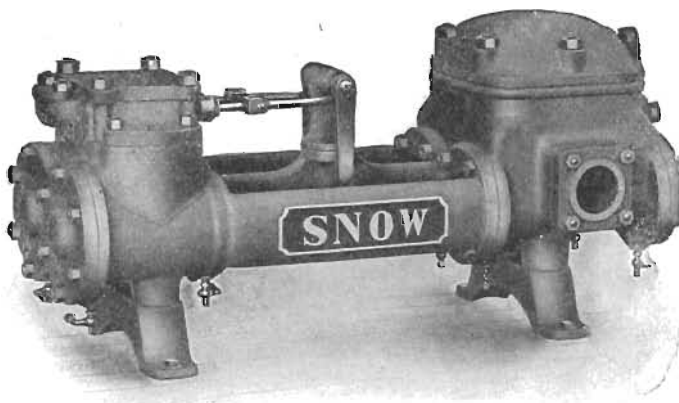

FIG. 34. Type of boiler feed-pump; duplex.

The exhaust therefrom can be used to help in the heating of the feed-water as explained later. A second pump, or an injector, should be installed in reserve.

The use of cold feed-water, where it can be heated by otherwise waste heat, is uneconomical. It is perfectly practicable by means of exhaust steam from the auxiliary engines (pumps), or the main engine, to heat the feed-water to 200 degrees F., or even 210 degrees F. This will effect a saving of 10 per cent or more in the fuel consumed by the boiler.

The use of cold feed-water is also bad for the boiler, because of sudden strains thrown upon the shell plates and seams, which lessen the life of the boiler.

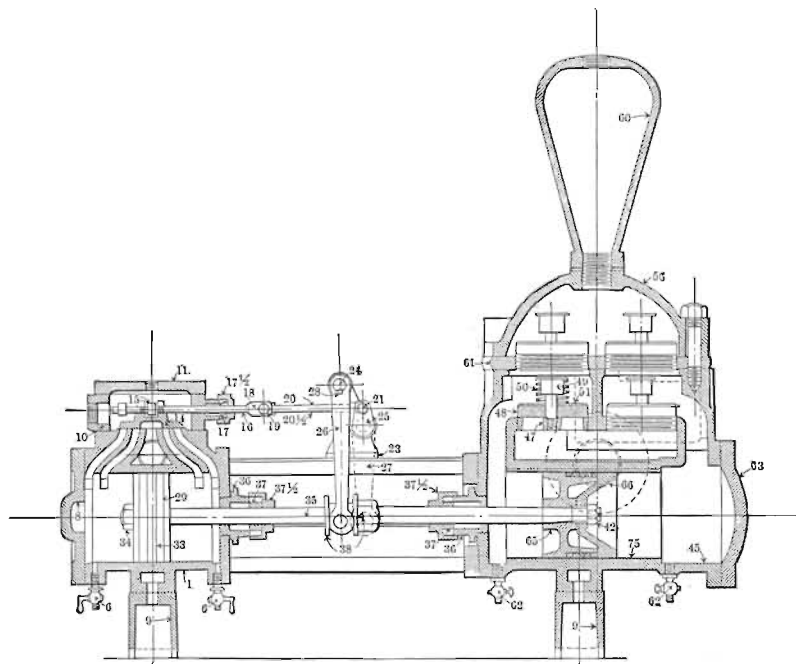

FIG. 35. Duplex pump in section.

Feed-water heaters can be built so that they will act as purifiers. Carbonates of lime and some other solids are precipitated from water which is heated to about 180 degrees F., and in some cases nearly complete purification would result.

SETTING FOR ONE 72 INCH
HORIZONTAL TUBULAR BOILER.

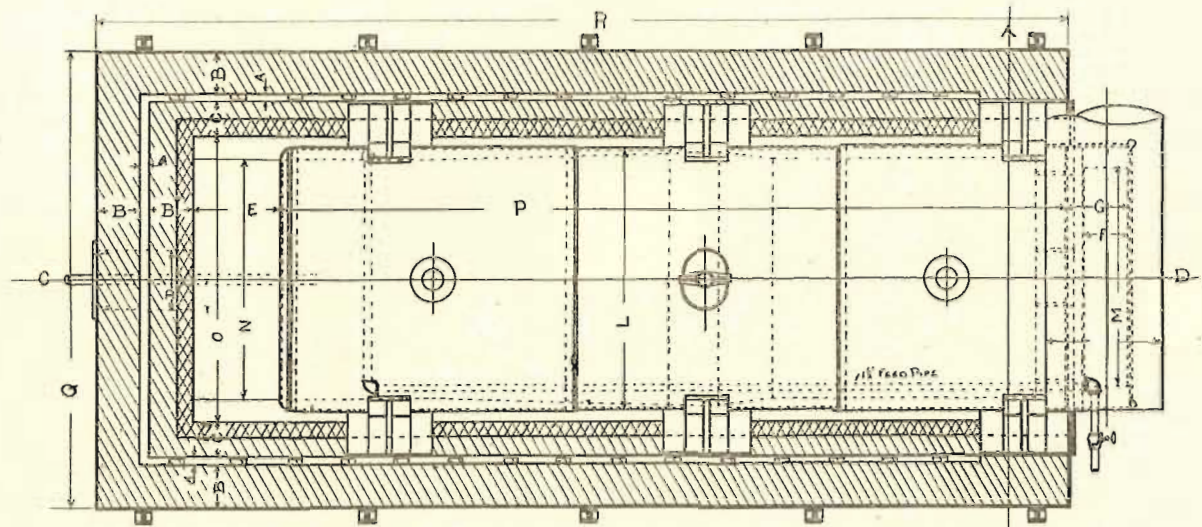

FIG. 1.
HORIZONTAL SECTION OF WALLS AT 'E-F' FIGS 2 & 3.

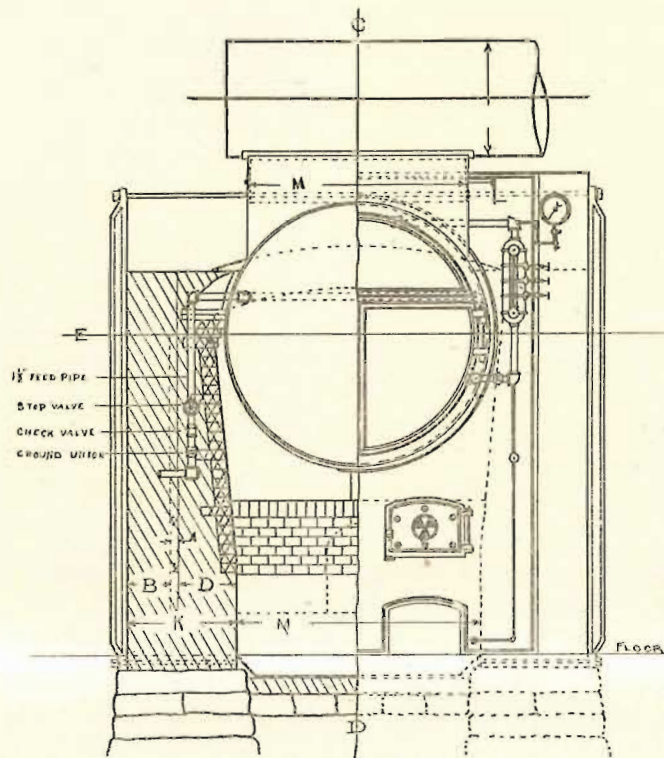
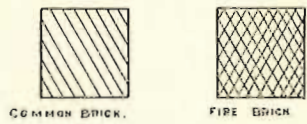

FIG. 2.

TRANSVERSE SECTION OF WALLS FRONT ELEVATION
AT 'A-B' FIGS. 1 & 3.

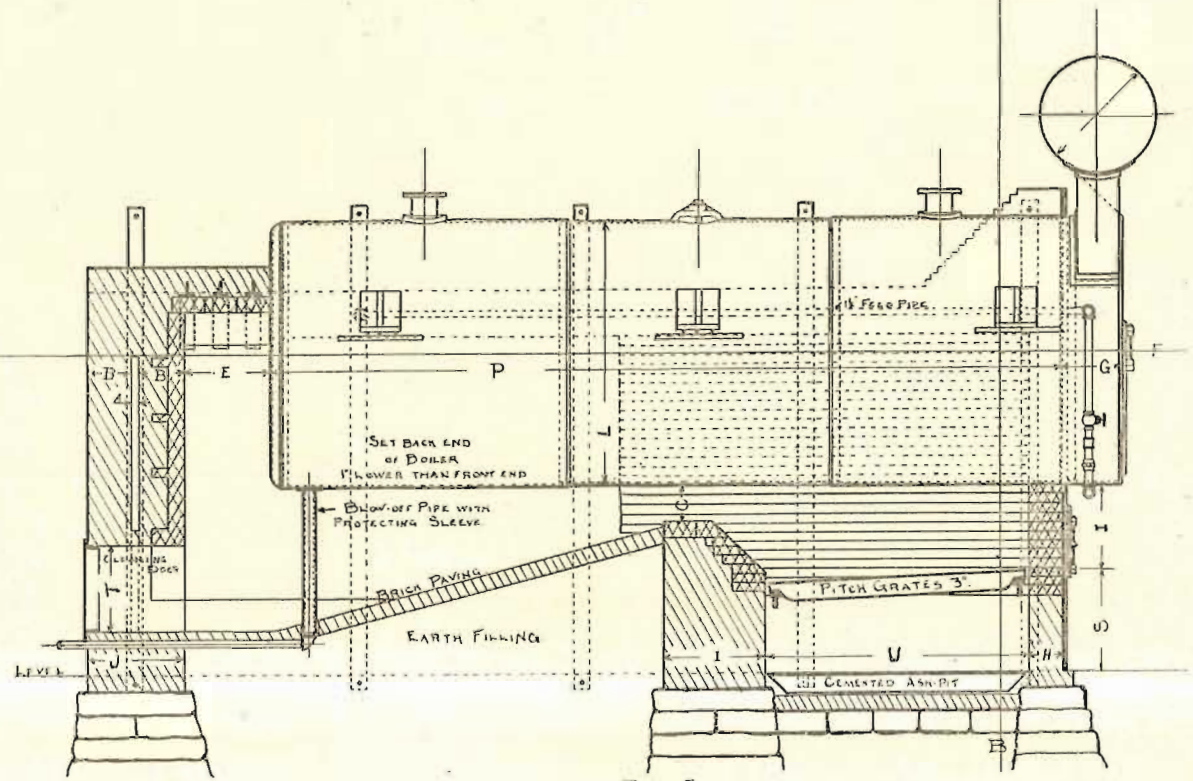

FIG. 3

LONGITUDINAL SECTION OF WALLS AT 'C-D' FIGS 1 & 2.

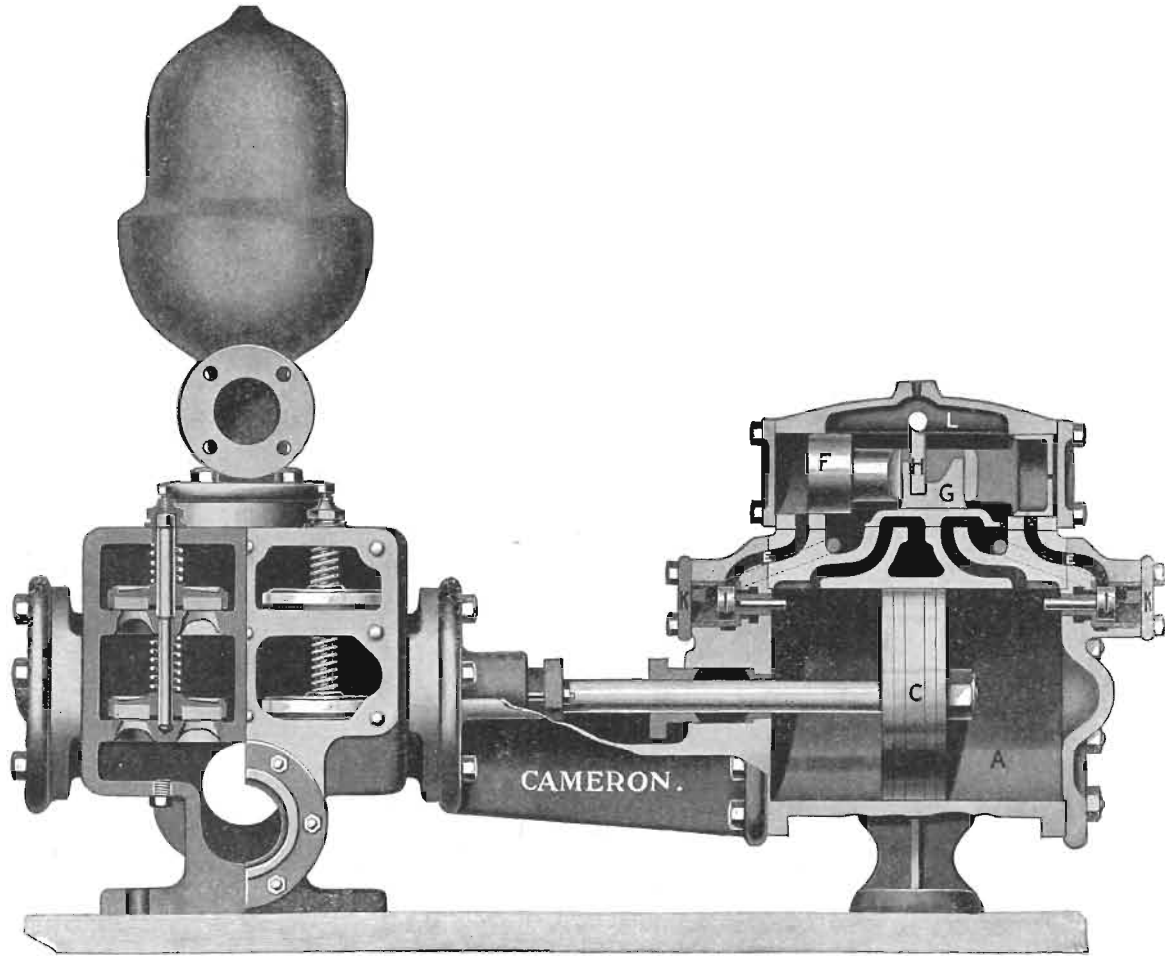

PLATE XV. Type of boiler feed-pump; simple, direct acting, in section.

The cost of a heater and purifier is insignificant compared with the saving effected by its installation and use.

When waste heat is applied to the feed-water the saving which may be effected is given by the following table:

TABLE 3—PERCENTAGE OF FUEL SAVED BY HEATING FEED-WATER.
(Steam Pressure, 80 pounds.)

| INITIAL TEMPERATURE OF WATER. | TEMPERATURE OF WATER ENTERING BOILER—DEG. F | | | | | | | | |
|-------------------------------------|---|-------|-------|-------|-------|-------|-------|-------|-------|
| | 160° | 180° | 200° | 202° | 204° | 206° | 208° | 210° | 212° |
| 40° | 10.23 | 11.93 | 13.64 | 13.81 | 13.87 | 14.15 | 14.32 | 14.49 | 14.66 |
| 50° | 9.46 | 11.18 | 12.90 | 13.07 | 13.24 | 13.41 | 14.58 | 13.75 | 13.92 |
| 60° | 8.67 | 10.40 | 12.13 | 12.31 | 12.48 | 12.65 | 12.83 | 13.00 | 13.17 |
| 70° | 7.87 | 9.62 | 11.37 | 11.54 | 11.72 | 11.89 | 12.06 | 12.24 | 12.41 |
| 80° | 7.08 | 8.85 | 10.61 | 10.78 | 10.95 | 11.12 | 11.29 | 11.46 | 11.63 |

For additional tables on savings by heating of feed-water see Kent's Hand Book, p. 727, Fifth Edition.

With proper arrangement the average temperature of the feed-water can be kept at 200 degrees F. This means a saving in fuel of 12.9 per cent for cold water averaging 50 degrees F. and steam at 80 pounds per square inch.

There are many forms of exhaust feed-water heaters on the market. They may be classified as open heaters and closed heaters.

Fig. 36 shows in diagram the essential features of the open heater, and Fig. 37 those of the closed heater.

Figs. 38 and 39 show commercial forms, respectively, of the open and closed heaters. Both are of the vertical type, which is more economical of floor space than the horizontal type.

Two principal differences are noted. In the open heater the steam and the feed-water are in contact and the feed-water is not under pressure. In the closed heater the steam and the feed-water are under pressure.

In general there are claimed for the open heater the following principal advantages:

1. The open heater is essentially more efficient than the closed heater, because the steam which furnishes the heat comes into intimate contact with the water to be heated, and the resulting temperature of the latter is higher than can be in the case of the closed heater, wherein all heat transfer must be effected through metal partitions which offer some resistance to such transfer. With water free from scale-forming solids and from grease, this

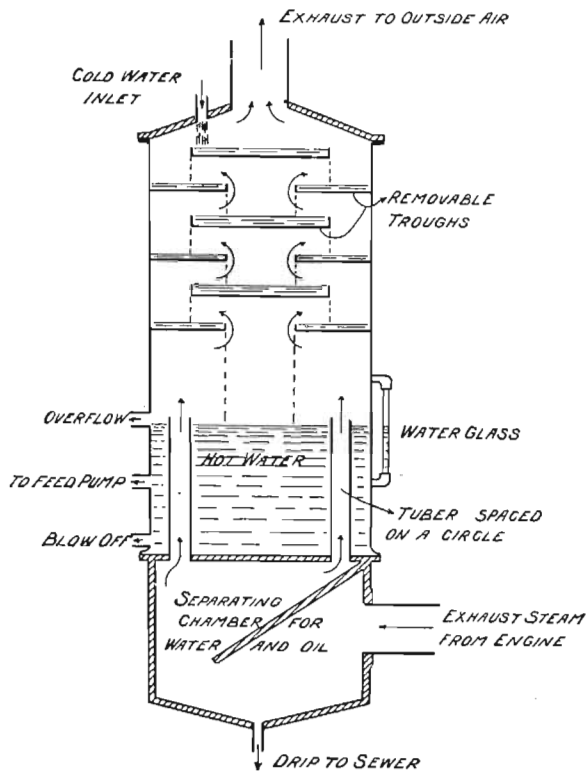

FIG. 5.

FIG. 36. Feed-water heater.

resistance is practically negligible where the metal partitions are of clean copper, but in the majority of cases the feed-water is far from pure and the conductivity of the metal partitions is seriously impaired by scale and grease.

2. The open heater, as usually constructed, (See Fig. 36), is provided with pans, trays or troughs over which the feed-water passes at a low velocity, depositing thereon much of the scale-forming matter; in fact, a portion of the scale is deposited in the heater instead of in the boiler. This partial purification is effected without impairing the efficiency of the heater. In the closed heater the deposition of the scale on the metal partition is objectionable as above stated.

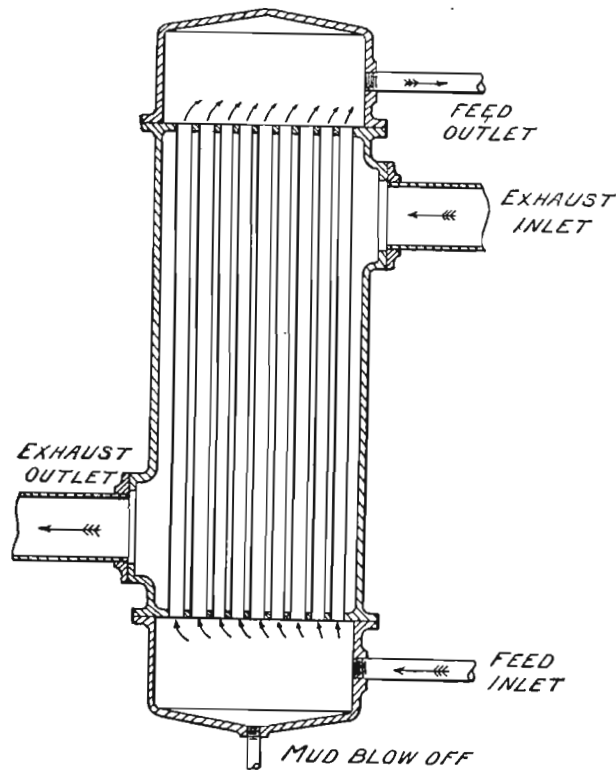

FIG. 6.

FIG. 37. Feed water heater.

3. If, for any reason, the exhaust steam of the main engine is otherwise utilized, the exhaust steam from the feed pump and other auxiliaries can be used in either style of heater. In either case most or all of it will be condensed by the feed-water. In

the open heater this results in a direct saving in the amount of water required for the plant.

4. In the open heater, the air in the free-water is largely liberated by the heat and passes off with the exhaust steam. In general the closed heater should be used if the water is very free

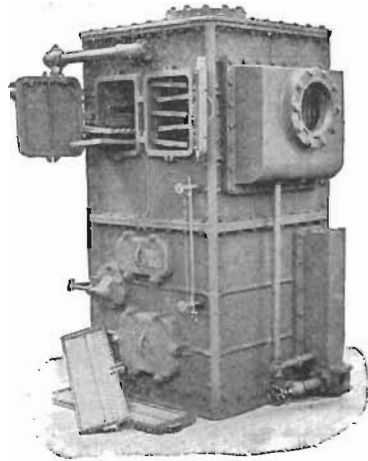

FIG. 38. Type of open feed-water heater.

from mineral impurities or contains only those impurities which will not precipitate at the temperatures attainable with exhaust feed-water heaters.

If the closed heater is used it should be placed in the main exhaust pipe and the feed-water should be handled with an injector arranged to deliver to the boiler through the heater. All things taken into account, the open heater will best meet the needs of the plants under consideration.

In selecting an open heater the following features should be required:

1. A separator, either as an integral part of the heater itself, as indicated in Fig. 40, or as a separate appliance in the main exhaust pipe, or in each of the exhaust pipes of all engines discharging their exhaust through the heater. The former design is preferred.

2. A reservoir or receiver for the heated water, so designed that the water is kept hot until withdrawn by the pump. One

way of constructing such a reservoir is shown in Fig. 40. The exhaust steam passes through a number of tubes surrounded by the feed-water.

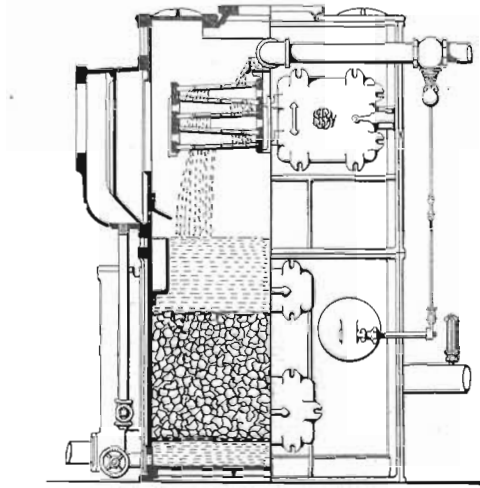

FIG. 39. Sectional view of open feed-water heater.

3. The reservoir should be capacious and provided with blow-off overflow and water glass. The feed pump connection should be a few inches above the blow-off.

4. A large heating and purifying chamber containing pans, trays or troughs arranged so that the cold feed-water shall flow over all of them at the same time so that the exhaust steam shall be compelled to come in contact with the water on every tray.

5. The trays should be readily removable and of such construction that the accumulation of scale thereon can be knocked off or picked off without injury to the trays.

It is a good plan to extract the grease from the exhaust steam used for heating the feed-water, because most cylinder oils are injurious to a boiler when allowed to accumulate therein.

The extraction of the grease can be accomplished by the use of "separators" which are essentially enlargements of the exhaust pipes wherein the steam throws down its entrained water and oil which are led off by a drip-pipe.

FIRING.

A bad fireman is a poor investment, even if he pay for the privilege of firing, and a good fireman is a jewel. In spite of the extensive use of automatic stokers in large plants, it remains a fact that intelligent hand firing is more economical than machine firing for most plants. It is a mistake to suppose because the power station uses but a small portion of the whole coal of the

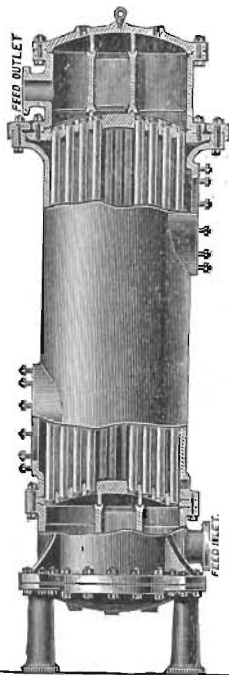

FIG. 40. Type of closed feed water heater.

works, that economy in firing is unimportant. The expense account is made up of a few large items and many small ones. If the small ones are expunged or reduced the credit margin is increased. The secret of good firing is in securing the right amount of air at all points in the fire. The top of the stack is a good indicator of the economy of the fire box, and a window in the roof of the boiler room, with a man under it who will look up, are useful adjustments to any boiler room.

For the proper handling of his fuel the fireman should have knowledge of its properties. For the information of users of Iowa coal the following discussion will be found of value:

Iowa coals are almost entirely bituminous and non-coking. "In nearly all cases ordinary breakage of coal yields more or less of cubical blocks of varying size" which are much broken up by transportation and weathering. The amount of breakage depends also upon whether the "long wall" or "shooting" method of mining is used. In the former the coal is undermined and broken off by settling of the roof or wedged down, and in the latter the coal is removed by drilling and blasting. The latter process

breaks up the coal very thoroughly and is a quicker process, but lessens the value of the product.

An average of 64 analyses by the State Geologist gives the following chemical composition:

| | |
|----------------------|--------|
| *Moisture | 8.57 |
| Fixed carbon..... | 45.42 |
| Volatile matter..... | 39.24 |
| Ash..... | 6.77 |
| | <hr/> |
| | 100.00 |

Analyses of coal from 16 mines in the Des Moines River district gives:

| | |
|-------------------|--------|
| **Moisture..... | 8.08 |
| Fixed carbon..... | 45.60 |
| Volatile | 38.14 |
| Ash..... | 8.18 |
| | <hr/> |
| | 100.00 |
| Sulfur | 3.42 |

or on the basis of oven dried samples,

| | |
|----------------------|--------|
| **Fixed carbon..... | 49.62 |
| Volatile matter..... | 41.49 |
| Ash..... | 8.89 |
| | <hr/> |
| | 100.00 |
| Sulfur | 3.72 |

In 1901-02, at the Iowa State College, Mr. F. M. Weakly made a study of the chemical compositions of Iowa coals, from which the following is quoted:

“The moisture in Iowa coals varies (for the coals tested) from 4.03 to 17.47, the average being 8.08. This moisture is high, as compared with that in coals of other states.

“Eliminating moisture from our comparisons, in volatile matter the Iowa coals are rich, varying from 36.94 to 48.69, with an average of 41.49.

“The fixed carbon ranges from 44.86 to 54.91, with an average of 49.62, slightly lower than that of many coals from other states.

* Steam Boiler Economy, Kent, p. 74.

** F. M. Weakley, The Iowa Engineer, June, 1902.

“Total combustibles are high, running from 84.88 to 95.91, with an average of 91.11.

“Ash is low, being from 4.09 to 15.12, with average of 8.89.

“Sulfur is high, from 2.27 to 7.41, with an average of 3.72.

“The coals high in sulfur are also high in ash.”

Concurrently with the work of Mr. Weakly, Messrs. Austin and Peshak, under the direction of the writer, determined the calorific power of samples of coal from twenty or more mines from the same district, fourteen of the samples being the same as used by Mr. Weakley.

The Parr calorimeter was used. The results are a minimum of 11941, a maximum of 13141 and an average of 12343 B. T. U. per pound of oven dried coal.

The following table exhibits the results of the work of Messrs. Austin and Peshak:

| CALORIFIC POWER OF IOWA COALS AND OTHER FUELS. | | B T U. |
|---|--|--------|
| Slack coal, Marquisville, Iowa | | 10574 |
| Spring Valley, Ill. | | 12608 |
| West Virginia screenings | | 11331 |
| Lumsden Coal and Mining Company | | 12097 |
| Des Moines Coal and Mining Company | | 12041 |
| Whitebreast Fuel Company, Hilton, Iowa | | 12396 |
| Whitebreast Fuel Company, Pekay, Iowa..... | | 13050 |
| Hocking Valley Coal Company, Mine No. 1..... | | 12037 |
| Hocking Valley Coal Company, Mine No. 2..... | | 12560 |
| Lumsden Coal Company, Bloomfield, Iowa..... | | 13204 |
| Kalo, Iowa..... | | 10451 |
| Centerville Block Coal Company..... | | 12681 |
| Eldon Coal and Mining Company, Laddsdale | | 13141 |
| Consolidated Coal Company, Buxton, No. 10. | | 12030 |
| Consolidated Coal Company, Buxton, No. 11. | | 10585 |
| Lodwick Brothers Coal Company, Mystic. | | 12780 |
| Carbon Coal Company, Willard..... | | 12245 |
| Crowe Coal Mining Company, Boone | | 12729 |
| Corey Coal Company, Lehigh..... | | 12431 |
| Platt Pressed and Fire Brick Company, Van Meter | | 11941 |
| Jasper County Coal and Mining Company, Colfax..... | | 12134 |
| Empire Coal Company | | 10881 |
| A. A. Conway Coal Company | | 10132 |
| Anthracite coal | | 12532 |
| Crude petroleum Beaumont, Texas | | 19000 |
| Crude petroleum, Chanute, Kansas..... | | 19488 |
| Lamp black..... | | 14467 |

In 1900 boiler tests at the Iowa State College gave the results exhibited in Table No. 4.

TABLE No. 4.

| KIND OF FUEL. | Cost per Ton of 2,000 lbs. | Fuel Cost of 1,000 lbs. Steam from and at 212°. |
|----------------------------|-------------------------------|--|
| Marquisville slack..... | \$1.43 | 14.9 cents |
| Marquisville steam..... | 2.35 | 21.2 cents |
| Marquisville nut..... | 2.54 | 21.5 cents |
| Marquisville lump..... | 2.28 | 24.0 cents |
| Coke, eastern foundry..... | 8.00 | 60.4 cents |
| Anthracite nut..... | 8.95 | 52.8 cents |

The interesting feature of these results are the prohibitive cost of anthracite and coke and the advantage of slack over the better grades of coal from the same mine.

It is evident that transportation charges will materially change the relative values of coal for steam generation. It is also true that the method of handling, the design of the boiler setting and the character of the fuel itself as to ash, sulfur and moisture will materially influence the cost of generating a unit quantity of steam.

Methods of Firing.—Frequent and small charges of fuel intelligently distributed will enable the burning of the poorest fuel with a minimum of smoke and a maximum of economy even in furnaces which are not ideal in their construction. Slack and steam coal should be fired in thin beds, three to six inches, and lump coal ten to twelve inches, and the fires should not be disturbed too often by shaking or poking.

Wetting the fuel before firing is sometimes useful in promoting coking and preventing the carrying off through the chimney of small particles of unburned coal.

Flues should be frequently cleaned by scraping or blowing with steam or air. A steam jet over the fire is useful when the coal is freshly fired, but is detrimental at other times.

If used continuously the loss of heat in the steam is appreciable, and being useless, is inexcusable.

The ideal conditions for combustion exist when the air supply is from one and one-half to two times the theoretical amount and when the same is thoroughly mixed with the combustible portion of the fuel at a temperature equal to or greater than the temperature of ignition. These conditions can be very nearly attained for Iowa coal if the principles of the boiler and the furnace design and operation above enumerated are followed.

ENGINES.

The selection of an engine is not governed by rules so much as by the individual judgment of the purchaser. Consequently, engines vary more in detail than boilers of the type above discussed.

The writer is of the opinion that up to 100 horse power the moderate speed throttling or automatic engine will best meet the needs of clay workers, and for large powers the Corliss engine may be used to advantage. For either type the following general proportions should be observed:

Diameter of steam pipe equal to one-third cylinder diameter.

Diameter of exhaust pipe equal to one-half cylinder diameter.

Diameter of piston rod equal to one-sixth cylinder diameter.

Diameter of shaft equal to one-half cylinder diameter.

Diameter of crank pin equal to one-third to one-half cylinder diameter.

Length of connecting rod equal to three times length of stroke.

The effective power of a single high or medium speed engine can be calculated by use of the formula:

Horse power = $0.002 \times L \times A \times N$ wherein

L = length of stroke in feet.

A = area of piston in square inches.

N = number of revolutions per minute.

For a simple Corliss engine the corresponding formula is

Horse power = $0.0018 \times L \times A \times N$.

Both engines are supposed to use steam at 80 pounds, boiler pressure. Increase in boiler pressure will give a proportionate increase in capacity of engine in either case.

In addition, it should be remembered that durability is proportional to weight, and that weight is cheap in first cost, that convenience in adjustment, simplicity of detail and perfect lubricating devices are essential.

Engine foundations should be massive and well built. They should rest on hard and natural soil or rock, and the engine should be securely bolted thereto.

MINOR ITEMS.

All live steam pipes and fittings and the tops of boilers should be thoroughly lagged with sectional non-conducting covering or its equivalent. Such covering, if of good quality, will last ten or fifteen years and will pay for itself in three years in heat saved that would otherwise be lost by radiation. It is important that the pipe covering should be applied with care in order to have the pipe completely covered, by the covering, and not merely by the canvass wrapper. The latter should be thoroughly pasted down and the metal bands tightened.

Self-oiling bearings or other continuous oiling devices and an oil filter will save their cost in a year and will last many years.

When properly cared for, the leather belt is the most satisfactory in the long run, but the writer believes that rope transmission will be found to be adapted to clay work, by the reason of its flexibility and its ability to endure exposure.

Narrow double belts are better than wide single belts of the same weight.

A belt speed of 3,000 feet per minute gives good results. At this speed a double belt, glued joints, one inch wide, will transmit easily four to five horse power if the pull is steady and not jerky.

A rope can be safely run at 4,500 feet per minute, and a one-inch rope at this speed will transmit from a single groove pulley not less than 13 horse power.

In order to heat the drying rooms successfully and economically, the exhaust steam from the engine should be utilized.

At the same time the back pressure on the engine should be kept low. This can be accomplished and at the same time a good circulation of the steam in the coils obtained, if the coils are built as manifold or heater coils, but not if the return bend coils are used. The latter offer too much resistance to the flow of the steam. The heating main, or exhaust pipe continued, should be carried up to and along the ceiling of the drying room and hung with a pitch downward away from the engine. The furthest point of the main should be connected by a large drip to the return main, which should be two-thirds the diameter of the steam main and should pitch downward toward the hot well or heater in the boiler room.

The supply of pipes for the several coils should be taken from the top of the steam main and should pitch downward toward the coils which connect them with the return main. The point of discharge of the return main into the hot well or heater should be the lowest point on the system, so as to insure a "dry" return, and a trap should be provided at this point to prevent the steam from blowing through. The main exhaust of the engine should be provided with a back pressure or relief valve set to work at a lower pressure than the trap, and a grease extractor should be placed in the heating main to keep oil from being carried through the system to the hot well. The construction here outlined will secure, in addition to its main object, the incidental and important advantage of a supply of condensed steam from the boiler feed, and this at a temperature such that the waste steam from the pumps will be able to raise the temperature of the feed well

towards the atmospheric boiling point by means of the heater and purifier above mentioned.

Ventilation is essential and can be secured by stacks or fans, or both. Generally speaking, a fan is a more economical method of moving air than is a column of hot air, and is more easily controlled, but the stack is simpler and therefore frequently more desirable.

THE GEOLOGY OF CLAYS

BY

S. W. BEYER AND I. A. WILLIAMS.

THE GEOLOGY OF CLAYS

BY S. W. BEYER AND I. A. WILLIAMS.

CONTENTS.

| | Page |
|---|------|
| Geological distribution of clays and shales | 381 |
| Saint Croix sandstone | 382 |
| Oneota limestone | 382 |
| Saint Peter sandstone | 383 |
| Galena-Trenton | 383 |
| Allamakee county | 383 |
| Maquoketa shales | 384 |
| Clayton county | 385 |
| Clinton county | 387 |
| Delaware county | 388 |
| Dubuque county | 390 |
| Fayette county | 393 |
| Winneshiek county | 394 |
| Silurian | 395 |
| Devonian | 395 |
| Cerro Gordo county | 396 |
| Floyd county | 400 |
| Franklin county | 402 |
| Carboniferous | 402 |
| The Lower Carboniferous | 403 |
| Kindernook | 403 |
| Des Moines county | 403 |
| Lee county | 407 |
| Washington county | 408 |
| Augusta | 409 |
| Saint Louis | 410 |
| The Upper Carboniferous | 410 |
| The Coal Measures | 410 |
| Adair county | 415 |
| Adams county | 415 |
| Appanoose county | 415 |
| Boone county | 419 |

| | Page |
|------------------------------|------|
| Dallas county | 424 |
| Decatur county | 429 |
| Des Moines county | 430 |
| Fremont county | 432 |
| Greene county | 432 |
| Guthrie county | 433 |
| Hamilton county | 435 |
| Hardin county | 436 |
| Humboldt county | 440 |
| Jasper county | 440 |
| Jefferson county | 441 |
| Keokuk county | 444 |
| Lee county | 446 |
| Lucas county | 447 |
| Madison county | 447 |
| Mahaska county .. | 450 |
| Marion county | 452 |
| Monroe county | 454 |
| Montgomery county | 457 |
| Muscatine county | 459 |
| Page county | 461 |
| Polk county | 463 |
| Poweshiek county | 477 |
| Scott county | 479 |
| Story county | 481 |
| Taylor county | 482 |
| Union county | 483 |
| Van Buren county | 483 |
| Wapello county | 484 |
| Warren county | 490 |
| Wayne county | 494 |
| Webster county | 494 |
| The Cretaceous | 509 |
| Calhoun county | 509 |
| Montgomery county | 511 |
| Plymouth county | 512 |
| Pottawattamie county | 513 |
| Sac county | 514 |
| Sioux county | 514 |
| Woodbury county | 515 |
| The Pleistocene | 525 |
| Pre-Kansan or Albertan | 526 |
| Kansan | 526 |
| Illinoian | 528 |
| Iowan | 528 |
| Delaware county | 529 |
| The loess | 529 |
| The red clay | 532 |

| | Page |
|--------------------------|------|
| The gumbo | 534 |
| Burnt clay ballast | 534 |
| Iowan loess..... | 538 |
| Wisconsin..... | 547 |
| Buena Vista county | 548 |
| Clay county..... | 549 |
| Pocahontas county | 550 |
| Post-Wisconsin..... | 552 |

CHAPTER VII.

Geological Distribution of Clays and Shales.

With the exception of the Sioux quartzite, which presents limited exposures in the northwest corner of the state, every great rock formation exposed in the state contains more or less important argillaceous deposits. Such deposits range in character structurally from the highly fissile shales of the Lower Silurian and certain bituminous members of the Coal Measures to the structureless deposits of loess; in composition, all gradations may be observed from the purest fire clays to the most impure alluvial and drift deposits. The range in plasticity is equally great from the highly plastic potter's clays to the arenaceous shales and sandy surface clays. They not only show great diversity when the members of the different formations are compared, but the shales of the same formation are widely different and require different treatment, a fact which is not always appreciated in the clay industries. In the following pages the shale and clay members of the various formations are treated in chronological order. No attempt is made to describe or even enumerate all of the exposures for any rock series. Attention is directed rather to those exposures which are considered to be the most accessible and at the same time representative. But little space is devoted to the description of clay plants, only as such description throws light on the workability of the materials. Especial stress is laid

on the chemical and physical properties of the raw materials which would commend them to, or cause their rejection by, the clay worker. Workability and availability of the deposits are given the attention their importance merits.

THE SAINT CROIX SANDSTONE.

The Saint Croix Sandstone.—The Saint Croix comprises an essentially non-argillaceous rock series so far as its outcrops in Iowa are concerned. Minnesota geologists separate it into three divisions: the Basal sandstone, the Saint Lawrence shales and the Jordan sandstone in the sequence from the base upwards. As the names imply, the lowest and the uppermost members are almost exclusively sandstone, while the middle member is composed of shales, marls and limestones. The two upper members only appear on the surface in Iowa, and their outcrops are confined to Allamakee and Clayton counties. Their combined thickness, according to Norton, is about 300 feet. Calvin, in his report on the geology of Allamakee County, states that a bed of light colored shale is exposed in the road cutting near the northeast corner of the upland portion of the county, about two miles from New Albia. The shale lies about 200 feet below the summit of the Saint Croix and doubtless may be referred to the Saint Lawrence beds. No attempt has been made, so far as known, to utilize the shale commercially. The general dip to the south and west carries the beds below the stream, and no further exposures are known.

ONEOTA LIMESTONE.

The Oneota limestone extends from Winneshiek through Allamakee into Clayton county. The formation consists largely of the massive dolomite divided by a medial sandstone supposed to be the equivalent of the New Richmond of the Minnesota and Wisconsin geologists. The upper dolomite member often becomes

argillaceous near its summit. Such shale layers are reported by Professor Calvin in his Allamakee County report, but the beds lack persistence and are not of sufficient thickness to warrant their development on a commercial scale.

SAINT PETER SANDSTONE.

As the name implies, the Saint Peter is constituted almost wholly of a clean, well weather-worn, white sand but slightly indurated. The outcrops of the Saint Peter are confined to Winneshiek, Allamakee and Clayton counties. While certain beds of passage from the Saint Peter to the Trenton limestone become more or less argillaceous in character, no shales or clays appear in the surface exposures.

THE GALENA-TRENTON.

The Galena-Trenton comprises the lower limestone series often grading downward into a fissile blue or green shale with intercalated shales of less importance throughout; and an upper massive dolomitic member often designated the Galena-Trenton because it contains most of the workable lead deposits of the Iowa-Illinois-Wisconsin area. The Galena-Trenton extends from Howard to Dubuque and Jackson counties and comprises considerable areas in Winneshiek, Allamakee and Clayton counties. The principal outcrops are confined to the Mississippi, Upper Iowa, Yellow and Turkey rivers and their immediate tributaries.

Allamakee County.—In Allamakee county the shale at the base of the Trenton averages five to six feet in thickness and is generally overlain by rather massive beds, "The Lower Buff Beds." The same may be seen at numerous points in the exceedingly sinuous line that marks the contact of the Saint Peter sandstone with the Trenton. It is well exposed on the road leading north of Waukon, on both sides of Village creek. In the valley of Paint creek, about two miles below Waukon, it appears at the surface.

The best example for pottery purposes appears in the valley of a tributary of Silver creek in Makee township. The Trenton contains other shaly layers which are generally unimportant, commercially, on account of their thinness or lack of persistency. The most important of all these begins about forty feet above the base of the shales and continues upward some thirty feet. It is often inter-stratified with thin limestone seams which are highly fossiliferous. The shale itself may be rendered useless for brick purposes on account of the fossils and calcareous concretions it contains. The third shale horizon occurs near the top of the Trenton and is perhaps the most important economically, as it attains the thickness of ten to twenty feet in some instances. Exposures may be viewed about two miles north of Postville and at the same geological level in the hillside south of the Yellow river. This seam is not worked in Allamakee county. While outcrops of the Trenton shales are more or less common in the counties in which the lower Galena-Trenton rocks are exposed, they have not, as yet, been utilized in the manufacture of clay goods.

THE MAQUOKETA SHALES.

The Maquoketa comprises a series of beds, mainly shales varying much in color, composition and texture, and attaining a maximum thickness, according to Calvin, of 200 feet. The lower Maquoketa is made up of lean fissile shales, with some earthy, non-laminated beds carrying fossils. The upper Maquoketa consists of plastic clay shales, carrying occasional indurated, fossiliferous bands near the top and passing into thin layers of impure, earthy dolomite, "transition beds", to the Niagara limestone. The area of outcrop of the Maquoketa shales forms a narrow but extremely sinuous zone from Jackson county, on the south, through Dubuque, Delaware, Clayton, Fayette, Winneshiek and Howard counties, to the north. The most important expos-

ures may be viewed in Dubuque, Clayton and Fayette counties.

Clayton County.—The Maquoketa shales are well exposed a mile and one-half northeast of Elgin, on the northwest quarter of section 18, in Marion township. About ten feet of blue shales are exposed here in a ravine, and are overlain by about thirty feet of dolomite. In the southern portion of the county they form the valley bottoms, and the Maquoketa shale may be seen outcropping in what is known as "Newberry Park," one mile and a half northeast of Strawberry Point, and also in "Bixby's Park,"

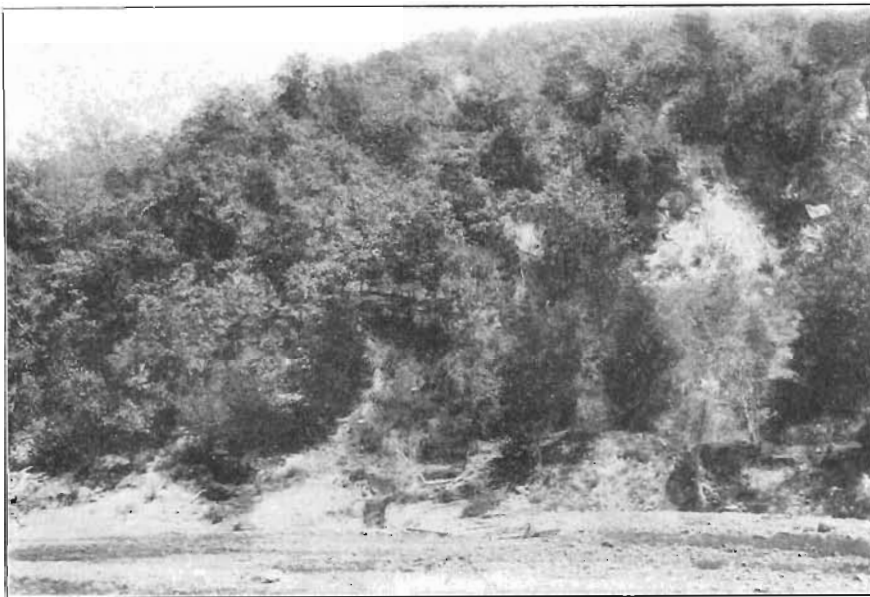

FIG. 41. Section near Edgewood showing over sixty feet of Maquoketa shales.

one mile and a half north of Edgewood. At both of these points the shale is gray-blue and fairly plastic. On the northeast quarter of section 33, in Sperry township, seventy feet of blue shale are exposed along one of the tributaries of Hewett creek. The shale outcrop lies from forty to fifty feet below the Niagara limestone. The upper ten feet of the Maquoketa contains calcareous

beds, highly fossiliferous but below, fifty or sixty feet of almost pure shale occurs. An analysis gave the following results.

| | |
|--|-------|
| Silica | 52.29 |
| Alumina | 20.64 |
| Combined water..... | 5.17 |
| | <hr/> |
| Clay and sand..... | 78.10 |
| Iron oxide | 5.16 |
| Lime | 1.89 |
| Magnesia | 1.12 |
| Potash | 2.77 |
| Soda..... | 8.27 |
| | <hr/> |
| Total fluxes..... | 19.21 |
| Moisture, sulfur trioxide and carbon dioxide | 2.76 |

RATIONAL ANALYSIS.

| | |
|---------------------|--------|
| Clay substance..... | 70.65 |
| Feldspar | 2.57 |
| Quartz. | 26.78 |
| | <hr/> |
| | 100.00 |

The analysis shows a clay excellently adapted to the manufacture of all of the common clay wares, but when taken in connection with its physical properties, it is especially suited to the manufacture of hollow ware.

The Maquoketa shales which outcrop along Bear creek and its tributaries near Edgewood have been utilized to a limited extent in the manufacture of common brick and tile. The shale becomes very plastic when weathered and is mixed with from two to three times its bulk of loess. As a rule, the shale crops are quite fully concealed by talus and the Niagara limestone. The top of the shale is some 200 feet lower than the town of Edgewood. Some of the exposures show the presence of from fifty to sixty feet of workable shale.

A chemical analysis shows the presence of more of the lime and magnesium carbonate and less sodium and aluminum than in

the sample from Newberry Park. The composition was found to be as follows:

| | |
|---------------------|-------|
| Silica | 44.39 |
| Alumina..... | 13.72 |
| Combined water..... | 12.18 |
| | <hr/> |
| Clay and sand..... | 70.29 |
| Iron oxide | 7.80 |
| Lime..... | 7.88 |
| Magnesia..... | 6.05 |
| Potash..... | 1.56 |
| Soda..... | 5.29 |
| | <hr/> |
| Total fluxes..... | 28.58 |
| Moisture..... | 0.89 |

RATIONAL ANALYSIS.

| | |
|-----------------------------------|--------|
| Clay substance..... | 40.61 |
| Feldspar..... | 4.62 |
| Quartz..... | 28.00 |
| Lime and magnesium carbonate..... | 26.77 |
| | <hr/> |
| | 100.00 |

Notwithstanding the high percentages of lime and magnesium carbonates present, the ware when properly burned is strong and gives good service.

While the Maquoketa occurs in Winneshiek and Howard counties, it thins materially and carries an increased percentage of the carbonates and has not been utilized economically.

Clinton County.—The Maquoketa shales show numerous exposures in the northeastern corner of the county. One of the best of these is at the northern limit of Lyons, in the bluffs just to the west of the railroad tracks. The Niagara produces a perpendicular escarpment, perhaps fifty feet in height, and contains chert bands. Within six feet of its base the Maquoketa appears nine feet above the track, at the northern end of the bluff, and has been dug out for several feet below the track. The exposure is perhaps sixty feet long, and the pitch is approximately one foot

in thirty. A short distance south of this point the Niagara extends to the water level in the river. From Lyons northward to the northeast corner of Clinton county, the shales are partly exposed at intervals in the bluffs along the river. At Elk River Junction there are a number of incomplete outcrops well up the slope. The shale exposed at Lyons is blue in color and quite hard when unweathered. It slakes rather readily, and on exposure to the action of the weather becomes quite plastic. The clay is highly refractory and ought to make a good quality of the ordinary wares. In the manufacture of common brick and drain tile a blend composed of the Maquoketa shale and the loess might be used advantageously. Some attempts have been made to use the shales, but without satisfactory results.

Delaware County.—Exposures of the Maquoketa shales are confined to the extreme northeast corner of the county, along Little Turkey river and Elk creek, one of its tributaries. No satisfactory sections are available because of the heavy Niagara talus. The beds above the shale exposed at what is known as “Big Spring,” in the southeast quarter of the northeast quarter of section 3, in Colony township, are as follows:

| | FEET. |
|---|-------|
| 5. Steep slopes, sodded over | |
| 4. Niagara limestone in thick, heavy ledges | 10 |
| 3. Transition beds; soft, yellowish, argillaceous limestone, more shaly below, and becoming more calcareous above, in thin layers | 25 |
| 2. Hardened shale in two to four-inch layers. | 1 |
| 1. Bluish shale, indurated, composed of thin laminae and non-fossiliferous. | 4 |

The spring issues on top of the shale and is 230 feet lower than the level of the plateau upon which Colesburg is built. One-fourth mile below the spring there is a clay pit from which the Colesburg Pottery Company obtain their clay. The pit is sixty feet lower than the spring, and there is an almost continuous section of shales between.

A chemical analysis of the Colesburg shales gives the following results:

| | |
|---------------------|-------|
| Silica | 43.62 |
| Alumina | 24.40 |
| Combined water..... | 12.41 |
| | <hr/> |
| Clay and sand..... | 80.43 |
| Iron oxide..... | 2.00 |
| Lime | 3.39 |
| Magnesia | 0.18 |
| Potash..... | 4.17 |
| Soda..... | 6.19 |
| | <hr/> |
| Total fluxes..... | 15.93 |
| Moisture | 3.85 |

RATIONAL ANALYSIS.

| | |
|---------------------|--------|
| Clay substance..... | 83.57 |
| Feldspar | 7.60 |
| Quartz | 8.83 |
| | <hr/> |
| | 100.00 |

The Colesburg pottery uses a fissile gray-blue shale, which slakes readily and becomes fairly plastic. When exposed, it weathers rapidly to a yellowish-blue plastic clay. At present the company manufactures only flower pots and plain red earthenware.

On account of the relatively low percentage of silica and high percentage of strong fluxes, the clay burns at a low temperature, and this fact, taken in connection with its plasticity, makes it eminently fitted for the manufacture of hollow building block and drain tile, uses to which it has never been put.

The clay is broken down and permitted to weather through the summer months and hauled during the winter and dumped on the ground outside of the factory building. It is prepared for use by being placed in a tank and permitted to soak two or three days. The soaked clay is shoveled into a vertical pug mill, the counter-

part of the soft mud mill, except this machine is driven by gearing at the top. The clay is tempered to a rather softly plastic condition and then passed through a pair of small rolls. Just before passing through the mill, one-fourth of redder brown top clay is added which is said to make the body work better. Pots ranging from one and three-fourths to seven inches in diameter are made in a flower pot machine. The machine consists of a lower rapidly revolving horizontal platform in the center of which is a depression the size of the pot to be made. In this depression a plunger works up and down, up when ready to receive the clay. After the clay passes the rolls, it is fed into a small horizontal plunger machine with two dies. As the clay issues from this tube it is cut off by wires stretched in a wooden frame into definite lengths for the size of pot desired. The plunger is actuated by a piston from the engine. The largest pots are made in a potter's jigger or jolly, in molds, the clay being taken directly from the rolls. The ware is dried on two floors, the upper of which is slatted, and burned in a small up draft kiln. The finished product is shipped largely to Dubuque, and finds a ready market.

Other exposures occur along the stream-ways in the vicinity of the pit of the Colesburg pottery, but none have been developed. Well sections demonstrate the general distribution of the shale and indicate that it attains a thickness of ninety feet.

Dubuque County.—Professor Calvin, in his report of the geology of Dubuque county, separates the Maquoketa into two well-defined parts; the upper series of plastic clay shales with some indurated fossiliferous bands near the top grading through transitional beds composed of thin layers of impure earthy dolomite into the Niagara dolomite above; the lower beds comprised of lean, fissile shales with some earthy non-laminated beds carrying *Orthoceras* and other fossils. The upper beds weather more easily than the lower, readily breaking down into highly plastic

clay, and yields readily to the clay-worker's art. The Maquoketa comprises the most irregular area in the northeast portion of the county, while a small area exists in the extreme northwestern corner. From fifty feet to more than one hundred feet of fairly plastic clay shales are available, but are not readily accessible save at a few points—at Kidder and Graf, on the Great Western



FIG. 42. Maquoketa shales west of Graf.

Railway, and at Peosta, on the Illinois Central Railway. Usually the shales are overlain by the Niagara limestone whose heavy talus would render the development of the shales commercially unprofitable. About one-half mile west of Graf the following beds may be observed in the railway cut:

| | FEET. | INCHES. |
|--|-------|---------|
| 5. Shale, drab and black, unfossiliferous..... | 2 | |
| 4. Shale, brownish, hard, granular, non-fissile and fossiliferous | 1 | 2 |
| 3. Shale, drab, fissile, non-fossiliferous | 1 | 4 |
| 2. Shale, variable in color, texture, and fissility; numerous fossiliferous bands | 11 | |
| 1. Shale, brown or black, non-fissile; fossils rare.... | 6 | |

The highly fossiliferous layers are usually more or less calcareous or dolomitic, and, as a consequence, unsuited for the manufacture of clay wares.

The analysis of shales developed near Kidder gives the following results:

| | |
|---------------------|-------|
| Silica..... | 42.53 |
| Alumina..... | 16.83 |
| Combined water..... | 15.76 |
| | <hr/> |
| Clay and sand..... | 75.12 |
| Iron oxide..... | 5.66 |
| Lime..... | 5.66 |
| Magnesia..... | 4.82 |
| Potash..... | 3.70 |
| Soda..... | 4.10 |
| | <hr/> |
| Total fluxes..... | 23.94 |

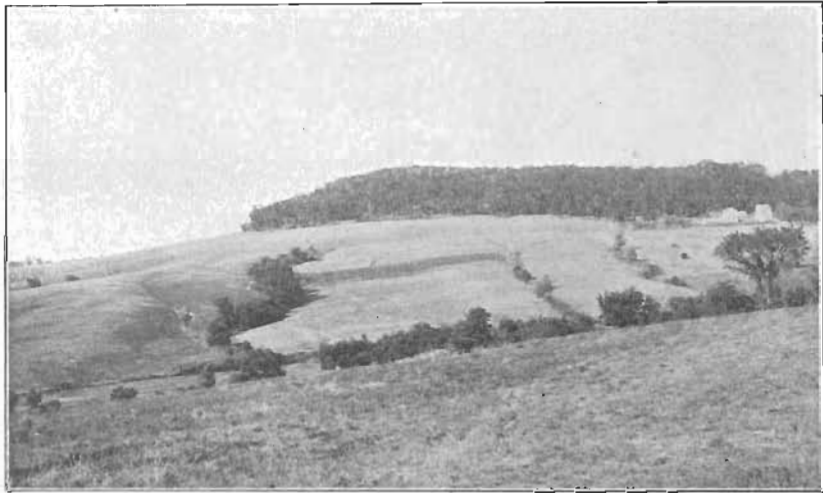

FIG. 43. Characteristic topography of the Maquoketa shales near Graf.

The clay has been tested at Bucyrus, Ohio, and when repressed makes a smooth, cherry red brick of excellent strength and appearance. The clay is also suited for pottery, but would not prove satisfactory for pavers, on account of the percentage of fluxes present.

Fayette County.—Near the town of Clermont, the Clermont Brick & Tile Company have been developing shale beds near the top of the bluff northeast of the railway station and overlooking the town. These beds were formerly supposed to belong to the Trenton series, but recently have been demonstrated by Professor Calvin to contain a Maquoketa fauna. The section is as follows:

| | FEET. |
|---|--------|
| 3. Surface materials, "geest," of varying thickness. | 0 to 5 |
| 2. Dolomitic limestone, rubbly above and heavy ledges below, cherty throughout, the lower layers become slightly arenaceous to shaly at the surface | 15 |
| 1. Shale, light-gray to blue-gray above, deeper blue below. Where much weathered becoming a plastic clay but when fresh shows fair fissility, exposed | 20 |

The base of the section is more than one hundred feet above the terrace upon which the town is built.

The new pit is along a ravine where the limestone has been removed by erosion, and a thin veneer of highly oxidized surface materials, the "geest," rests directly on the shales and is used to a considerable extent in the process of manufacture to give color to the ware, because of the high percentage of iron it contains. The shale burns almost white when used alone, and shows but little shrinkage. Both rational and ultimate chemical analyses were made, with the following results:

| | |
|-----------------------|-------|
| Silica | 28.82 |
| Alumina | 10.37 |
| Combined water | 16.24 |
| | 55.43 |
| Clay and sand | 55.43 |
| Iron oxide | 3.76 |
| Lime | 19.14 |
| Magnesia | 5.40 |
| Potash | 5.38 |
| Soda | 7.41 |
| | 41.09 |
| Total fluxes | 41.09 |
| Moisture | 0.43 |
| Sulfur trioxide | 3.01 |

RATIONAL ANALYSIS.

| | |
|---------------------|--------|
| Clay substance..... | 73 32 |
| Feldspar | 4 93 |
| Quartz | 21.76 |
| | <hr/> |
| Total | 100.00 |

The analyses show a remarkably high percentage of the alkalis and alkaline earths and consequently a low percentage of silica and alumina.

Winneshiek County.—Frequent outcrops of the Maquoketa shales are known to occur in the southeastern one-third of the county. One of the most important sections may be observed in the vicinity of Fort Atkinson, on the southwest quarter of the west half of section 18, in township 96 north, range 9 west. A tough blue shale is exposed in the bed, and on the bank of a small tributary of Turkey river. The shale rises eight feet above the water and is known to continue below the stream bed. Occasional pyritic concretions and one or two thin seams of hard rock are the only impurities. The shale is but slightly siliceous, slakes slowly and is suitable for the common grades of brick and hollow ware. The exposure is about three-fourths of a mile from the Chicago, Milwaukee & St. Paul railway. Shales very similar to the above are shown in the southwest quarter of section 13. The principal outcrops are about two hundred yards away from the railroad. The surface features indicate that the shales are quite extensive horizontally and lie some twenty feet above the branch. In this vicinity a finely siliceous clay may be observed which has been tested and found to be a good polishing material. The clays in sections 18 and 13 were tested by Mr. F. R. Goddard with satisfactory results. In addition to the localities mentioned, the Maquoketa shales appear at various other points in this portion of the county. They may be observed just beneath the Niagara at a point considerably above the level of Turkey river, about one mile northeast of Fort Atkinson. They also appear directly

under the soil about one and one-half miles south of Calmar, and at intervals along Turkey river as far north as Spillville. As yet they are not being developed.

The Silurian.

Indurated rocks referable to the Silurian cover the larger portions of Fayette, Delaware, Dubuque, Jones, Jackson, Cedar, Clinton and Scott counties. Lesser areas may be found in Winneshiek, Clayton, Buchanan, Linn, Johnson and Muscatine counties. The rocks representing the Silurian system are prevailingly dolomites. While certain of the beds near the base of the series display some tendency to split into thin layers, no clay shales or shales occur in this system. Instead of supporting clay industries, the Silurian dolomites furnished more than four-fifths of the lime and one-half of the building stones produced in the state.

Devonian.

The Devonian period was inaugurated and closed by conditions favorable to the deposition of clays and shales. The lower argillaceous beds in the Devonian are known as the Independence shales and are referred to the Wapsipinicon stage. These shales show limited outcrops in Cedar, Linn and Buchanan counties, near the contact with the Silurian. The shales attain a thickness of twenty feet, are dark colored, often alternating with thin layers of limestone. Occasionally the shales are highly carbonaceous and contain plant remains, some of which have been transformed into true coal. The beds are of no economic importance on account of their varying character and inaccessibility.

The upper shaly member is of much greater importance and belongs to the Lime Creek stage. The Lime Creek shales are typically developed along Lime creek, in Cerro Gordo and Floyd

counties. Important exposures appear at Rockford and Mason City, and at numerous points between. The beds are being commercially exploited at both points.

Cerro Gordo County.—At Hackberry Grove, on the northwest quarter of section 35, in Portland township, the following section may be viewed.

| | FEET. |
|---|-------|
| 4. Brown, yellowish-brown and gray limestone in several layers, fossiliferous, fossils similar to those contained in underlying shale | 4 |
| 3. Shales, yellowish, very calcareous with bands of shaly limestone, weathering partly into clay and partly into small chips or nodules, very rich in beautifully preserved fossils | 20 |
| 2. Shales, yellowish, argillaceous, weathering as does the blue clay below and free from fossils..... | 10 |
| 1. Shales, bluish, argillaceous, weathering into a smooth, plastic clay, unfossiliferous..... | 40 |

The Lime Creek shales are most vigorously exploited at Mason City. The pit of the Mason City Brick and Tile Company shows the following sequence:

| | FEET. |
|---|--------|
| 4. Drift (lowan)..... | 0 to 2 |
| 3. Shale, non-fissile, arenaceous and stained a dark yellow. An indurated ledge of dolomite occurs in places..... | 2 |
| 2. Shale, clayey, yellow, often deeply stained along the joints | 10 |
| 1. Shale, blue, exposed..... | 12 |

Numbers 1 and 2 are gypsecus, small crystals occurring in tabular form or in *rosettes*, along the joints. Both beds are extremely plastic and remarkably well adapted for the manufacture of drain tile and hollow building block. The clay burns to a light red color and fuses at a low temperature. An analysis of the blue clay was made with the following results:

| | |
|----------------------|-------|
| Silica | 54 64 |
| Alumina | 14 62 |
| Combined water | 3 74 |
| | 73.00 |
| Clay and sand | 73.00 |

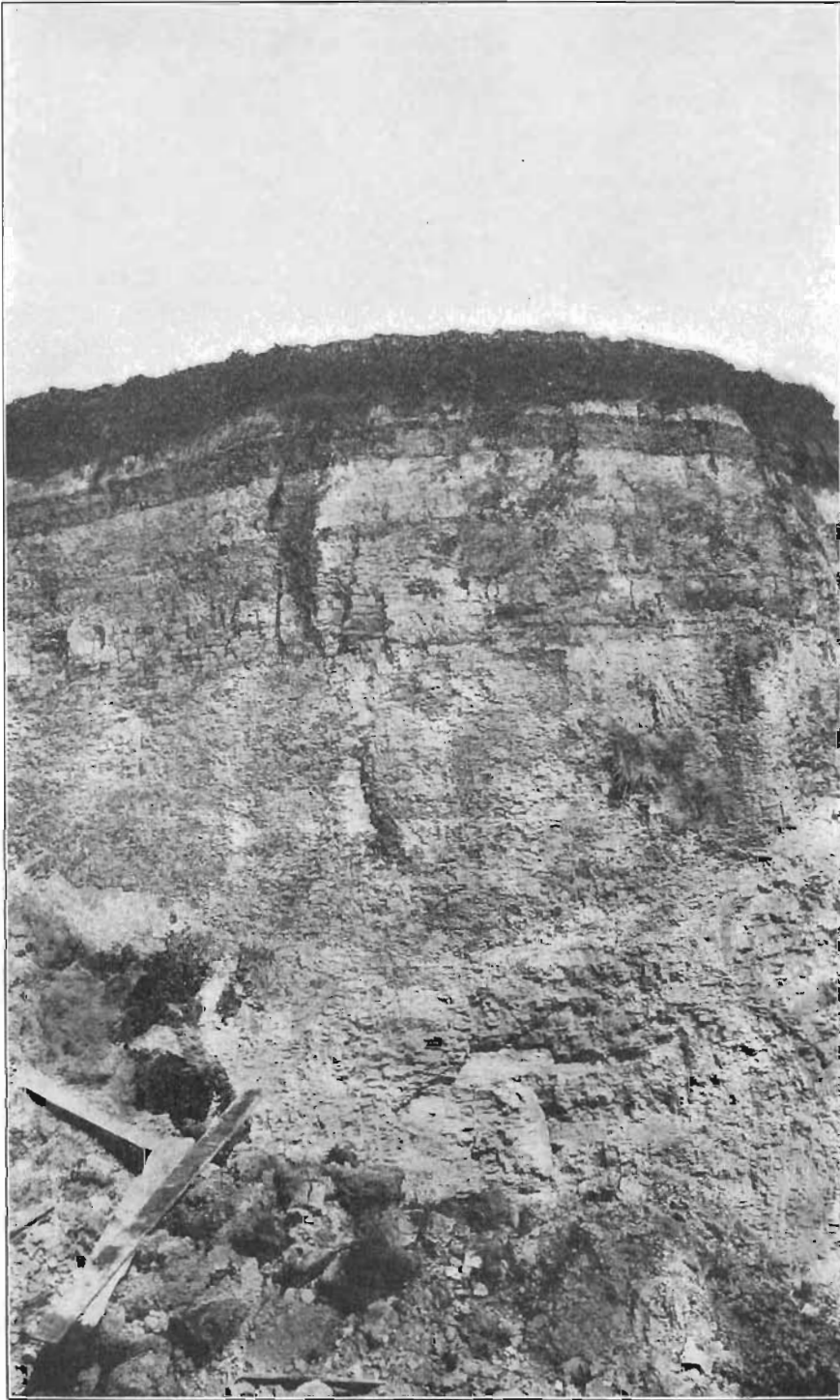

PLATE XVI. Shale pit of Mason City Brick and Tile Company. The dark layer above is the residual siliceous dolomite, Mason City, Iowa.

| | |
|----------------------|-------|
| Iron oxide..... | 5.69 |
| Lime | 5.16 |
| Magnesia | 2.90 |
| Manganese oxide..... | 0.76 |
| Potash | 4.77 |
| Soda..... | 1.12 |
| | <hr/> |
| Total fluxes..... | 20.40 |
| Moisture. | 0.85 |

Two other plants located at this place are using the Lime Creek shales. The American Brick and Tile Company opened a pit about one-half mile west of the above pit. An analysis of the clay used gave the following results:

| | |
|-----------------------|-------|
| Silica | 51.95 |
| Alumina | 18.34 |
| Combined water | 7.39 |
| | <hr/> |
| Clay and sand..... | 77.68 |
| Iron oxide..... | 7.56 |
| Lime | 4.14 |
| Magnesia | 3.26 |
| Potash..... | 1.43 |
| Soda. | 2.69 |
| | <hr/> |
| Total fluxes..... | 19.08 |
| Moisture | 0.42 |
| Sulfur trioxide | 2.76 |

RATIONAL ANALYSIS.

| | |
|----------------------|--------|
| Clay substance..... | 47.08 |
| Feldspar | 6.98 |
| Quartz | 41.45 |
| Calcium sulfate..... | 4.49 |
| | <hr/> |
| | 100.00 |

The aggregate of fluxes is comparatively high in both analyses, and accounts for their low fusion point. The presence of a liberal amount of the carbonates tends to neutralize the coloring effect of the iron and makes the range between incipient and complete fusion very small. Considerable care is necessary in burning to avoid fused pockets in the kiln and yet insure sufficient burning to prevent slaking when exposed to the action of

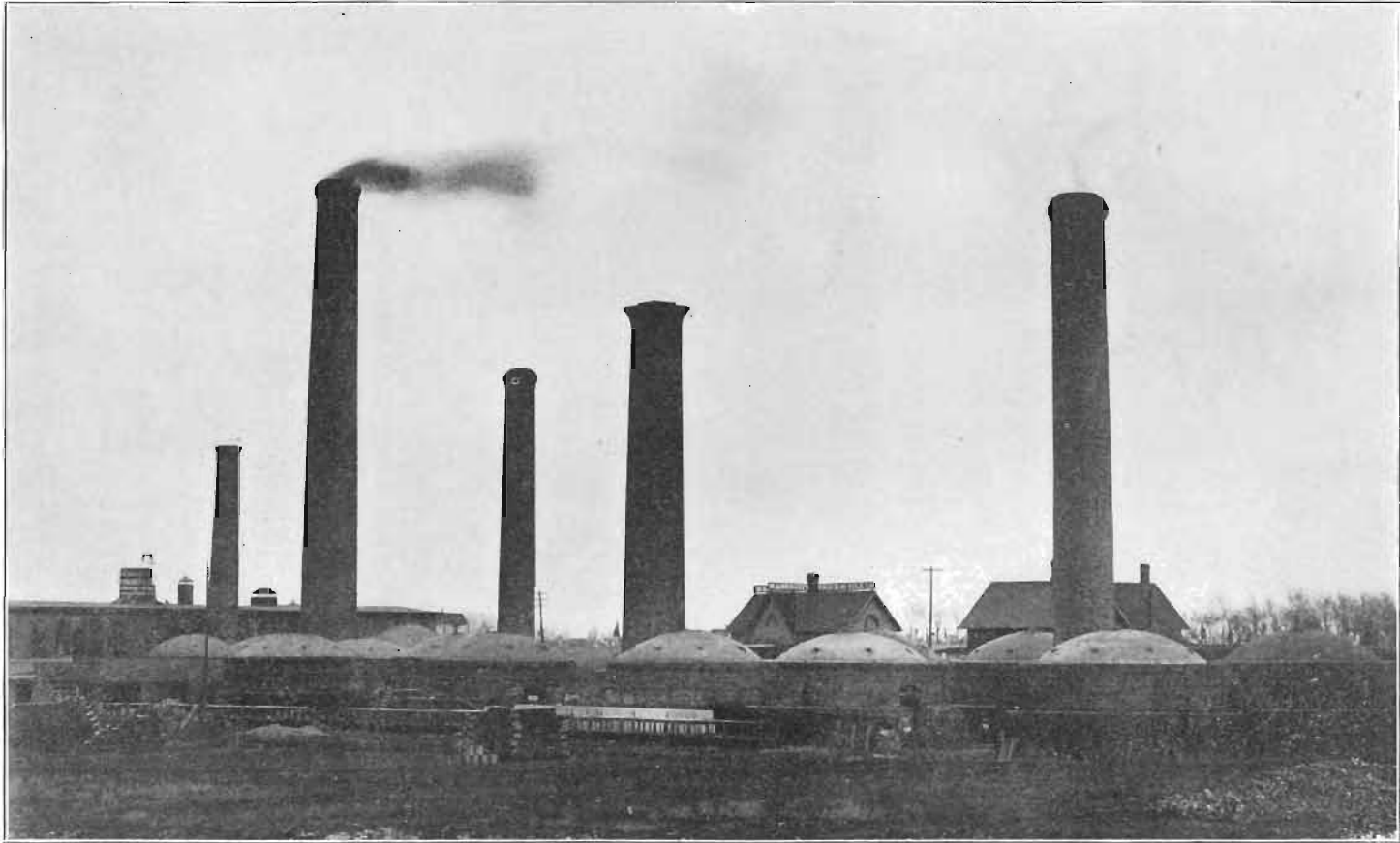

PLATE XVII. Plant of the Mason City Brick and Tile Company, Mason City, Iowa.

wetting and drying. Some attempts have been made to manufacture sewer pipe, but the lower plastic clays will not stand a sufficiently high temperature to make salt glazing a possibility. In the pit of the Mason City Brick and Tile Company the plastic shales dip to the southwest, and beds of residual siliceous dolomite appear. The residuum exerts a beneficial influence when added to the shales in all of the processes of manufacture, and greatly extends the range of temperature between incipient and complete fusion, in addition to making the ware much more refractory. It is possible that a proper blending of the shale and

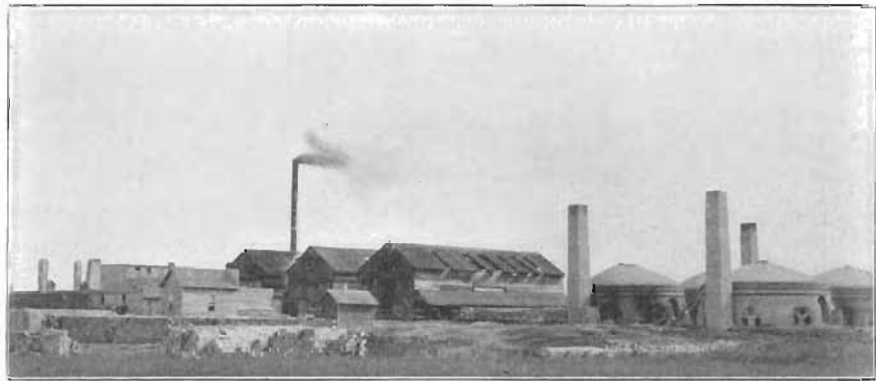

FIG. 44. Plant of the American Brick and Tile Company, Mason City, Iowa.

residuum may give a body suitable for the manufacture of paving brick and sewer pipe. Large tile are made in a sewer pipe machine and are used for culverts on the public highways.

The Lime Creek shales disappear from view west of Mason City and are not known to be accessible below Rockford. In the pit of the Mason City Brick and Tile Company they have an appreciable dip to the southwest and are soon carried below working limits.

Floyd County.—The Lime Creek shales occur more or less interruptedly from Mason City, in Cerro Gordo county, to below Rockford, in Floyd county. The most important exposures ap-

pear on the south side of the creek. The pit of the Cream City Brick and Tile Factory, west of Rockford, shows the following sequence:

| | FEET. |
|--|-------|
| 7. Drift, variable in thickness, almost absent in the bluffs near the river | 1-4 |
| 6. Limestone, marly with occasional hard ledges | 8 |
| 5. Shale, clayey, weathered zone, yellow, lower portion jointed, joints deeply stained a yellowish-brown, clay-ironstone concretions containing calcite crystals not uncommon, limonite pseudomorphs after pyrite are common above | 10 |
| 4. Shale, clayey, greenish-gray to greenish-yellow | 10 |
| 3. Shale, deep blue when wet and gray-blue when dry, more or less fissile..... | 8 |
| 2. Shale, as above but non-fissile..... | 8 |
| 1. Shale, clayey, gray, finely arenaceous, burns a creamy white (exposed) | 5 |

According to a drill section in the immediate vicinity, the shales and clays continue down about forty feet below the base of the section. All of the beds are relatively high in lime and other alkaline fluxes. Number 1 shrinks but little during burning, and can be fused with difficulty. Brick manufactured from this seam show considerable resilience when struck with a hammer, and are very tough. Its chemical composition is as follows:

| | |
|-----------------------|-------|
| Silica | 58.33 |
| Alumina | 15.54 |
| Combined water..... | 3.47 |
| <hr/> | |
| Clay and sand | 77.34 |
| Iron oxide..... | 3.84 |
| Lime | 9.42 |
| Magnesia | 3.03 |
| Potash | 1.19 |
| Soda | 1.76 |
| <hr/> | |
| Total fluxes..... | 19.24 |
| Moisture | 0.42 |
| Carbon dioxide..... | 2.02 |
| Sulfur trioxide | 1.10 |

RATIONAL ANALYSIS.

| | |
|--|-------|
| Clay substance..... | 64.47 |
| Feldspar..... | 11.13 |
| Quartz..... | 18.67 |
| Calcium sulfate and magnesium carbonate..... | 5.73 |

All of the beds below the marly layers are utilized. A wide variety of the common wares are manufactured on a small scale. No attempts have been made to develop the shales at any other point in the county.

Franklin County.—The Lime Creek shales of the Devonian are believed to constitute the indurated surface rocks over about one-third of the county. So far as known, the shales are exposed at but a single point. About half a mile south of the station at Sheffield the following section may be viewed:

| | FEET. |
|---|-------|
| 4. Shale, buff to yellow, slightly gritty. | 6 |
| 3. Shale, brownish to red | 6 |
| 2. Shale, blue..... | 21 |
| 1. Limestone (not exposed) | |

Number 2 is not wholly exposed, but its thickness has been determined by boring. In the railroad cut just east of the yard a brownish, earthy, siliceous limestone is exposed at a level corresponding to the top of number 4. It is from one to four inches thick and is fossiliferous. Occasionally calcareous concretions occur in the upper portion of number 4 in the section, but not in sufficient quantity to give serious trouble. The clay has not been extensively developed as yet, and common brick and drain tile are the only products put upon the market.

Carboniferous Period.

Practically all of the great formations of the Carboniferous contain shales or shale clays of economic importance. Of these, the Kinderhook and the Coal Measures afford the most bountiful supplies. Rocks referable to the Carboniferous comprise the

indurated rocks over nearly one-half of the surface of the state. The period may be divided into two parts, the Lower Carboniferous beds, which are prevailingly calcareous in character, and the Upper Carboniferous, in which arenaceous and argillaceous deposits predominate, with important limestone bands in the upper portion. The latter division contains all of the workable coal in the state. On account of the abundance of raw material suitable for the manufacture of clay wares, and cheap fuel, the Upper Carboniferous or Coal Measures constitute the most important formation to the clay worker in the state.

The Lower Carboniferous comprises a belt averaging from thirty to forty miles in width and extending diagonally across the state from Kossuth and Winnebago counties, on the north, to Des Moines and Lee counties, on the south. Narrow strips have been laid bare by the lower courses of the Skunk and Des Moines rivers, and unimportant detached areas appear in Story and Webster counties. Three stages represent the Lower Carboniferous in Iowa - the Kinderhook, Augusta and Saint Louis.

THE KINDERHOOK.

The Kinderhook rests unconformably on the Devonian, and in southeastern Iowa comprises a heavy shale member with important calcareous beds above. The upper member often assumes a decidedly oölitic facies. In central and northern Iowa the shale member thins rapidly and the assemblage of beds as a whole takes on a decidedly calcareous character. The shale outcrops are confined to the Mississippi river and immediate vicinity.

Des Moines County.—The Kinderhook shales attain a thickness of about 150 feet and are more extensively exposed here than in any other portion of the state. About seventy feet of the argillaceous beds lie above the water in the Mississippi river. Almost a continuous outcrop extends across the county, along the bottom of the Mississippi escarpment, occasionally extending some dis-

tance up some of the larger creeks. The shale belt is narrow and generally overlain by scarps of more highly indurated limestones. The Kinderhook section as viewed at Prospect Hill, at Burlington, is as follows:

| | FEET. |
|--|-------|
| 6. Limestone, buff, soft, sandy locally..... | 5 |
| 5. Limestone, white, oölitic..... | 3 |
| 4. Sandstone, yellowish, soft, fine-grained fossiliferous | 6 |
| 3. Limestone, argillaceous, fine-grained, often with an oölitic band in the bed of impure limestone at base..... | 18 |
| 2. Sandstone, yellowish, soft, friable, clayey..... | 25 |
| 1. Shale, blue, argillaceous, exposed..... | 60 |

At Cascade, immediately south of Burlington, the shales have been developed quite extensively in the manufacture of common brick and paving brick, by the Granite Brick Company. The small stream has uncovered a considerable area of shales, so that open pit work is possible. The pit and adjoining bluffs present an extensive section to view. The detailed section is given below.

| | FEET. |
|---|-------|
| 8. Loess, deeply iron-stained..... | 10 |
| 7. Limestone, cherty..... | 2 |
| 6. Limestone, white to brown, variegated..... | 10 |
| 5. Sandstone, fine-grained to argillaceous..... | 3 |
| 4. Limestone, hard, fine-textured..... | 12 |
| 3. Sandstone, fine-grained, argillaceous..... | 25 |
| 2. Shale, very compact and massive, highly siliceous; sandy below..... | 14 |
| 1. Shale, massive, dark-blue to blue-black, exposed.. | 16 |

Numbers 1 and 2 in the above section are utilized in the manufacture of clay goods. Both are highly siliceous and are only moderately plastic. Well sections and borings indicate that the shales extend from seventy-five to one hundred feet below the level of the water in the river. The analyses of numbers 1 and 2 give the following results:



PLATE XVIII. Pit of the Granite Brick Company, Burlington, Iowa.

THE GEOLOGY OF CLAYS.

| | 1. TOP CLAY. | 2. BOTTOM CLAY. |
|-----------------------|--------------|-----------------|
| Silica..... | 77.39 | 71.78 |
| Alumina | 5.16 | 11.41 |
| Combined water..... | 1.46 | 0.67 |
| Clay and sand..... | <u>84.01</u> | <u>83.86</u> |
| Iron oxide | 2.40 | 3.35 |
| Lime..... | 3.65 | 3.18 |
| Magnesia | 3.13 | 3.80 |
| Potash | 1.44 | 0.86 |
| Soda..... | 2.79 | 0.78 |
| Total fluxes | <u>13.41</u> | <u>11.97</u> |
| Moisture | 0.13 | 0.42 |
| Sulfur trioxide | 1.44 | 1.25 |
| Carbon dioxide..... | | 3.02 |

RATIONAL ANALYSIS.

| | | |
|--------------------------|---------------|--------------|
| Clay substance..... | 24.92 | 35.82 |
| Feldspar | 19.64 | 14.18 |
| Quartz | 51.39 | 42.14 |
| Calcium sulfate..... | 2.21 | 2.00 |
| Magnesium carbonate..... | 1.84 | 5.76 |
| Total | <u>100.00</u> | <u>99.90</u> |



FIG. 45. Plant of the Granite Brick Company, Burlington, Iowa.

The lower clay is less siliceous and contains less of the soda and potash but higher percentages of lime, magnesia and alumina. Both contain high percentages of uncombined silica or quartz and are relatively low in clay substance; facts which account for their low plasticity.

The ware burns a mottled gray-brown and becomes very hard. The fusion temperature is comparatively high, and the shrinkage is relatively small during both drying and burning. The lower clay is decidedly more argillaceous than the upper, as may be noted by the rational analysis.

While the Kinderhook shales outcrop at numerous points in the county, they have not yet been developed away from Burlington. On account of the relative ease with which they are eroded, as compared with the more resistant limestones above, the shale crops are limited to a narrow zone along the Mississippi and its larger tributaries. Their extensive development is possible in the stream valleys or by mining. Away from Burlington and immediate vicinity, a section on Oak creek, at a point where the creek breaks through into the Mississippi valley proper, may be taken as fairly representative. The following sequence may be observed:

| | FEET. |
|---|-------|
| 5. Loess..... | 8 |
| 4. Drift..... | 4 |
| 3. Limestone, buff and white, heavily bedded below, passing into siliceous shales above | 35 |
| 2. Shale, buff, sandy, forming incoherent sandstone in places | 10 |
| 1. Shale, blue, exposed..... | 20 |

Lee County.—The Kinderhook shales dip rapidly below Burlington and are carried below the water in the river before Lee county is reached. They appear in the bed of Spring creek a little more than a mile north of the Des Moines-Lee county line. But a single exposure is known within the confines of the county, and that is along the Skunk river, near the bridge on the Kansas

City division of the C., B. & Q. Ry. At Keckuk the shales lie 130 feet below low water mark, which appears to be their lowest point between Burlington and Hannibal, in Missouri.

It is apparent that the Kinderhook shales can be utilized extensively only by means of shafting and mining. This has been done to a limited extent by the J. C. Habinger Brick Works, a plant which has not been in operation for some years.

Outside of Des Moines and Lee counties, the Kinderhook shales have never been exploited, although they lie within easy reach for mining operations. In Louisa county the shales can be recognized at a number of points in the channels of the small streams which are tributary to the Iowa river. The most important exposure known may be observed just south of Elrick Junction, on the east bank of Smith creek. The sequence is as follows:

| | FEET. |
|--|-------|
| 6. Limestone irregularly bedded and leached; variable thickness. | |
| 5. Concealed..... | 10 |
| 4. Sandstone, fine-grained, soft..... | 3 |
| 3. Shale, soft, blue, unctuous..... | 9 |
| 2. Shale, dark, carbonaceous..... | 1 |
| 1. Shale, blue, with thin seams of calcareous material | 6 |

No exposures of the shale are known beyond the limits of Louisa to the northwest. In Marshall county, near LeGrand, the Kinderhook shales are reached at about ten feet below the water level in the Iowa river. The beds dip to the west, and at Marshalltown are reached at about 150 feet below the water level.

Washington County.—The Kinderhook beds comprise the surface indurated rocks over the northern and eastern portion of the county. Outcrops occur on the South English as far west as Wassonville mill, north of Wellman. Good exposures may be viewed at this point, as well as at Maple mill, Kalona and Riverside. The Kinderhook also occurs on Goose creek, south of Riverside, and doubtless underlies the drift and wash along the Iowa river. Perhaps the most typical section may be observed at Maple mill. The sequence exposed is as follows:

| | FEET. |
|---|-------|
| 4. Limestone, earthy, ferruginous and arenaceous in places; fine-grained, with thin chert layers..... | 10 |
| 3. Gritstones, fine-grained, white to buff, fossiliferous | 18 |
| 2. Limestone, drab, hard, unfossiliferous..... | ½ |
| 1. Shale, argillaceous, dark blue to drab..... | 12 |

The basal shale may be traced almost continuously from this point southeast to the base of the section at Burlington. It is suitable for structural brick and hollow ware and would probably yield a fair grade of paving brick. Some of the exposures are fairly accessible but have not been explored.

THE AUGUSTA.

Shales are not especially important in the Augusta, but near its southern extension in the state, notably in Lee county, certain beds are sufficiently argillaceous to merit attention. The most important section is about two miles below the Union depot in Keokuk, where the following sequence of beds may be viewed:

| | FEET. |
|---|-------|
| 17. Drift..... | 30 |
| 16. Shale, gray, clayey..... | 2 |
| 15. Sandstone, ferruginous..... | 1 |
| 14. Shale, black, fissile, filled with small nodular concretions..... | 3 |
| 13. Coal..... | 1½ |
| 12. Fire clay and shale passing into a coarse quartzose sandstone..... | ½ |
| 11. Limestone, brecciated, interstices filled with green clay; variable in thickness..... | 20 |
| 10. Sandstone, massive, blue, calcareous, weathers brown; fine to coarse-grained..... | 8 |
| 9. Shale, blue, argillaceous..... | 10 |
| 8. Limestone, coarse, irregular, fossiliferous..... | 3 |
| 7. Shale, blue, becoming somewhat friable in weathering..... | 4 |
| 6. Limestone, blue and brown, magnesian, irregular in development..... | 3 |
| 5. Shale, argillo-calcareous, breaking down readily to a yellowish clay..... | 18 |
| 4. Shale, calcareous, with bands of chert, and irregular layers of thin bedded, gray limestone, which are increasingly prevalent toward the base..... | 14 |

| | FEET. |
|---|-------|
| 3. Shale, blue..... | ½ |
| 2. Limestone, blue, encrinital, coarse-grained, composition and stratification somewhat var- iable, nodular chert in considerable quantity. | 12 |
| 1. Limestone, blue, encrinital; "White Ledge" of quarry men..... | 4 |

Of the above section, numbers 1 to 9, inclusive, are referred to the Augusta. At the mouth of Soap creek, from 12 to 15 feet of shale are exposed near the top of the section. These shales outcrop at numerous points along Soap creek, and have been utilized to a limited extent by the Hubinger Brick Works, but without marked success. The shales are prevailingly calcareous and low in plasticity. The expense for stripping and wasting away the unusable portions in the manufacture of clay goods adds greatly to the cost of production and renders the use of the Augusta shales commercially unprofitable. While the Augusta beds cover considerable areas in Des Moines, Henry, Louisa, Washington and Keokuk counties, the shale members are unimportant and at no place have they been developed for clay manufactures.

THE SAINT LOUIS.

No workable beds of shales or clays are known to belong to the Saint Louis in Iowa. Certain argillaceous beds have been referred to this stage of the carboniferous, but none are sufficiently pure to warrant exploitation for brick and tile.

THE COAL MEASURES.

Nearly one-third of the superficial area of the state is occupied by the Coal Measures, which supply an almost inexhaustible storehouse of raw materials suitable for the manufacture of the various grades of clay wares. The Coal Measures comprise a complicated series of sandstones, shales, limestones usually more or less argillaceous, and occasional seams of coal, all intimately

interbedded and giving place one to another, both laterally and vertically, in a most confusing way. The argillaceous beds greatly predominate, and show a wide range in color and composition and a great diversity of textures and structures. They may be grouped somewhat arbitrarily into: (1) argillaceous, (2) arenaceous, (3) carbonaceous, or bituminous, and (4) calcareous varieties.

While the types are fairly distinct, there is no sharp line separating one from another. By the gradual addition of fine sand the shales merge insensibly into sandy shales, shaly sandstones and finally into sandstones. Similarly, in many instances the shales contain some lime, and are known as calcareous shales, and may grade into marly or argillaceous limestone and even limestone, as the lime content increases. Many of the dark colored shales contain a considerable amount of organic matter, from which their color is due, and are known as carbonaceous or bituminous shales, and merge finally into impure coal. These transitions not only take place laterally in the same horizon, but vertically from one layer to another. The argillaceous shales, or true shale clays, are prevailingly light colored, the most common colors being shades of gray and blue and combinations of the two. They range from the almost white to ash-gray fire clays to the deep blues and their weathered counterparts, the red-browns. The fire clays usually form the underlays for the principal coal seams; occasionally the coal seam is absent and a carbonaceous shale only appears. Fire clays usually show no stratification or other structural features, and are non-fissile, but all those known to occur in the Coal Measures of Iowa are highly plastic. Fire clays are believed to be the old soils which produced the vegetation now preserved as coal, and are leached of most of their soluble constituents, notably the alkalis, soda, potash, lime and magnesia, and their iron constituents. These constituents constitute the fluxes, because they fuse at low temperatures, and clays which

are low in fluxes are resistant to fire, hence the name "fire clays". The more complete has been the leaching, the more resistant are the clays and the less do they shrink during the process of burning. Highly siliceous fire clays somewhat granular in texture are known as gannister, and are used in the manufacture of glass pots and other very refractory wares. The fire clays usually burn a light color, because of the partial loss of iron, which is the great coloring agent in clays. Iowa fire clays vary in thickness from a few inches to four or five feet, and are prized in the manufacture of the higher grade wares, such as face and fancy brick, pottery, terra cotta and sanitary ware.

The gray-blue and blue-gray shales often occur in beds of considerable thickness, and are quite persistent, especially in the upper Coal Measures. When unweathered, these shales occur in massive beds, the bedding planes not being apparent, and are hard and tough. When subjected to weathering agencies, stratification lines become more evident and the beds may show considerable fissility. The shales eventually slake down into an unctuous, highly plastic mass. The dark blue shales are usually denser than the lighter shades, and are better adapted to the manufacture of vitrified clay wares. The clay shales often carry impurities which are detrimental for certain uses. Of these, the commonest are crystals of gypsum and iron pyrites. The gypsum occurs in short diamond-shaped crystals to long tabular forms. Sometimes two crystals are grown together so as to form a re-entrant angle and thus producing the so-called "swallow-tailed twin." Along joint planes the crystals not uncommonly assume a radial arrangement and form rosettes. Gypsum crystals are easily recognized by their light color and transparency, the readiness with which they break into thin tablets and their softness. They can be scratched easily with the thumb nail. Gypsum does not usually occur in sufficient quantity to give trouble, save in the manufacture of fancy wares and faced goods.

Burning drives off the water of crystallization and "dead burns" the gypsum, which may show on the surface as soft, white spots.

Iron pyrite is most common in the darker colored shales, especially in the bituminous varieties, but is widely distributed, even in the lighter shades. It occurs in granular to crystalline aggregates, irregular grains and cuboidal crystals. It can be recognized easily by its golden yellow color and great hardness, being harder than steel. As in the case of gypsum iron pyrite is not detrimental, save in the manufacture of certain faced wares. In burning, pyrite serves as a flux, tending to roughen and mottle the surface by the production of dark-colored slag spots. Iron pyrite is not very stable under atmospheric conditions, and often changes to limonite or brown iron ore in the zone of weathered clay shales.

As has been said, clay shales merge insensibly through arenaceous shales, argillaceous sandstones, into sandstones. Many of the Coal Measures sections in the state show all gradations.

In certain of the arenaceous shales, the clay component so far predominates that the beds are important in clay manufactures either alone or in admixture with fat clays. The shaly sandstones can not be used alone, but when soft enough to be pulverized readily can be used with fat clays often to good advantage, as they facilitate drying, prevent undue shrinkage and help the ware hold its shape through both drying and burning.

Bituminous shales are usually distinctly fissile, breaking readily into thin lamellae, and generally accompany coal seams. Occasionally coal seams are absent. The carbonaceous matter may be present as a solid resembling fine particles of coal of a charry nature, or in some of the brown shales the carbonaceous matter occurs in the form of crude petroleum. Samples of oil shales have a decidedly petroleum odor and carry as high as 15 per cent of crude petroleum. Bituminous shales shrink greatly during drying and burning, and as a consequence are not prized in the

clay working industries. They are used, however, to a limited extent by mingling with other clay deposits.

The calcareous shales are not important in the lower Coal Measures, but assume greater importance in the upper series. The so-called "cap-rock" lying above certain coal seams, is usually calcareous and highly fossiliferous. Calcareous shales grade insensibly through argillaceous limestones to limestones. In addition to the lime which may be present in a finely divided state and disseminated throughout the entire mass, calcareous shales often carry lime concretions which interfere seriously with its use in the manufacture of clay products.

While the Coal Measures are believed to be present in more than one-half of the ninety-nine counties in the state, the clay shales have been developed for the manufacture of clay goods in but sixteen. Over the entire section covered by the Coal Measures, a thick mantle of drift greatly obscures the outcrops of the indurated rocks. Notwithstanding the thick blanket of glacial debris, the larger streams and their immediate tributaries have exposed numerous outcrops of the older rocks. From a purely geological standpoint it is found convenient to separate the Coal Measures into a lower series, typically developed along the Des Moines river, and appropriately designated the Des Moines stage; and an upper series characteristically developed along the Missouri river and with equal propriety designated the Missourian stage of the Upper Carboniferous. The Des Moines stage is characterized by a great predominance of shales of the argillaceous, bituminous and arenaceous types, and sandstones, with most of the workable coal seams of the state, while calcareous shales and limestones are much more prominently developed members in the Missourian stage. In the present discussion the division is believed to be unimportant, and no attempt is made to separate one from the other.

The leading outcrops where clay shales are available are described briefly. The sections are grouped by counties, the counties being taken in alphabetical order. On account of the large number of exposures it is manifestly impossible to mention them all. An attempt is made, however, to treat the most important for each district.

Adair County.—The upper Coal Measures lie directly beneath the drift over the larger portion of the county. Beds supposedly of Cretaceous age overlap the Coal Measures in the western portion. The thick drift sheet, in the absence of large streams effectually obscures the indurated beds. Shales are exposed in one or two inaccessible localities, and as yet they have not been developed. South of Adair a two-foot vein of coal has been mined to some extent. Above it is a heavy shale. Below it is a fire clay, and both clay seams might be mined profitably in connection with the coal.

Adams County.—Good shale outcrops are unknown. At the mining camps of Briscoe, Carbon and Eureka, shales suitable for use in clay working are penetrated in sinking shafts for coal, and are within easy mining distance of the surface. Unimportant exposures appear along the Middle Nodaway river, accompanied by a thin seam of coal, but none of the Coal Measure shales have been developed in the county. A bed of fire clay lies below the principal coal vein worked, is fairly persistent and undoubtedly would furnish a good body for the various grades of dry pressed brick.

Appanoose County.—The shale beds are comparatively persistent and fairly uniform, and are separated by beds of limestone which are remarkably constant. The principal bands are known locally as the "floating rock", "fifty-foot limestone", "seventeen-foot limestone", the "cap rock" and the "bottom rock". The terms are referable to the principal coal seam known as the Centerville vein or mystic seam of Keyes and Bain.

The general section published in the "Geology of Appanoose County", and appended below, gives a good idea of the sequence of beds and their relative importance.

| | FEET. | INCHES. |
|--|----------|---------|
| 17. Limestone, gray, sub-crystalline, seen in the railway cut near Anchor No. 1 mine at Centerville, and known among the miners as the "floating rock"... | 2 to 4 | |
| 16. Shale, argillaceous, color variable..... | 12 to 30 | |
| 15. Limestone, heavy ledges, exposed along the Manson branch and Cooper creek at Centerville as well as at numerous other points in the county, the "fifty foot" limestone..... | 4 to 10 | |
| 14. Shale, argillaceous, blue and red in color | 14 | |
| 13. Shale, arenaceous, frequently forming a well defined sandstone..... | 8 | |
| 12. Shale, argillaceous, blue and gray | 10 | |
| 11. Limestone, somewhat variable in thickness; exposed along the C., M. & St. P. railway between Mystic and Brazil, known as the "seventeen-foot limestone" or "little rock"..... | 1 to 3 | |
| 10. Shale, sometimes gray, frequently bituminous and pyritiferous..... | 7 | |
| 9. Limestone, sometimes gray, and coarsely sub-crystalline as at the Lodwick mine, Mystic; sometimes fine-grained, bituminous, and grading into the shales above and below, as at the Thistle mine, Cincinnati, known as the "cap rock"..... | 2 to 4 | |
| 8. Shale, usually bituminous, and known as "slate"; occasionally in part soft and clay like, then known as clod; at times heavy and homogeneous non-fissile, in which form it is known as "black bat"..... | 1 to 3 | |
| 7. Coal, upper bench, usually..... | 1 | 8-10 |
| 6. Clay parting "mud band"..... | | 2- 3 |
| 5. Coal, lower bench, usually..... | | 8-10 |
| 4. Clay parting the "dutchman"..... | | ½ |
| 3. Coal, frequently impure..... | | 2- 3 |
| 2. Fire clay..... | 1 to 6 | |
| 1. Limestone, "bottom rock", well exposed along Walnut creek at Mystic..... | 3 | 6 |

It is obvious from the above section that important beds of clay shales occur between the limestones, and they are much more persistent than those which occur in many of the other Coal Measure counties. The entire section is exposed in the central and north central portions of the county along the Chariton river and Cooper and Walnut creeks; the lowest beds appearing along the latter creek, at Mystic and Brazil. Away from the larger streams and the central portion of the county, the thick veneer of drift effectually conceals the stratified rocks, although the Coal Measures cover the entire county.

At Centerville only, have the clay shales been developed. The Centerville Brick and Tile Company are using the uppermost member, number 16 in the general section. Formerly their pit was located south of the Keokuk and Western railway, near the shaft of the Scandinavian Coal Company and their own plant. At present the company has opened a pit south of the Iowa Central depot and east of the Keokuk and Western track. The shale developed is covered by a thin mantle of loess and drift, the "float rock" having been removed by erosion, and some twelve to fifteen feet of shale clay are available. The clays utilized are of a pale, yellowish-brown color above, and grade downward into gray-blue layers, stained a yellowish-brown along the joints. The entire assemblage of beds is finely arenaceous, works somewhat short and is slightly calcareous. The clay is loaded by hand into flat cars and hauled to the plant, a distance of about one mile, where it is shoveled on a conveyer which leads to a dry-pan. The ware burns a pale red and is fairly strong. The clay is adapted to both dry press and stiff mud processes. It does not appear to be well adapted to the manufacture of paving brick and drain tile. In the vicinity of Centerville the upper shales are exposed quite freely along the stream ways, but could not be developed extensively, save by mining, on account of heavy strip-ping. In the vicinity of Mystic and Brazil the lower shales

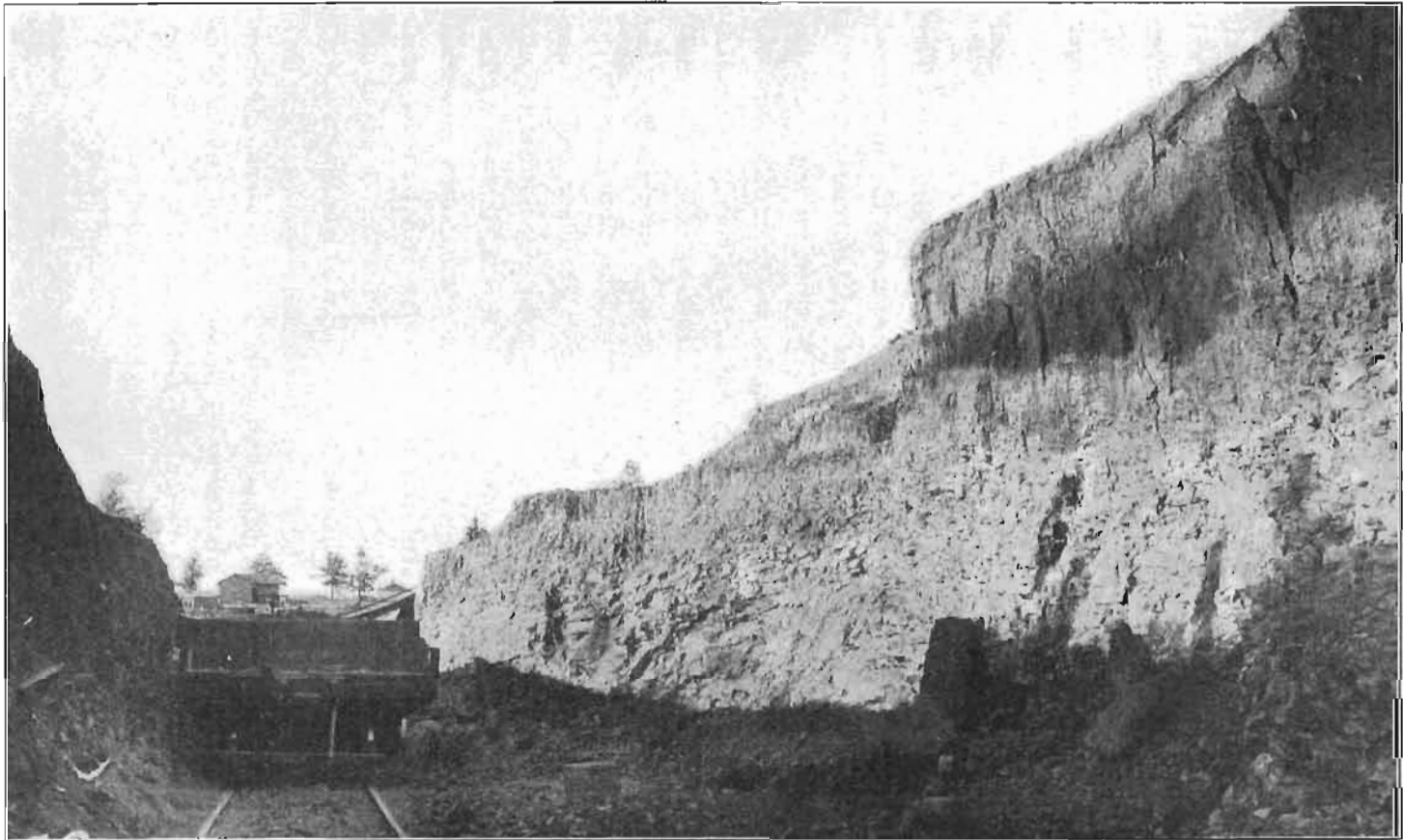

PLATE XIX. Pit of the Centerville Brick and Tile Company, Centerville, Iowa.

appear in the bluff walls of Walnut creek. Some fifteen feet of shales below "bottom rock" are visible as in the following section which may be taken to be fairly representative.

SECTION ON WALNUT CREEK AT MYSTIC.

| | FEET. | INCHES. |
|--|-------|---------|
| 10. Drift..... | 12 | |
| 9. Limestone, heavily bedded, gray, fossiliferous..... | 2 | 10 |
| 8. Shale, bituminous, fissile..... | 1 | |
| 7. Coal..... | 1 | 6 |
| 6. Clay parting..... | | 2 |
| 5. Coal with some pyrite near base..... | 1 | |
| 4. Fire clay..... | 1 | 6 |
| 3. Limestone, heavily bedded, fossiliferous.. | 2 | 10 |
| 2. Shale, gray, clayey,..... | 11 | |
| 1. Shale, blue, clayey (exposed to water level). | 4 | |

The lower shales could not be developed generally, save by mining. Limited areas uncovered along the streams might be developed cheaply.

A few shale outcrops are known to appear along Sugar creek, in the northeast corner of the county, near Foster. No attempts have been made to prospect, explore or exploit them.

Boone County.—As in the foregoing counties, Boone lies wholly within the Coal Measure area. Outcrops are limited to the immediate vicinity of the Des Moines river, with the exception of an unimportant exposure along Squaw creek, near the northeast corner of the county. The Des Moines river has cut a deep trench across the county from north to south, and numerous shale crops appear in the steep valley walls, generally more or less obscured by drift-slides and talus slopes. The best sections are exposed near Boone, along the Des Moines river and small tributaries. The pit at the Boone Clay Works, located southwest of Boone, on a small tributary of the Des Moines river, shows the following sequence of beds:



FIG. 46. Pit of the Boone Clay Works, Boone, Iowa.

| | FEET. |
|---|-------|
| 9. Drift..... | 15+ |
| 8. Potter's clay..... | 1½ |
| 7. Clay shale, gray-blue..... | 2 |
| 6. Clay shale, gritty, ash colored, iron-stained in the upper part..... | 4 |
| 5. Clay shale, variegated, red, blue and gray..... | 12 |
| 4. Shale, ochreous band, stained a deep red..... | ¾ |
| 3. Clay shale, similar to No. 6..... | 2 |
| 2. Fire clay..... | 1½ |
| 1. Shale, impure, exposed..... | 3 |

The drift here, as in most of the exposures in the county, abounds in lime pebbles and bowlders, and must be removed. Number 5 is the principal clay used. It is of excellent quality and contains sufficient iron to give a good color to the finished product. The entire assemblage below the drift, blends to good advantage and affords first-class material for the manufacture of building and paving brick, and drain tile. Directly west of Boone, the Des Moines river has removed the drift from a con-

siderable area, exposing some seventy feet of shales, which are being developed by the Boone Brick, Tile and Paving Company. The beds exposed in the pit are as follows:



FIG. 47. Plant of the Boone Clay Works Boone, Iowa.

PIT SECTION OF BOONE BRICK, TILE AND PAVING COMPANY.

| | FEET. |
|---|-------|
| 8. Drift and talus, varying in thickness, average for pit at the present time..... | 5 |
| 7. Shale, variegated, gypseous, much weathered and shrinks considerably during drying and burning | 15 |
| 6. Shale, gray-blue, arenaceous below, in places a hard ledge appears and must be wasted..... | 4 |
| 5. Shale, purplish, variegated, somewhat fissile..... | 4 |
| 4. Sandstone, argillaceous in part, hard ledge appears in places..... | 4 |
| 3. Shale, dense, gray-blue to deep blue, but slightly fissile, the most important bed in the pit..... | 14 |
| 2. Shale, bluish-gray, weathers almost white, finely arenaceous, massive..... | 4 |
| 1. Shale, dark blue to bluish-black, gypseous. | |

At the present time numbers 2 to 7, inclusive, are being developed. Portions of 4 and 6 must be wasted. Number 7 is used largely in the manufacture of hollow ware, while number 3 gives

the best results when vitrified wares are desired. The base of number 1 is about twenty feet above the Des Moines river, while the plant is located on the bluff, about 200 feet above. The clay is loaded on small cars and pulled up an incline by means of a rope. An ordinary hoisting engine is used. The weight of the empty car is sufficient to carry it back. The plant is turning out an excellent quality of paving brick, common builders and hollow ware. Chemical analyses were made of the principal seams. The results are given in tabular form below.

| | 1 | 2 | 3 |
|----------------------|-------|-------|-------|
| Silica..... | 47.40 | 73.70 | 53.40 |
| Alumina..... | 22.20 | 16.60 | 20.39 |
| Combined water..... | 7.90 | 4.30 | 8.71 |
| Clay and sand | 77.50 | 94.60 | 82.50 |
| Iron oxide..... | 12.40 | 0.20 | 12.24 |
| Lime..... | 0.70 | 0.10 | 0.99 |
| Magnesia..... | 1.10 | 1.60 | 1.42 |
| Potash..... | 3.10 | 0.70 | 1.42 |
| Soda..... | 0.50 | 0.30 | 0.71 |
| Total fluxes..... | 17.80 | 2.90 | 16.78 |
| Moisture..... | 2.10 | 0.70 | 0.52 |
| Sulfur trioxide..... | 2.40 | 1.70 | 0.55 |

RATIONAL ANALYSES.

| | | | |
|---|--------|--------|--------|
| Clay substance..... | 74.90 | 37.13 | 67.06 |
| Feldspar..... | 8.81 | 15.33 | 4.82 |
| Quartz..... | 12.70 | 47.54 | 28.12 |
| Calcium sulfate and Magnesium sulfate | 3.59 | | |
| | 100.00 | 100.00 | 100.00 |

No. 1 was selected from one of the test pits before the plant was opened, and doubtless came from number 5 in the section; number 2 came from 6 in the section. Number 3 gives the composition of a sample compounded from all of the argillaceous members which appear in the section, according to their relative thicknesses.



PLATE XX. Pit of the Boone Brick, Tile and Paving Company, Boone, Iowa.

While the shales are exposed at numerous other points in the county, no attempt has been made to utilize them, save in the instances mentioned. The great thickness of the drift is a serious obstacle to their economic development, even along the larger streams. The contact between the drift and the Coal Measures is a plane of weakness, and drift-slides are of common occurrence. Where the slopes are subject to inundation of this kind, great expense is entailed in the removal of landslides. In some instances it is found to be more economical to abandon the pit.

Dallas County.—Dallas county is provided with an abundance of shale clays of excellent quality, and are unusually accessible in the southern portion, along the Raccoon river. The Coal Measures cover the entire county, but outcrops are rare in the northern half of the county, owing to the thickening of the drift northward and the absence of large streams, save the North Raccoon. Some of the best shale sections are given below, and may be considered to be fairly representative. The shale series exposed near Booneville is as follows:

| | FEET. |
|--|---------------|
| 14. Drift, overlain by loess..... | 30 |
| 13. Sandstone | 10 |
| 12. Shale, black, fissile..... | 1 |
| 11. Shales, gray and red..... | 10 |
| 10. Shales, black..... | 1 |
| 9. Shales, gray | 3 |
| 8. Coal | $\frac{3}{4}$ |
| 7. Shales, gray..... | 9 |
| 6. Limestone, fragmental, fossiliferous..... | 2 |
| 5. Shales, gray..... | 13 |
| 4. Limestone | 2 |
| 3. Shales | 16 |
| 2. Sandstone..... | $\frac{1}{4}$ |
| 1. Unexposed to river..... | 20 |

Continuing westward from Booneville to Van Meter, the Platt Pressed and Fire Brick Company are developing the clay shales south of the Raccoon and well up the bluff. The pit shows the following layers:

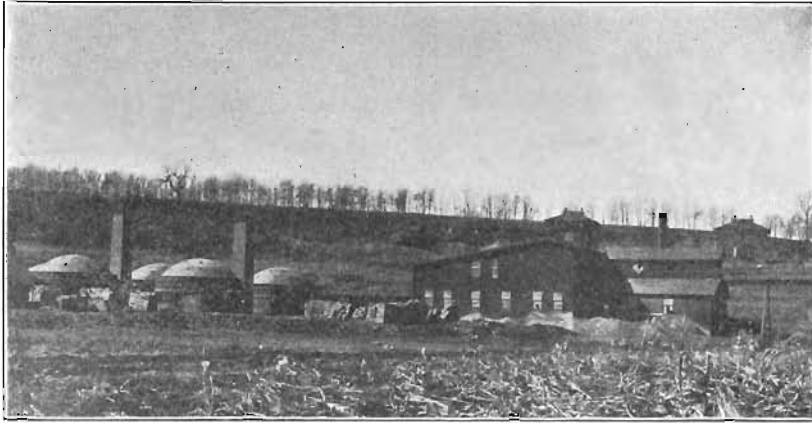

FIG. 48. Plant of Platt Pressed and Fire Brick Company, Van Meter, Iowa.

| | FEET. |
|--|----------------|
| 5. Drift and waste..... | 1 to 4 |
| 4. Sandstone | $\frac{2}{3}$ |
| 3. Shale, gray, arenaceous..... | 2 |
| 2. Sandstone, blue, compact..... | $1\frac{1}{2}$ |
| 1. Shales, variegated, red and gray, exposed | 15 |

These clays are developed for the manufacture of red brick and tile. The firm also manufactures buff brick and fire brick. The raw material is obtained from a depth of some 265 feet, by mining out the three to seven feet which occurs between the upper and middle coal seams of the locality. The lower part of the section at the mine is as follows:

| | FEET. | INCHES. |
|----------------------------------|----------------|-------------------|
| 9. Shale, argillaceous..... | 90 | |
| 8. Coal | 1 | to $1\frac{1}{2}$ |
| 7. Fire clay, impure, gray | 2 | to 4 |
| 6. Fire clay, "flint clay" | | 6 to 18 |
| 5. Fire clay..... | | 6 to 18 |
| 4. Coal | $1\frac{1}{2}$ | to 4 |
| 3. Sandstone..... | 16 | |
| 2. Shale, bituminous..... | 1 | |
| 1. Coal | 2 | to 4 |

Number 7 is used in the manufacture of buff brick, either alone or mixed with number 5. Number 6 gives a good grade of fire brick,

Number 9 burns a pink color and gives a good strong brick. By mixing the mined clays with the surface red burning shale, almost any desired color can be secured. The buff burning clay furnishes a good body for the manufacture of the various shades of mottled and ornamental brick and enameled wares. The three grades of fire clays have been analyzed, and gave the following results:

| | No. 5. | No. 6. |
|--------------------|--------|--------|
| Silica..... | 55.11 | 86.63 |
| Alumina..... | 26.71 | 10.92 |
| Iron oxide..... | 4.28 | 0.10 |
| Sulfuric acid..... | 4.16 | |
| Water..... | 9.69 | 2.33 |
| | <hr/> | <hr/> |
| | 99.96 | 99.97 |

The analyst was W. S. Robinson, chief chemist of the Union Pacific railway, Omaha, Nebraska. While the constituents are given in the form of oxides, the iron in number 5 doubtless occurs in the form of the sulfide. None of the strong fluxes, soda, potash, lime and magnesia, were reported. Number 6 is highly siliceous and extraordinarily low in fluxing constituents and ought, when properly manufactured, to yield a superior quality of fire brick.

Number 7 was analyzed by Charles Ferry, of Troy, New York, and gave the following results:

| | |
|----------------------|-------|
| Silica..... | 53.21 |
| Alumina..... | 25.74 |
| Combined water..... | 10.19 |
| | <hr/> |
| Clay and sand..... | 89.14 |
| Iron oxide..... | 7.07 |
| Lime..... | 0.48 |
| Magnesia..... | 0.98 |
| Potash and soda..... | 4.30 |
| | <hr/> |
| Total fluxes..... | 12.83 |

The clay is manufactured, dry press process, into an exceedingly dense, strong, homogeneous brick, much prized for front

brick and interior finish work. It is one of the most durable dry press brick on the market.

About three miles east of Redfield, near Cottonwood mills, fifty feet of Coal Measure strata appear in the bluff north of the river. Shales greatly predominate and but little stripping would be required in their utilization. The section is as follows:

| | FEET. |
|--------------------------------------|-------|
| 11. Drift..... | 3 |
| 10. Shales, sandy, buff..... | 10 |
| 9. Sandstone, yellow..... | ½ |
| 8. Shales, sandy, buff..... | 1 |
| 7. Shales, blue..... | 1 |
| 6. Sandstone, yellow, soft..... | 3 |
| 5. Shales, sandy, buff and gray..... | 10 |
| 4. Sandstone, soft, gray..... | 3 |
| 3. Shales, sandy, blue..... | 12 |
| 2. Sandstone, yellow..... | 1 |
| 1. Shales, sandy..... | 4 |

South of Redfield, near the junction of the Middle and South forks of the Raccoon river, at "Hanging Rock," a massive sandstone makes up the principal portion of the section. In the west edge of the town, close to the right-of-way of the Chicago, Milwaukee & St. Paul railway, the sandstone member has entirely disappeared and a splendid series of shales may be observed. The clay pit of the Redfield Brick and Tile Company displays the following layers:

| | FEET. |
|--|-------|
| 5. Drift and hillside wash..... | 0-10 |
| 4. Shale clays, variegated, yellow, gray, blue, purple and red. Fissility somewhat obscured by weathering. | 8 |
| 3. Shale, red, fissile, with occasional very hard, hematite concretions..... | 4 |
| 2. Shale, blue to blue-gray when weathered; jointed, contains occasional finely arenaceous streaks, and limonitic seams..... | 12 |
| 1. Fire clay..... | 4 |

The plant is very favorably located. Practically no stripping is required and the transference of raw material to the factory and the manufactured product from the factory to the car, can be

very cheaply done. All of the shale beds are used, and the composite is well adapted to the manufacture of all grades of common brick, paving brick, sidewalk brick, drain tile and hollow block. West of Redfield the arenaceous members again become prominent. Near the old mill site south of Linden, on the Middle Raccoon, the following section appears:

| | FEET. |
|---|---------------|
| 12. Drift..... | |
| 11. Sandstone, buff, shaly in part..... | 7 |
| 10. Shales, gray, sandy above..... | 8 |
| 9. Coal..... | $\frac{1}{2}$ |
| 8. Shales, gray..... | 6 |
| 7. Limestone, gray, very fossiliferous..... | 1 |
| 6. Shales, gray..... | 6 |
| 5. Limestone, buff, 18-inch layer below, brecciated and yellow above..... | 4 |
| 4. Shales, gray..... | 12 |
| 3. Sandstone, gray..... | 2 |
| 2. Shales, gray..... | 13 |
| 1. Clay shales, red, exposed to river..... | 2 |

The thin seam of coal is forty-six feet above the river.

North of the Middle Raccoon there are few exposures of the Coal Measures. Just north of Adel, on a small tributary of the North Raccoon river, much obscured siliceous and argillaceous beds may be observed. A local brick plant has developed the beds to a limited extent. The pit shows the following layers:

| | FEET. |
|---|---------------|
| 3. Shale, variegated, siliceous and gypseous, with hard ferruginous and clayey concretions..... | 14 |
| 2. Coal, impure, clayey and with calcareous layers..... | $\frac{1}{3}$ |
| 1. Shale, light gray to white at top, variegated below (exposed)..... | |

To the west the shales cut out rapidly, and within one hundred feet the drift rests directly on number 1. Common brick and drain tile only are attempted.

Just above High Bridge the Coal Measures appear in the west bluff. The following beds may be observed:

| | FEET. | INCHES |
|---|-------|--------|
| 5. Drift | 4 | |
| 4. Sandstone, thinly bedded | 3 | |
| 3. Shale, light colored, with sandy concretions, grading downward into bituminous shale. | 18 | |
| 2. Coal | 1 | 8 |
| 1. Fire clay, exposed | | 4 |

The above section may be accepted as being a fair example of the Coal Measures for the northeastern portion of the county. No attempt has been made to utilize the beds in this vicinity.

Decatur county.—The county lies wholly within the Coal Measures. The lower measures appear sparingly along the Grand river and in the southeast corner of the county. The shale clays have not been utilized, and are not very accessible. Along a small ravine, north of Davis City, the following shale section belonging to the Des Moines stage, may be observed:

| | FEET. |
|---|-------|
| 5. Shale | 3 |
| 4. Shale, black, fissile..... | 1 |
| 3. Shale, drab, arenaceous..... | 4 |
| 2. Shale, sandy, yellow..... | 6 |
| 1. Shale, drab, clayey, with several thin bands of blue-black, non-fossiliferous limestone..... | 4 |

By mingling numbers 2 to 5, doubtless a good strong brick could be produced. None of the beds are especially well adapted to the manufacture of clay wares, and the bituminous shale might have to be rejected. The heavy stripping would make extensive open pit work impossible, and mining would scarcely be found practicable.

The upper Coal Measures carry so much lime that good shale sections are rare. One of the best in the county may be viewed at DeKalb, near the wagon bridge just north of the railway station. The section exposed is as follows:

| | FEET. |
|--|-------|
| 5. Limestone, thinly bedded, very fossiliferous..... | 2 |
| 4. Shale, soft, gray..... | 2 |
| 3. Shale, fine, black, fissile..... | 1 |
| 2. Shale, black, soft..... | 2½ |
| 1. Shale, drab..... | 4 |

Here, again, the shales could be worked only by mining, and while the limestone would afford a good roof, the quality of the raw material would hardly warrant the expense.

Des Moines County.—The Coal Measures occupy small detached areas in the southwest corner of the county, near the Skunk river. Southwest of Danville the following beds may be viewed:

| | FEET. | INCHES. |
|---|-------|---------|
| 7. Drift..... | 20 | |
| 6. Shale, light colored..... | 20 | |
| 5. Shale, bituminous..... | 3 | 2 |
| 4. Coal..... | 1 | |
| 3. Fire clay..... | 3 | 6 |
| 2. Shale, brownish, gray, gritty..... | 1 | 6 |
| 1. Shale, light, brownish, sandy in places(exposed) | 4 | |

While the area is small and at present somewhat inaccessible, the shale clays are excellently adapted to the manufacture of the various grades of clay wares. Certain of the layers below the coal seam have for more than half a century been used in the manufacture of pottery.

On the farm of B. B. Jester, near Parrish, a clay shale is being developed which has gained quite a local reputation as a fire clay. It lies below the thin coal seam, and attains a thickness of four feet. The section here exposed is as follows:

| | FEET. |
|--|-------|
| 5. Drift..... | 10 |
| 4. Shales, argillaceous..... | 20 |
| 3. Shale, hard, dark gray in color above, bituminous below..... | 3 |
| 2. Coal..... | 1+ |
| 1. Shale..... | 8 |

The coal vein has been worked from time to time since 1834. Number 1 in the section is separable into three parts, consisting of three and one-half feet of fire clay, gray, slightly iron-stained; one and one-half feet of hard, brownish-gray, gritty shale and at the bottom four feet of lighter brownish-gray clay, quite hard. The lowest layer is best adapted to the manufacture of fire brick

and when washed can be used for a fine grade of pottery. Chemical analyses, both complete and rational, of the fire clay are given below:

| | |
|----------------------|-------|
| Silica | 74.82 |
| Alumina | 15.54 |
| Combined water | 4.97 |
| | <hr/> |
| Clay and sand | 95.33 |
| Iron oxide | 2.72 |
| Lime | 0.73 |
| Magnesia | 0.45 |
| Potash | 0.32 |
| Soda | 0.38 |
| | <hr/> |
| Total fluxes..... | 4.60 |
| Moisture | 0.22 |

RATIONAL ANALYSIS.

| | |
|---------------------|--------|
| Clay substance..... | 21.77 |
| Feldspar..... | 9.79 |
| Quartz | 68.94 |
| | <hr/> |
| | 100.50 |

The total fluxes calculated on a water free basis amount to 4.85 per cent. The physical tests and furnace tests support the chemical analyses and indicate that the clay deserves more attention than it has yet received.

The clays at present used by the local potteries are gypseous and concretionary and washing is necessary. The removal of these impurities is accomplished by mixing the clay to a slurry with water, then passing over two screens, an upper 60-mesh and a lower 70-mesh to the inch.

The screens vibrate longitudinally and the coarser particles are removed at one end. This slip is run into a tank dug into the ground, where the water evaporates. If arrangements were such that the water could be tapped off instead of being permitted to evaporate the soluble matter could be removed instead of being permitted to remain in the clay as at present and later

appear in the surface of the unglazed ware as a white efflorescence.

Fremont County. The upper Coal Measures are believed to cover the entire county and lie immediately beneath the drift. They are prevailingly argillaceous or marly in character with immediate beds of hard limestone exposed in nearly every section. At Hamburg in the southwest portion of the county, just south of the school house on D street, a shallow pit shows the following section:

| | FEET. |
|--|-------|
| 5. Shale, calcareous, variegated, fossiliferous; containing hard nodules of pyrite and lime | 15 |
| 4. Limestone, impure, gritty, fossiliferous | 18 |
| 3. Shales, red and gray | 4 |
| 2. Limestone, impure, color dark gray | 2 |
| 1. Shale, gray, argillaceous | 12 |

The above section may be taken as fairly representative. No attempt, as yet, has been made to utilize the indurated beds at this point. About three miles east of Nebraska City Junction a stratum of shale with a thickness of four or five feet is exposed immediately above a ledge of sandstone. The shale is quite free from grit and varies from pale to dark red in color. Some prospecting has been done with a view to using it for paint. It would doubtless give better results in the manufacture of clay wares. No other shale sections worthy of notice are known to exist in the county.

Greene County.—The county lies only partially within the Coal Measures, the western portion being overlapped by the Cretaceous. The few outcrops of shales in the county appear along the Raccoon river, southeast of Jefferson, but at only one point are they utilized, and that is at Grand Junction, where the raw material is mined in conjunction with the mining of an eighteen-inch coal vein. The Grand Junction Brick and Tile Company has operated successfully for a number of years, notwithstanding they could obtain their clay only by mining. The coal seam

worked lies about 140 feet below the surface, and the clay used is a semi-fire clay which lies directly under the coal. The principal output is drain tile, although some brick are produced. The ware burns buff to pale red and gives excellent satisfaction.

Along the Raccoon river, near the southeast corner of the county, shale outcrops may be noted. Usually the drift mantle is quite thick, and considerable stripping would be necessary. In some instances the shales exposed are of excellent quality, but not very accessible. Near the Riverside mine the following section may be observed:

| | FEET. |
|---|----------|
| 5. Drift, variable in thickness up to | 50 |
| 4. Sandstone | 1 to 2 |
| 3. Shale, plastic | 2 |
| 2. Shale, argillaceous, more or less massive. | 3½ |
| 1. Sandstone | Exposed. |

The shaft section in the immediate vicinity demonstrates that the sandstone is forty feet in thickness and is underlain by twenty feet of shale, in part bituminous, which rests directly upon the principal coal seam of the district. The coal is underlain by the usual layer of fire clay. No attempts have been made, as yet, to utilize the argillaceous deposits.

Guthrie County.—The Cretaceous is believed to cover the greater portion of the county, but the Coal Measures occur in the east quarter and appear along the Middle Raccoon river into the northwest corner township. The best exposures may be viewed along the Raccoon river. Shale clays constitute an important part of the Coal Measure series as developed in the county. The following sections may be considered fairly representative for the county. Southwest of Linden, in Dallas county, near the old Tann mill site, on the Middle Raccoon, the following beds are more or less imperfectly visible.

| | FEET. | INCHES. |
|---|-------|---------|
| 16. Drift, Kansan..... | 6 | 4 |
| 15. Limestone, thin bedded, buff | 1 | 6 |
| 14. Shales, gray, argillaceous; becoming blue below | 20 | |
| 13. Limestone, nodular, impure..... | | 6 |
| 12. Shales, bituminous, mixed with impure coal..... | 1 | 6 |
| 11. Shales, light colored..... | 8 | |
| 10. Sandstone, coarse, yellow, with flakes of coaly matter and remains of poorly preserved Neuropteris..... | 10 | |
| 9. Shales, arenaceous, blue and yellow.... | 3 | |
| 8. Coal, impure. | | 6 |
| 7. Shales, dark and light blue..... | 7 | |
| 6. Limestone, thin, irregular..... | 1 | |
| 5. Shales, blue..... | 2 | |
| 4. Limestone, earthy, irregularly bedded.. | 1 | 6 |
| 3. Shales, blue..... | 1 | |
| 2. Limestone, impure | 1 | |
| 1. Shales, blue and gray, exposed about twenty feet above the river..... | 2 | |

Northward exposures are not uncommon, and good outcrops of clay shales may be seen in the vicinity of Panora. The pit of the Panora Brick and Tile Company shows the following sequence.

| | FEET. |
|--|-------|
| 3. Shale, clay, argillaceous, red..... | 12 |
| 2. Coal and bituminous shale | 2 |
| 1. Shale, argillaceous sandy, blue to white with irregular bands of calcareous material; exposed to within six feet of the river ... | 18 |

Practically the entire section is utilized, and very little stripping is necessary. Drain tile is the chief product. The raw material is of good quality and vitrified ware could be manufactured satisfactorily if desired.

Panora is the only point in the county where the shales have been used as yet. Other outcrops, quite accessible, are not rare. About one-half mile north of Glendon, in a cut on the Rock Island railway, excellent material is exposed, although some stripping would be required in the cut. In the near neighborhood, doubtless, areas could be found where the upper beds have

been removed and the lower shales are more easily accessible. The cut section is as follows:

| | FEET. |
|--|-------|
| 6. Sandstone, soft, yellow to red, irregularly bedded. | 2 |
| 5. Clay, yellow, free from grit, much like geest..... | 1½ |
| 4. Limestone, brecciated, gray, with common Coal Measure fossils..... | 2 |
| 3. Shales, yellow, clayey..... | 8 |
| 2. Limestone, soft, sandy..... | ½ |
| 1. Shale, clayey, red to greenish..... | 12 |

Hamilton County.—Hamilton lies almost wholly within the area of the Coal Measures but few good outcrops are visible. Practically the only exposures appear along the Boone river between Webster City and the Webster county line, and these are almost wholly concealed by landslides and vegetation. No attempts have been made to explore or develop the shale clays. Some coal has been mined in this vicinity, but no mines are in operation today. The Silver mine, located on a small ravine west of the Boone river, (Tp. 88 N., R. XXVI W., Sec. 36, southeast quarter, southeast quarter) shows the following section:

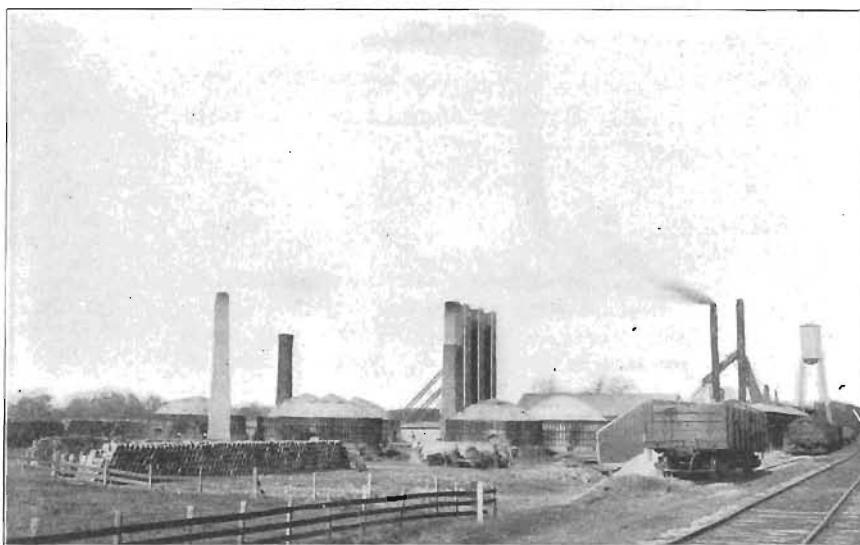

FIG. 49. Plant of Webster City Brick and Tile Company, Webster City, Iowa.

| | FEET. | INCHES. |
|--|-------|---------|
| 5. Drift | 2 | |
| 4. Shale, light to dark colored, somewhat sandy in places | 5 | |
| 3. Sandstone, massive, with occasional bands of bituminous shale | 3 | 4 |
| 2. Coal | 1 | 2 |
| 1. Shale, drab and fire clay (exposed)..... | 2 | |

The coal seam and fire clay band are visible at a number of points, but are not very accessible. There is no railroad, nor are there any towns in the vicinity of the outcrops.

Hardin County.—The Coal Measure shales have been developed at three points in the county; Iowa Falls, Eldora and Gifford; the first along the north fork of the Iowa river and the last two below the junction, and also on the bottom land of the South fork. Along the north fork of the Iowa river, from about a mile and one-half north of Gifford to some distance above Steamboat Rock, a red-brown sandstone appears prominently in the bluffs. In the vicinity of Eldora, clay shales appear in the valley walls. North of town along the Iowa river, on either side of the wagon road, two coal seams appear a few feet above the water in the river. The fire clay below the lower seam has a good reputation and was used formerly in the manufacture of pottery. East of Eldora, along on the east side of the river, the following section may be observed:

| | FEET. |
|--|-------|
| 5. Drift..... | 5-15 |
| 4. Sandstone, red, ferruginous | 30-40 |
| 3. Shales, variegated, fissile, oxidized to a yellowish-brown above but gray-blue to deep blue below. The variegated appearance is due in large measure to the seams and flattened lenses of fine, white sand..... | 12 |
| 2. Talus slope, beds concealed but probably made up of shales largely..... | 20-30 |
| 1. Sandstone, friable..... | 10-20 |

The beds are repeated west of the river; the sandstone, however, is much more prominent. The clay shales, number 3 in

the section, have been used to a limited extent by the clay plants in Eldora, but with results not altogether satisfactory, on account of the sand seams.

On the Iowa river bottom north of Eldora, a clay pit has been opened by the Eldora Pipe and Tile Company, who haul the clay to their plant in the city. A fair grade of fire clay is obtained in the vicinity, an analysis of which is given herewith.

| | |
|----------------------|-------|
| Silica..... | 72.09 |
| Alumina | 16.24 |
| Combined water | 5.18 |
| | <hr/> |
| Clay and sand | 93.51 |
| Iron oxide | 1.08 |
| Lime..... | 0.48 |
| Magnesia..... | 0.48 |
| Potash | 1.08 |
| Soda..... | 0.77 |
| | <hr/> |
| Total fluxes.... | 3.89 |
| Moisture | 2.46 |
| Sulfur trioxide..... | 0.14 |

Calculated on a water free basis, the total fluxes amount to scarcely more than four per cent, or more accurately, 4.36 per cent. The clay is highly plastic, shrinks but little during the processes of drying and burning, is excellently adapted to the manufacture of pottery, fancy and mottled brick, and would doubtless give a fair grade of fire brick when mixed with a liberal amount of "grog" and properly made.

High grade clays also occur south of Eldora, about one-half mile north of Gifford, on the bottom land of the south fork of the Iowa river. From two to four feet of stripping is required, below which is a section of nearly twenty feet of shale clays. These beds have been developed for some forty years, and are at present used by the Eldora Pipe and Tile Works and by the Marshalltown Pottery Company. Analyses of two of the types give the following results:

THE GEOLOGY OF CLAYS.

CLAY No. 1.

| | |
|---|-------|
| Silica..... | 78.49 |
| Alumina..... | 10.24 |
| Combined water..... | 3.33 |
| | <hr/> |
| Clay and sand..... | 92.06 |
| Iron oxide..... | 4.32 |
| Lime..... | .51 |
| Magnesia..... | .44 |
| Potash..... | 1.23 |
| Soda..... | .81 |
| | <hr/> |
| Total fluxes..... | 7.31 |
| Moisture, sulfur trioxide and carbon dioxide..... | .84 |

CLAY No. 2.

| | |
|---|-------|
| Silica..... | 63.27 |
| Alumina..... | 20.21 |
| Combined water..... | 8.50 |
| | <hr/> |
| Clay and sand..... | 91.98 |
| Iron oxide..... | 4.32 |
| Lime..... | .99 |
| Magnesia..... | .42 |
| Potash..... | .64 |
| Soda..... | .55 |
| | <hr/> |
| Total fluxes..... | 6.92 |
| Moisture, sulfur trioxide and carbon dioxide..... | .98 |

RATIONAL ANALYSES.

| | 1 | 2 |
|---------------------|--------|--------|
| Clay substance..... | 14.81 | 41.10 |
| Feldspar..... | 48.21 | 12.22 |
| Quartz..... | 36.98 | 46.68 |
| | <hr/> | <hr/> |
| | 100.00 | 100.00 |

Both clays are relatively low in fluxes and are highly plastic. Just south of the town of Gifford the Coal Measure shales outcrop along a small stream and have been developed by the Gifford Brick and Tile Works. The pit shows the following beds:

| | FEET. |
|---|-------|
| 2. Drift, on north side of pit arenaceous to gravelly below, loosely compacted dirty, yellow..... | 0-3 |
| On south side of pit a heavy, blue joint clay, oxidized a red brown along the joints..... | 0-3 |
| 2. Shale, deep blue (almost black when wet) considerably oxidized where unprotected by drift, becomes arenaceous eastward and contains but little iron..... | 8 |

The shale burns a pale red, works rather easily and makes a strong tile when properly burnt.

No other shale outcrops are known below this point within the limits of the county.

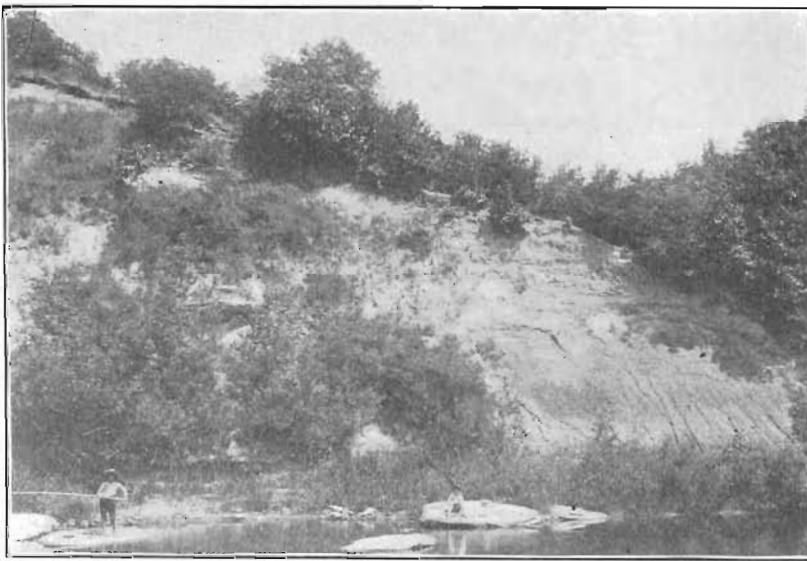

FIG. 50. "Honestone Quarries" showing Coal Measure shales on the Iowa river west of Iowa Falls, Iowa.

West of Iowa Falls the Coal Measures form two small detached areas along the Iowa river. Near the so-called "Honestone Quarries" the following beds may be viewed:

| | FEET. |
|---|-------|
| 7. Drift of variable thickness up to..... | 50 |
| 6. Shale, arenaceous..... | 10 |
| 5. Shale, sandy to shaly sandstone..... | 3 |
| 4. Shale, variegated, blue to yellow..... | 4 |
| 3. Sandstone, fine-grained, gray-blue, forming a projecting ledge | 2 |
| 2. Shale, fissile, gray-blue, to deep blue when wet.. | 30 |

UNCONFORMITY.

1. Limestone, cherty and much weathered, exposed.. 5-10

Near the streams which are tributary to the Iowa river, the drift covering is much thinner and the shales are much more accessible. These beds are being developed by the Iowa Falls Brick and Tile Company. A semi-fire clay appears in the section, from which a fair quality of fire brick is being manufactured. All of the clays run low in fluxes and are fused with difficulty.

Humboldt County.—The Coal Measures are believed to cover the southern portion of Humboldt county. Along the west fork of the Des Moines river, a short distance southwest of Bradgate, a white, arenaceous shale outcrops near the wagon bridge. The white shale is quite plastic when wet, and several feet of variegated shales rest upon it. The section continued upward consists of five feet of green, siliceous shale and, finally, twelve feet of gray plastic clay. Over this lies fourteen feet of gravel and yellow boulder clay. The major portion of the section is believed to be suitable for the manufacture of any of the common clay wares, and might possibly be suitable for sidewalk block and vitrified wares. None of the seams have been exploited.

Jasper County.—The Coal Measures cover almost the entire county, but shale outcrops are not very common, owing to the great thickness of the drift, especially in the northern and eastern portions, and consequent talus slopes. In the southern portion of the county the "Redreck" sandstone appears prominently along the stream ways. Two miles above Lynnville a coal shaft, known as the Black Oak shaft, penetrated the following beds:

| | FEET. |
|---|-------|
| 11. Drift..... | 5 |
| 10. Clay shale, light colored above, unctuous | 6 |
| 9. Coal..... | 4 |
| 8. Fire clay..... | 5 |
| 7. Sandstone, soft, massive, upper six inches indurated | 5 |
| 6. Shale, somewhat fissile, irregular concretionary bands of iron-stone at base..... | 20 |
| 5. Coal..... | 1¾ |
| 4. Fire clay | ¼ |
| 3. Shale, bituminous.... | 8 |
| 2. Coal..... | 1½ |
| 1. Fire clay, (exposed)..... | 2 |

The shale above the upper coal seam is quite persistent and could be mined readily with the coal. It has been tested, and gives a good quality of structural brick. It has not been developed, owing to lack of transportation facilities. Near the head of Birch creek, about one mile from the town of Monroe, the Coal Measures are being developed by the Monroe Brick and Tile Company.

Stoneware is also manufactured on a small scale. The pit section is as follows:

| | |
|---|-----|
| 5. Bowlder clay, occasionally lime bearing..... | 3½ |
| 4. Shale, strong, plastic, pink..... | 2 |
| 3. Shale, dark blue, plastic..... | 3½ |
| 2. Shale, bituminous, fissile..... | 2¼ |
| 1. Shale, white siliceous, in lower part..... | 10½ |

Number 1 has been used in the manufacture of pottery. The entire section, with the exception of number 5, can be utilized in the manufacture of common brick, hollow ware and probably vitrified brick.

Jefferson County.—The Coal Measures cover much the greater portion of the county. As the county has been considerably dissected by streams and the drift is comparatively thin, numerous shale sections are exposed, although shales are being utilized at but a single point, at Fairfield.

Near the southeast corner of the county, along a small ravine running into Cedar creek, on the southeast quarter of section 35, Round Prairie township, the following section may be observed:

| | FEET. |
|---|-------|
| 5. Shale, black..... | 12 |
| 4. Sandstone, white, with imbedded fragments of charcoal..... | 1½ |
| 3. Clay, arenaceous..... | 1 |
| 2. Shale, white, arenaceous..... | 3 |
| 1. Sandstone, white..... | 3 |

To the westward numerous good exposures of shales are visible along Cedar creek and small tributaries. Among the best of these may be mentioned the bluff on the south side of the creek on section 29, Cedar township, which shows the following beds:

| | FEET. |
|---|-------|
| 6. Sandstone, yellow..... | 3 |
| 5. Shale, yellow..... | 3 |
| 4. Coal of the common bituminous kind above, changing into cannel coal below..... | 1½ |
| 3. Fire clay..... | 3 |
| 2. Shale, dark, becoming highly carbonaceous and bituminous below..... | 6 |
| 1. Shale, green, extending down to the bed of the creek..... | 4 |

On the northwest quarter of section 32, in Fairfield township, the beds are decidedly more arenaceous and the sequence is as follows:

| | FEET. |
|--|-------|
| 7. Shale, soft, arenaceous with alternating bands of sandstone..... | 7 |
| 6. Sandstone, cross-bedded, somewhat coarse-textured..... | 10 |
| 5. Shale, gray, arenaceous, thinning toward the west. | 3 |
| 4. Sandstone, gray, slightly cross-bedded and micaceous..... | 7 |
| 3. Coal, thinning to the east and running out to the west, greatest thickness..... | 1½ |
| 2. Fire clay, gray and arenaceous..... | 3 |
| 1. Fire clay and shale (partly concealed)..... | 7 |

One-fourth of a mile south of the center of section 28 is located the clay pit of Raney Brothers Brick and Tile Plant. The pit section is as follows:



FIG. 51. Raney Brothers Brick and Tile Plant, Fairfield, Iowa.

| | FEET. |
|---|-------|
| 7. Loess and boulder clay | 15 |
| 6. Coal | ½ |
| 5. Fire clay, white | 2 |
| 4. Shale, black, with some crystals of gypsum | 3 |
| 3. Coal | 1 |
| 2. Fire clay, white | 4 |
| 1. Sandstone, greenish, fine-grained, micaceous | 1 |

Exposures similar to the pit section continue along the small creek. In Liberty township sections are common along Cedar creek. A good exposure may be viewed in the north bluff east of the wagon bridge in section 3, and shows the following beds:

| | FEET. |
|--|-------|
| 7. Shale, gray, disintegrated and containing crystals of gypsum, and a calcareous seam which bears fossils and concretions | 25 |
| 6. Coal | 1 |
| 5. Sandstone, brown | 1-5 |
| 4. Shale, black | 1 |
| 3. Coal | 1 |
| 2. Fire clay and shale | 10 |
| 1. Coal, partially concealed near bed of creek | 2 |

A generalized section of the Coal Measures for Liberty township would be as follows:

| | FEET. |
|---------------------------------|-------|
| 9. Concretionary limestone..... | 1-5 |
| 8. Shale, gray..... | 5 |
| 7. Coal..... | 0-3 |
| 6. Fire clay..... | 0-4 |
| 5. Sandstone, hard, gray..... | 0-5 |
| 4. Shale..... | 30 |
| 3. Shale bituminous..... | 1-3 |
| 2. Coal..... | 3 |
| 1. Fire clay, and shale..... | 7 |

The preponderance of shales in the above section is obvious, and yet none are being utilized in clay manufactures.

In the western tier of townships, shale exposures are still common. On the west bank of Competine creek, in the southeast quarter of section 21, in Locust Grove township, a representative section may be seen. The sequence is as follows:

| | FEET. |
|---|-------|
| 5. Shale, bituminous..... | 1 |
| 4. Shale, sandy, greenish, in places dark and with septarian nodules..... | 15 |
| 3. Sandstone, argillaceous, greenish and calcareous.. | ½- 1 |
| 2. Shale, arenaceous, green..... | 8-10 |
| 1. Limestone, brecciated, concretionary..... | 3 |

Jefferson county possesses good railway facilities, and doubtless the shale clays which are more than ordinarily accessible will receive, at some future time, the attention their importance merits.

Keokuk County.—The Pleistocene deposits cover the entire county and attain an unusual thickness, averaging from 100 to 200 feet over the uplands. Only the larger streams have cut through the drift, exposing the older rocks. The Coal Measures occupy the greater portions of Prairie and Washington townships, and a number of isolated patches occur over the southern half of the county. Along Coal creek, in the vicinity of What Cheer, unimportant crops of shales appear, but are usually much obscured by drift-slides. The principal coal horizons are usually

accompanied by important fire clay seams. One of these has been tested for pottery, and the results were all that could be desired. None of the beds, however, have been exploited commercially. Extensive development of the shales and clays could only be done by using mining methods.

The fire clay which accompanies the principal coal seams of the What Cheer district has been analyzed, and the results are as follows:

| | |
|----------------------|-------|
| Silica..... | 62.75 |
| Alumina..... | 22.00 |
| Combined water..... | 6.92 |
| <hr/> | |
| Clay and sand..... | 91.67 |
| Iron oxide..... | 2.28 |
| Lime..... | 0.65 |
| Magnesia..... | 0.39 |
| Potash..... | 1.93 |
| Soda..... | 1.49 |
| <hr/> | |
| Total fluxes..... | 6.74 |
| Moisture..... | 0.84 |
| Sulfur trioxide..... | 0.69 |

RATIONAL ANALYSIS.

| | |
|---------------------|--------|
| Clay substance..... | 40.11 |
| Feldspar..... | 5.52 |
| Quartz..... | 54.37 |
| <hr/> | |
| | 100.00 |

The fluxes run low, and the clay is highly plastic. It burns a light buff and requires more than 2,800 degrees Fahrenheit to fuse it.

Near Delta the glacial debris is somewhat thinner. About one mile and a quarter southeast of town, a shaft sunk by Martin Fisher penetrated the following beds:

| | FEET. |
|---------------------------------|-------|
| 5. Drift..... | 4 |
| 4. Shale, bituminous below..... | 9 |
| 3. Coal..... | 41½ |
| 2. Fire clay..... | 41½ |
| 1. Shale, bituminous..... | |

A small Coal Measure outlier about two and one-half miles north of Martinsburg furnishes a fair grade of clay which has been used to a limited extent by the local brick and tile plants in admixture with the surface clays. Other small outliers would furnish, doubtless, good material for the various grades of clay wares, but no attempts have been made as yet to utilize them.

Lee County.—Several more or less detached Coal Measure outliers form the country rock in the northern and western portions of the county. In Franklin township some coal has been mined. On the northeast quarter of the northeast quarter of section 4, the old Hardwick mine and slope along Sugar creek show the following section:

| | FEET. |
|-------------------------------------|-------|
| 5. Drift..... | 3 |
| 4. Shale, bituminous..... | 1 |
| 3. Coal..... | 3½ |
| 2. Fire clay, arenaceous..... | 2 |
| 1. Shale, arenaceous (exposed)..... | 3 |

On the northwest quarter of section 10, in the same township, a more extensive outcrop is exposed. The following beds come into view, the upper beds, only, belonging to the Coal Measures:

| | FEET. |
|---|-------|
| 7. Drift..... | 10 |
| 6. Coal..... | 2 |
| 5. Fire clay..... | 2 |
| 4. Sandstone, soft, quartzose..... | 5 |
| 3. Limestone, coarse, irregular..... | 2 |
| 2. Shale, calcareous..... | 1 |
| 1. Limestone, shaly above to sandy below..... | 11 |

North of Keokuk, near Rand Park, some exploratory work for coal has been done. The section is as follows:

| | FEET. |
|--|-------|
| 6. Drift..... | 20 |
| 5. Shale, dark, bituminous..... | 6 |
| 4. Coal..... | 1½ |
| 3. Fire clay..... | ½ |
| 2. Sandstone, brown, coarse-grained..... | 10 |
| 1. Limestone, brecciated (exposed)..... | 8 |

Below Keokuk, above Nassau slough, shale beds appear but they have not been developed. Clays and shales are available at other points, but as yet but feeble attempts have been made toward their utilization. In many instances sufficient coal is found in the immediate locality to burn the clays.

Lucas County.—Although the county lies well within the Coal Measure area, good sections are rare, on account of the generous drift covering and absence of large streams. The shale clays have not been developed within the confines of the county. The best exposures occur on the Chariton river, Whitebreast creek and along the Little Whitebreast and its tributaries in the vicinity of Chariton and Cleveland. Five miles northeast of Cleveland, the bluff section along Whitebreast creek is as follows:

| | FEET. |
|---|-------|
| 12. Drift..... | 5 |
| 11. Shale, argillaceous, variegated..... | 4 |
| 10. Coal..... | 1½ |
| 9. Fire clay..... | 1 |
| 8. Shale, variegated..... | 8 |
| 7. Limestone, impure, earthy in places..... | 2 |
| 6. Shale, ash colored, calcareous below..... | 6 |
| 5. Limestone, bluish, nodular in places..... | 2 |
| 4. Shale, black, bituminous, fissile..... | 1½ |
| 3. Coal..... | 1½ |
| 2. Fire clay..... | 2 |
| 1. Shale, light colored, sandy in places..... | |

Here, as elsewhere in the county, wherever the Coal Measures are exposed the shales and clays are greatly in the predominance and most of them are suitable singly or in combination for the manufacture of the various grades of clay wares.

Madison County.—The upper Coal Measures occupy a considerable portion of the county. The margin is deeply lobular, owing to profound stream dissection. The lower Coal Measures form the country rock over the northeast quarter of the county and follow the more important stream ways well toward the western and southern boundaries of the county. Good exposures are common and easily accessible; the best for the lower

Coal Measures may be observed in South township. The most complete section occurs on a small branch of Chariton creek, which takes a west and north course across sections 35, 34 and 27. The section heads near the Des Moines and Kansas City railroad, while the base of the section reaches almost to the right-of-way of the Chicago Great Western railroad. The sequence is as follows:

| | FEET. | INCHES. |
|---|-------|---------|
| 22. Shales, drab, argillaceous | 12 | |
| 21. Shales, red, argillaceous..... | 3 | |
| 20. Limestone, fragmental, earthy, with bits of fossils..... | | 2 |
| 19. Shales, blue to green, argillaceous, grading into red below..... | 3 | |
| 18. Shales, blue to green, sandy, with nodular segregations of limestone..... | 12 | |
| 17. Shales, blue, calcareous..... | 12 | |
| 16. Limestone, compact..... | | 2 |
| 15. Limestone, fragmental, loose | | 10 |
| 14. Limestone, fragmental, but firmly cemented, reddish color..... | 1 | |
| 13. Shales, green, argillaceous..... | 29 | |
| 12. Limestone, blue to black, in two ledges..... | 1 | |
| 11. Shale, carbonaceous..... | 2 | |
| 10. Shale, clayey, drab..... | 1 | |
| 9. Shale, yellow, sandy, with marked horizontal bedding planes..... | 4 | |
| 8. Shales, black to drab, carbonaceous..... | | 6 |
| 7. Limestone, nodular, sandy..... | 1 | 4 |
| 6. Shale, gray, sandy..... | 3 | |
| 5. Limestone, similar to No. 7..... | | 10 |
| 4. Shale, clayey, drab to blue..... | | 10 |
| 3. Shale, carbonaceous..... | 1 | |
| 2. Limestone, thin bedded, leaf-like in texture.. | | 3 |
| 1. Clay, green..... | 3 | |

North of St. Charles, on the road leading south across section 11, the following beds are exposed along a gully. The section starts 100 feet below the upland.

| | FEET. | INCHES. |
|--|-------|---------|
| 15. Drift..... | 6 | |
| 14. Sandstone, soft, gray, with flakes of yellow mica..... | 8 | |
| 13. Shales, sandy, gray..... | 15 | |

| | FEET. | INCHES. |
|--|-------|---------|
| 12. Limestone, sandy, fossiliferous | 1 | 2 |
| 11. Shales, carbonaceous, coaly below..... | 1 | 4 |
| 10. Shales, gray..... | 4 | |
| 9. Sandstone, heavily bedded, with Lepidondendrons | 4 | |
| 8. Shale, sandy above..... | 6 | |
| 7. Coal | | 6 |
| 6. Shales, clayey, variegated..... | 20 | |
| 5. Shales, bituminous | 2 | |
| 4. Limestone, fragmentary..... | 5 | |
| 3. Shales, blue to gray..... | 6 | |
| 2. Shales, carbonaceous..... | 2 | |
| 1. Shales, blue, clayey, exposed. | 5 | |

One of the most important sections of clay shales exposed in the county may be viewed on the south bank of the Middle river, about two miles southwest of Bevington. The indurated beds exposed are as follows:

| | FEET |
|--|------|
| 11. Limestone, weathered, clayey..... | 2 |
| 10. Shale, gray and drab in color | 2 |
| 9. Shale, yellowish-gray, grading into bituminous below..... | 2½ |
| 8. Coal, decomposed..... | ½ |
| 7. Fire clay more or less impure..... | 4 |
| 6. Shale, yellow to gray, sandy, somewhat ferruginous | 12 |
| 5. Shale, red, siliceous, fissile..... | 3 |
| 4. Sandstone, micaceous | 1 |
| 3. Shale, similar to No. 6 | 7 |
| 2. Shale, down to the river. | 15 |
| 1. Coal | 1½ |

Similar beds occur along Jones creek westward from Hawley. At Winterset the shales are less important, limestone becoming the most prominent member in the series and is extensively quarried.

South of Patterson an exposure along a ravine in section 32, northwest quarter of southeast quarter, in Crawford township, yields the following section:

| | FEET. | INCHES. |
|---|-------|---------|
| 14. Shale, black | 2 | |
| 13. Unexposed, probably shales..... | 21 | |
| 12. Shale, blue, clayey above, gray, sandy below | 16 | |
| 11. Limestone, dense, drab, fossiliferous | 1 | |
| 10. Shale, blue, clayey..... | 3 | |
| 9. Sandstone, gray..... | | 5 |
| 8. Shale, clayey, blue and gray | 27 | |
| 7. Sandstone, gray, nodular..... | 1 | |
| 6. Shale, sandy, drab..... | 27 | |
| 5. Limestone, arenaceous, gray, fossiliferous..... | | 9 |
| 4. Shale, black | 2 | |
| 3. Shale, gray, clayey (only partly exposed) .. | 30 | |
| 2. Coal | | 6 |
| 1. Shale, red (only partly exposed)..... | 32 | |

In addition to these sections, numerous other outcrops are visible, but the above are the best and are believed to be fairly representative of the lower Coal Measure series. It is obvious from a casual inspection of the sections that shales are in great predominance, and shales of the light colored, argillaceous type. The beds are easily accessible and could be reached readily by the extension of railway spurs. Yet no exploratory nor development work has been done with a view to using the shale clays.

Shales are not so conspicuous in the upper Coal Measure portion of the county. Beds accessible and of sufficient extent to be important economically could be found, doubtless, if sought, but no efforts have been made in that direction.

Mahaska County.—The Coal Measure beds underlie the superficial materials over nearly the whole county and consist largely of shales. The larger streams uncover the indurated rocks and render the shales accessible. The sections are obscured very largely, however, by the glacial debris. In the southwestern part of the county, shaft No. 8 of the Consolidation Coal Company may be considered a type section for the district. The shaft is located on the divide between the Des Moines river and Muchakinoek creek, section 34, Des Moines township. The section is as follows:

| | FEET. |
|---|-------|
| 8. Drift..... | 18 |
| 7. Shale, gray, argillaceous..... | 32 |
| 6. Coal..... | 1½ |
| 5. Sandstone..... | 4 |
| 4. Shale, bituminous..... | 49 |
| 3. Coal..... | 7 |
| 2. Fire clay grading into gray shale..... | 35 |
| 1. Limestone (Saint Louis)..... | — |

Usually the drift is so thick on the divides that open pit work is impossible; the shales could be developed only through mining. Numerous outcrops along Muchakinoek creek display a wide assortment of shale clays, none of which have been utilized. The only point in the county where the shales are utilized is at Oskaloosa. The pit of the Oskaloosa Paving Brick Company shows the following beds:

| | FEET. |
|--|---------|
| 5. Drift, largely altered loess with some gneiss pebbles and a few large bowlders disseminated in it.... | 20 |
| 4. Shale, blue, makes a good brick but does not stand the frost as well as the bottom clay..... | 10 |
| 3. Shale, very bituminous..... | 2 |
| 2. Coal, good quality, apparently the attenuated edge of a four-foot seam formerly worked in the southern slope of the same ridge..... | 1½ to 2 |
| 1. Shale, gray, homogeneous except for thin lines of coal and occasional pyrite balls. Plant remains abundant..... | 30 |

Numbers 1 and 4 are blended and the resultant mixture, when properly burned, yields a good quality of paving brick as well as builders and face brick. The fire clay below the coal seam burns a buff color, and when made into brick by the dry press process, gives a superior face brick. Some experimental work has been done in the manufacture of mottled face brick and floor tile, with good success. For ordinary builders, some of the loess may be added without harm to the product. No analyses of the clay or tests of the ware have been made.

The Coal Measure shales appear west of town, one of the best sections being exposed on an extension of Third street, about one-half mile beyond the city limits. The following beds may be here observed:

| | FEET. |
|-------------------------------|-------|
| 6. Soil..... | 2 |
| 5. Gravel, fine..... | 2 |
| 4. Clay, yellow, jointed..... | 12 |
| 3. Shale, clayey, blue..... | 10 |
| 2. Coal..... | 3 |
| 1. Fire clay, exposed..... | — |

A number of years ago, numbers 3 and 4 were used in the manufacture of common brick. Number 1 is used to a limited extent at the present time at a small factory west of the old Guthrie yard. The Coal Measure clay is mixed with the surface soil and manufactured into common soft mud brick.

Most of the fire clays which accompany the principal coal seams are of economic importance, and one or two were used to some extent a few years ago in the manufacture of pottery. No pottery is made within the limits of the county at present.

Marion County.—The Coal Measures cover the entire county with the exception of narrow areas along the principal waterways in the eastern part of the county, where they have been removed through erosion. Shales and clays are less predominant here than in most of the Coal Measure counties. The “Red Rock” sandstone assumes considerable importance and gives character to the topographic features along the Des Moines river. Good shale sections are not common. Along Whitebreast creek some of the most extensive outcrops may be observed, but they are far removed from railway lines at present. In the northeast quarter of section 4, in Dallas township, the following beds occur:

| | FREET. | INCHES. |
|--|--------|---------|
| 11. Loess and drift..... | 10 | |
| 10. Shale, yellow, argillaceous..... | 5 | |
| 9. Shale, bituminous..... | 3 | |
| 8. Coal, very soft..... | 1 | 2 |
| 7. Fire clay..... | 2 | 3 |
| 6. Coal..... | | 4 |
| 5. Fire clay..... | 2 | 6 |
| 4. Sandstone, thinly laminated, white..... | 1 | |
| 3. Sandstone, massive, buff..... | 4 | |
| 2. Shale, gray, arenaceous..... | 3 | |
| 1. Shale, bituminous (exposed)..... | 10 | |

Other exposures appear on Whitebreast creek. One of the best occurs about four miles to the northeast, in the southeast quarter of section 19, in Knoxville township. The section is as follows:

| | FREET. | INCHES. |
|--|--------|---------|
| 9. Clay, yellow, derived from decayed shale..... | 5 | |
| 8. Shale, bituminous..... | 5 | |
| 7. Coal, very soft..... | 1 | 6 |
| 6. Fire clay, arenaceous, extremely hard, much fractured and filled with root casts..... | 2 | |
| 5. Sandstone, gray, thinly laminated above and massive below..... | 12 | |
| 4. Shale, arenaceous..... | 1 | 4 |
| 3. Sandstone, gray, soft..... | 2 | 6 |
| 2. Shale, arenaceous..... | 5 | 9 |
| 1. Sandstone, massive, buff to gray, irregu- larly cross-bedded, exposed to water | 25 | |

Farther east and south, the sandstone members become much more important, although certain beds of shale persist and doubtless are thick enough to merit consideration. Along Coal creek, in Pleasant Grove township, the Coal Measures are quite well exposed; the following section may be taken as a fair sample. (Northwest quarter, northeast quarter of section 20.)

| | FREET. |
|---|--------|
| 8. Surface waste..... | 5 |
| 7. Coal..... | 1½ |
| 6. Fire clay..... | 2 |
| 5. Shale, light, argillaceous..... | 2½ |
| 4. Shale, drab, arenaceous..... | 5½ |
| 3. Sandstone, gray, thinly laminated usually, massive in places..... | 3 |
| 2. Shale, gray, arenaceous..... | 3 |
| 1. Shale, bituminous, exposed to water..... | 13 |

A workable coal seam lies but a few feet below the stream bed. Here, as in other coal counties, fire clays of workable thickness accompany the coal seams and could be mined readily.

Monroe County.—The stratified shale clays of the Coal Measures cover almost the entire county, although they are only exposed along the stream ways. The most accessible sections appear in the northeast half of the county. Almost every ravine in the vicinity of Buxton and Hiteman exhibits liberal sections of argillaceous beds above the water line and are not deeply covered by surface materials. Shales appear lower in the valley walls along Coal and Cedar creeks and their tributaries, and the streams draining east from the divide. Many of the exposures are located directly on railroad lines, or within easy reach of such lines. Near the center of the northwest quarter of section 8, Pleasant township, an excellent section of shale clays is exposed which may be considered fairly representative for the district. The sequence is as follows:

| | FEET. |
|------------------------|-------|
| 7. Drift, exposed..... | 5 |
| 6. Shale, clayey..... | 10 |
| 5. Coal..... | 1 |
| 4. Clay..... | 2½ |
| 3. Sandstone..... | 3 |
| 2. Shale..... | 35 |
| 1. Coal..... | 4 |

With the exception of the drift, which contains considerable calcareous matter, and the coal **seams**, the entire assemblage of beds could be utilized. Here, as **elsewhere**, the drift has greatly obscured natural sections, but **systematic** prospecting would undoubtedly show **the presence** of an abundance of suitable material near the railroads. In Bluff Creek township, at the point where the Chicago & Northwestern **railroad** crosses the creek in section 5, shale beds may be observed as follows:

| | FEET. |
|---------------|-------|
| 3. Shale..... | 4 |
| 2. Coal..... | 5 |
| 1. Shale..... | 10 |



PLATE XXI. Section on Gray creek, Pleasant township, Monroe county. More than fifty feet of shales are exposed here.

The drift at this point is of variable thickness, usually not great. Coal is easy of access, and could be produced cheaply for burning the product. Nearly all of the ravines and small tributaries in this vicinity exhibit clays and shales suitable for manufacturing purposes, and many of the exposures are easily accessible and could be developed cheaply. One of the prospect holes put down by the Consolidation Coal Company gives a fair idea of the wealth of shales and clays available.

Tp. 73 N., R. XVII W., Sec. 17, Ne. qr., Ne. $\frac{1}{4}$.

| | FEET. |
|---|----------------|
| 11. Drift and surface wash..... | 9 |
| 10. Clay, shale, unctuous..... | 16 |
| 9. Shale, black, somewhat bituminous..... | 5 |
| 8. Coal..... | $\frac{1}{2}$ |
| 7. Sandstone, friable..... | 10 |
| 6. Shale, argillaceous..... | 79 |
| 5. Coal..... | $1\frac{1}{2}$ |
| 4. Sandstone..... | $2\frac{1}{2}$ |
| 3. Shale..... | 45 |
| 2. Shale, bituminous, bowldery..... | 6 |
| 1. Coal, impure above..... | $4\frac{1}{2}$ |

In Guilford township the Wapello Coal Company has done considerable prospecting with the core drill. On the upland the drift is prevailingly thick, but on the lowlands, or second bottom lands, the drift has been removed in large part and the shales and clays are within easy working range. A drill hole put down in the northeast quarter of the southwest quarter of section 12 may be considered typical for the vicinity. The sequence of beds penetrated is as follows:

| | FEET. |
|------------------------------------|-----------------|
| 12. Drift and surface wash..... | 17 |
| 11. Shale, clayey..... | 16 |
| 10. Coal..... | $1\frac{1}{2}$ |
| 9. Fire clay, impure..... | $7\frac{1}{2}$ |
| 8. Sandstone..... | 12 |
| 7. Shale, somewhat bituminous..... | $5\frac{1}{2}$ |
| 6. Coal..... | $3\frac{1}{2}$ |
| 5. Sandstone..... | $5\frac{1}{2}$ |
| 4. Shale, blue black..... | 6 |
| 3. Sandstone..... | 22 |
| 2. Shale, bituminous below..... | $44\frac{1}{2}$ |
| 1. Coal..... | $5\frac{1}{2}$ |

In the vicinity of Hocking, in Troy township, the Coal Measures are more arenaceous in character; at least, the arenaceous beds predominate in the outcrops exposed along the small streams. West of Hocking, the outcrops along Cedar creek paralleled by the Chicago, Burlington and Quincy railway, are prevailingly arenaceous in character, although accompanied by important shale seams. In the eastern portion of the county, along Soap creek and the Averies, shale crops are common, but no very extensive beds are known. Most of the outcrops are greatly obscured by the heavy drift talus and vegetation. No systematic prospecting has been done in the county for shales and clays, and no serious attempt has been made toward their utilization. By far the largest amount of clay wares consumed are imported, notwithstanding the fact that Monroe county possesses unsurpassed facilities in the way of an abundance of excellent raw materials and cheap fuel.

Montgomery County.—Thick beds of Coal Measure shales are known to exist over the northeast corner of the county, but owing to the thickness of the drift covering they are not very accessible. Their availability is seriously impaired, also, on account of the absence of good railway facilities in that portion of the county. The limestone members in the upper Coal Measures here, as in other counties in southwestern Iowa, are quite strongly developed, while the shales are much less important than in the counties farther east. The shales which do occur are often calcareous or carry calcareous concretions, both of which seriously impair their usefulness for clay working. The section exposed in the Fate quarry, at Stennett, gives a good idea of the upper Coal Measures as they are developed in the county. The details of the section are shown in the accompanying figure and are as follows:

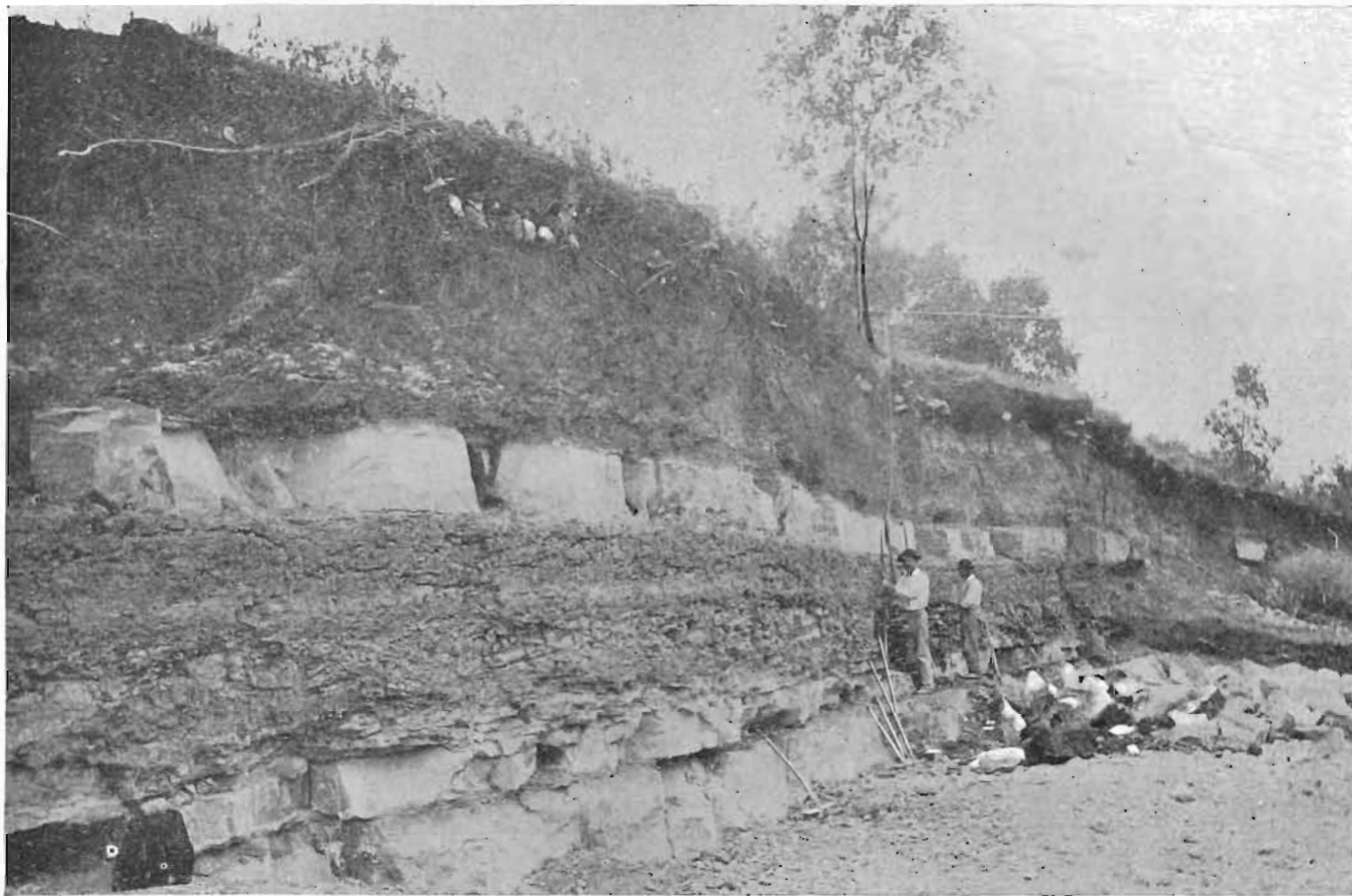

PLATE XXII. Representative section of the upper Coal Measures as exposed at Stennett, Montgomery county, Iowa.

| | FEET. | INCHES. |
|--|-------|---------|
| 10. Limestone, residual. | 5 | 6 |
| 9. Shale, calcareous..... | | 6 |
| 8. Limestone, gray, fine-textured | 1 | 7 |
| 7. Shale, buff to gray, argillaceous..... | 3 | 4 |
| 6. Limestone, variable, earthy below | 5 | |
| 5. Clay, buff | 1 | |
| 4. Limestone, blue above, cherty..... | 6 | |
| 3. Shale..... | | 2 |
| 2. Limestone, variable..... | 5 | |
| 1. Shale..... | 1 | 6 |

Numbers 1 to 5 are not exposed in the figure. At Villisca the limestone beds are less prominent. Just south of town the Villisca Brick and Tile Company have opened a pit in which limestones are absent. The section is as follows:

| | FEET. |
|---|-------|
| 5. Loess, yellow to brown or gray, jointed in upper part..... | 12 |
| 4. Sand, clean; thickness varies from one inch to | 2 |
| 3. Shale, argillaceous, dark gray to green in color | 4 |
| 2. Shale, argillaceous, light gray | 3 |
| 1. Shale, gray to light, rather finely siliceous..... | |

Number 3 is of good quality; number 2 contains thin shells and crinoid stems in considerable abundance, but is usable. Number 1 is from twenty to sixty feet in thickness as determined by borings, but is imperfectly exposed at the pit. It can be used when mingled with some of the beds above, but is too siliceous to be used satisfactorily alone. This is the only point in the county where the Coal Measure shales are being developed.

Muscatine County.—The Coal Measures occupy a considerable portion of Montpelier, Sweetland and Bloomington townships. This basin extends into Scott county, following the great bend of the Mississippi river. The series of beds as they are developed in this basin are very variable. A thin seam of coal appears at a number of points and is usually accompanied by an important bed of fire clay which has been developed to some extent by the local potteries at Fairport. In section 30 of Sweetland township, the series is essentially made up of shales. The old Hoop

coal bank in the east half of the section is reported to have shown the following beds:

| | FEET. |
|--------------------------------------|-------|
| 5. Shale, bluish, argillaceous | 10 |
| 4. Sandstone, rather compact..... | 2 |
| 3. Coal | 3 |
| 2. Fire clay, soft, gray | 4 |
| 1. Concealed to the river..... | 30 |

Some of the clay used by the potteries is obtained from the Illinois side. A portion is secured along Pine creek and from a pit along a small stream north of Fairport. Only the commoner varieties of pottery are attempted. The results are satisfactory, but operations are carried on on a small scale.

The Coal Measure shales present limited exposures at Muscatine. One of the best is known as the Powder House Clay Pit, and is situated above the track about one-half mile east of the river bridge. The sequence of beds is as follows:

| | FEET. |
|---|-------|
| 4. Shale, hard, gray, impure. | 2 |
| 3. Coal, decomposed, soft | 1½ |
| 2. Shale, dark gray, siliceous..... | ½ |
| 1. Shale, light gray, slightly sandy..... | 4 |

Number 1 has been used to some extent by the local potteries. It bears some iron oxide in seams, otherwise it is nearly free from impurities. The drift rests unconformably upon the Coal Measures and is covered with loess. At Butlerville, about two miles northwest of Muscatine, an argillaceous shale appears. It is gray to blue in color, fairly plastic, but lacks "body" and crumbles under high temperatures. It is reported about six feet in thickness and rests on sandstone. It could doubtless be blended with some of the surface clays and used satisfactorily in the manufacture of hollow ware. A good section of shales was formerly developed at Montpelier. It is located about one-half mile north of town. The sequence is as follows:

| | FEET. |
|---|----------------|
| 13. Drift, lime bearing..... | 3 |
| 12. Shale, light blue, darker below | 10 |
| 11. Limestone, impure, ferruginous... .. | $\frac{5}{8}$ |
| 10. Shale, impure, pyritiferous | 3 |
| 9. Coal, sandy and pyritiferous | $1\frac{3}{8}$ |
| 8. Shale, finely siliceous, gray | 17 |
| 7. Sandstone, fine-grained..... | $1\frac{1}{2}$ |
| 6. Shale, bituminous | $\frac{3}{8}$ |
| 5. Coal, rather pure | $2\frac{1}{2}$ |
| 4. Shale, dark gray, in part impure | 5 |
| 3. Shale, black | $\frac{5}{8}$ |
| 2. Coal | 3 |
| 1. Sandstone. | $7\frac{1}{2}$ |

The lower four members are not visible, but have been explored by drilling. Number 12, only, has been used in clay manufacturing. It is of good quality, fairly pure, containing occasional sulfur balls which could be readily removed. The other shale members could be used by blending with number 12, but no attempts have been made in that direction. The beds dip southeastward, and at the present time the plant is not in operation.

Page County.—With the exception of a few small and undefined patches of Cretaceous sandstone, the rocks beneath the drift belong to the Carboniferous system and to the upper Coal Measures, or Missourian stage. These strata consist of limestones and shales, the shales predominating as to thickness, but the limestone appearing in the greater number of exposures, owing to their greater powers of resistance. The shales and limestones found in Page county occupy a position from 500 to 600 feet above the Bethany or Winterset limestones that lie at the base of the upper Coal Measures. There are two limestone horizons in the county, one represented by the exposures at Hawleyville and Bradyville, and the other by the ledges outcropping in the valley of the East Tarkio. These limestones are separated by more than 100 feet of shale. Shales similar to these are manufactured on a large scale into paving and structural brick, at Nebraska City, Nebraska, and they are used extensively in brick

making at Villisca. They have not yet been developed in the county. The shales above the Tarkio limestone are usually calcareous to marly and perhaps would not prove very satisfactory in the clay industries unless carefully selected.

The shales between the limestone are not well shown in the county, but an excellent section is exposed near Burlington Junction, in Missouri, from which a good idea of their nature and thickness may be gained.

| | FEET. | INCHES |
|--|-------|--------|
| 20. Shale, blue | 10 | |
| 19. Shale, yellowish-green, calcareous | | 3 |
| 18. Shale, marly, concretionary..... | 2 | |
| 17. Shale, bluish-green, not calcareous .. | 3 | |
| 16. Shale, yellowish, calcareous, concretionary . | 1 | 6 |
| 15. Shale, greenish-blue | 1 | |
| 14. Sandstone, calcareous, ferruginous | | 6 |
| 13. Shale, sandy, with septarian nodules in the upper part..... | 10 | |
| 12. Limestone, impure, with obscure impressions of fossils..... | | 2 |
| 11. Shale, sandy | 2 | |
| 10. Limestone, impure, in thin bands alternating with sandy shale which carries septarian nodules near the bottom, fossiliferous ... | 5 | |
| 9. Shale, gray..... | 3 | |
| 8. Thin layer showing cone-in-cone at top and bottom, structureless in the middle.... | | 7 |
| 7. Shale, gray with occasional large septarian nodules | 25 | |
| 6. Calcareous band, fossiliferous..... | | 4 |
| 5. Shale, dark, with some calcareous bands, fossiliferous near top, down to level of water in river | 25 | |
| 4. Shale, below level of river | 30 | |
| 3. Cap-rock | 2 | |
| 2. Shale | 4 | |
| 1. Coal (Nodaway)..... | 1 | 6 |

The colors in the above section have been modified somewhat by weathering, the yellows would be replaced, doubtless by grays and blues in protected sections. The shales above the Tarkio limestone are not well shown in the county.

Polk County.—Polk county is centrally located in the lower Coal Measure district of the state, and in this county the shales have received most attention. Des Moines, located south of the center of the county, is the greatest clay manufacturing city in the state, and one of the greatest west of the Mississippi river, and bids fair to hold her well earned premiership as a clay working center. The industry is yet scarcely past its infancy. The presence, in the immediate vicinity, of almost inexhaustible quantities of clays and shales, with countless possibilities as to manufactured products, and easily accessible, with coal at hand, unrivalled transportation facilities, and ever increasing demand for clay goods, the industry may confidently be expected to make rapid progress until it becomes the leading manufacturing industry in the city. The generalized section of the Coal Measures for Des Moines, according to Bain,* is as follows:

| | FEET. | INCHES. |
|---|-------|---------|
| 18. Variegated clay shales | 13 | |
| 17. Limestone, blue, nodular, weathering brown, fossiliferous | 0 | 8 |
| 16. Shales, variegated..... | 8 | |
| 15. Shales, bituminous, with calcareous con- cretionary masses below, fossil bearing. | 3 | |
| 14. Coal..... | 2 | |
| 13. Shale, light yellow and drab | 7 | |
| 12. Clay shale, variegated..... | 4 | |
| 11. Limestone..... | 0 | 8 |
| 10. Shales, variegated, clayey..... | 4 | |
| 9. Limestone, nodular, earthy, passing in places into marl, highly fossiliferous..... | | 6 |
| 8. Clay shale, light colored..... | 5 | |
| 7. Sandstone, soft, micaceous, becoming in places an arenaceous shale..... | 20 | |
| 6. Shale, clayey, gray, yellow and red in color | 8 | |
| 5. Sandstone, grayish, soft | 4 | |
| 4. Coal, impure, divided in places into three thin seams, which vary considerably in thickness..... | 2 | |
| 3. Shale, light gray, fissile..... | 5 | |
| 2. Shale, light to dark gray, micaceous below bituminous above | 6 | |
| 1. Shale, white, siliceous | 10 | |

* Geology of Polk county, Geology of Iowa, Vol. VII, pp. 292 and 293.

Numbers 1 to 7, inclusive, are shown at the pit of the Iowa Pipe and Tile Company, east of the river; numbers 7 to 12 are exposed at the south end of Capitol Hill; numbers 12 to 18 are shown in street cuttings and clay pits in the northwestern portion of the city. It is obvious from the above sections that the shales greatly predominate. They vary greatly in composition, texture and adaptabilities. They are used for the manufacture of the various grades of building and paving brick, sewer pipe, conduits and drain tile, and have been used for common pottery. Certain seams are believed to possess the requisite properties to adapt them to the manufacture of terra cotta, mottled and fancy brick, floor tile and enameled ware. The shale clays have been developed at numerous points in and about the city of Des Moines, and the great variety of shades and grades, with their adaptabilities, can best be brought out by a consideration of the individual pits. At no other place in the state have the clays and their manufactured products been so thoroughly studied and tested.

The Des Moines Brick Manufacturing Company.—This company was the pioneer in the paving brick industry of Des Moines and the state. At one time it was the most extensive plant in the state, but in 1899 a fire destroyed the principal buildings, which have never been restored, and the plant has been dismantled. The clay pit section is included here because it is believed that the beds are available further west, and because elaborate tests have been made of the raw materials. The pit is located along the tracks of the Chicago, Rock Island and Pacific railway and the Spirit Lake branch of the Chicago, Milwaukee and St. Paul, and shows the following beds under a thin veneer of drift:

| | FEET. |
|--|-------|
| 8. Clay, variegated, highly refractory, burning to a brick of medium toughness, high porosity and low breaking strength; thickness, three to eight feet, average | 5 |

| | FEET. |
|--|----------|
| 7. Shale, streaked in color, medium fusibility, high in iron and fluxes; burns to a brick of medium toughness, medium porosity and low resistance to rupture; thickness, three to eight feet, average..... | 4 |
| 6. Shale, solid chocolate, brown color, clear definition; brick show medium toughness, low porosity and high modulus of rupture | 5 |
| 5. Shale, solid color, clear to poor definition, an average clay with medium iron and fluxes, lower than the clays above; bricks show low toughness, low porosity, high modulus of rupture.... | 5 |
| 4. Shale, variegated clear to poor definition, low in iron and fluxes, high alumina, bricks show medium toughness, low absorption, high modulus of rupture | 3 |
| 3. Shale, sandy, solid color; bricks show low toughness, low absorption, medium modulus of rupture..... | 10 |
| 2. Shale, sandy, clear definition, solid color, granulated texture, pulverizes in the hand..... | 5 |
| 1. Shale, gray, clear definition, easily fused; brick good toughness, high porosity, low modulus of rupture..... | 20 to 25 |

Each bed in the above section was analyzed by C. O. Bates, Chemist. The results are given below:

| | 8 | 7 | 6 | 5 | 4 | 3 | 2 | 1 |
|----------------------|--------|-------|--------|-------|-------|-------|-------|-------|
| Silica..... | 70.29 | 59.18 | 64.60 | 64.41 | 63.23 | 76.01 | 67.76 | 55.56 |
| Alumina..... | 15.18 | 21.63 | 19.20 | 20.43 | 24.52 | 11.94 | 14.46 | 21.33 |
| Combined water..... | 2.18 | 3.80 | 3.96 | 3.93 | 2.55 | 1.41 | 3.53 | 4.65 |
| Clay and sand..... | 87.65 | 84.61 | 87.75 | 88.77 | 90.30 | 89.36 | 85.75 | 81.54 |
| Oxide of iron..... | 7.32 | 9.00 | 7.68 | 5.88 | 5.28 | 5.40 | 8.52 | 10.56 |
| Lime..... | 0.80 | 1.06 | 1.02 | 0.34 | 0.32 | 1.57 | 1.16 | 1.59 |
| Magnesia..... | 1.72 | 1.85 | 1.37 | 1.71 | 0.99 | 1.04 | 2.36 | 2.94 |
| Soda and potash..... | 1.49 | 1.52 | 1.25 | 1.90 | 1.16 | 1.80 | 1.24 | 2.38 |
| Total..... | 11.33 | 13.43 | 11.32 | 7.83 | 7.75 | 9.81 | 13.28 | 17.47 |
| Moisture..... | 1.02 | 1.95 | 0.92 | 1.27 | 1.75 | 0.65 | 0.67 | 0.97 |
| Total..... | 100.00 | 99.99 | 100.01 | 98.77 | 99.80 | 99.82 | 99.70 | 99.98 |

For the entire assemblage the clay and sand aggregates 85.67 per cent and the fluxes 13.22 per cent, a blend which, when the mixing had been thoroughly done, yielded a good quality of pav-

ing brick. The bricks were thoroughly tested and gave excellent satisfaction. As they are no longer on the market, the results of the tests are omitted. The plant was equipped throughout with up to date machinery and was the only plant in the state to make use of the steam shovel in mining and loading the clay.

On the east side of the river, in Oak Park, the Flint Brick Company is operating an extensive plant which was established in 1893. The company mine their own coal from a nearby shaft. The product is shipped over the Flint Valley line of the street railway or hauled by team to the various parts of the city. The old pit section operated up to 1902 is as follows:

| | FEET. | INCHES. |
|---|-------|---------|
| 12. Boulder clay up to..... | 15 | |
| 11. Shale vari-colored, the lower portion is of the nature of a fire clay..... | 8 | |
| 10. Shale, buff to gray, gritty..... | 6 | |
| 9. Limestone, impure..... | 0 | 6 |
| 8. Shale, red and bluish-gray, laminated..... | 6 | |
| 7. Shale, brick red in color, clean, unctuous.. | 4 | |
| 6. Shale, light gray..... | 0 | 4 |
| 5. Shale, crumbly, gray..... | 1 | 6 |
| 4. Shale, blue..... | 28 | |
| 3. Shale, bituminous..... | 0 | 8 |
| 2. Coal, soft "pockety"..... | 1 | |
| 1. Fire clay..... | 1 | |

The section above number 4 is fully exposed in the pit. The lower numbers were encountered in sinking the shaft. In working the pit numbers 9 and 12 were wasted. The new pit opened just north of the wagon road which leads down to the plant, does not show the limestone ledge, as the beds dip slightly to the south and the drift is much thinner, ranging from zero up to three or four feet. The beds from 4 to 2, inclusive, are used without waste. Chemical analyses of the raw materials used give the following results:

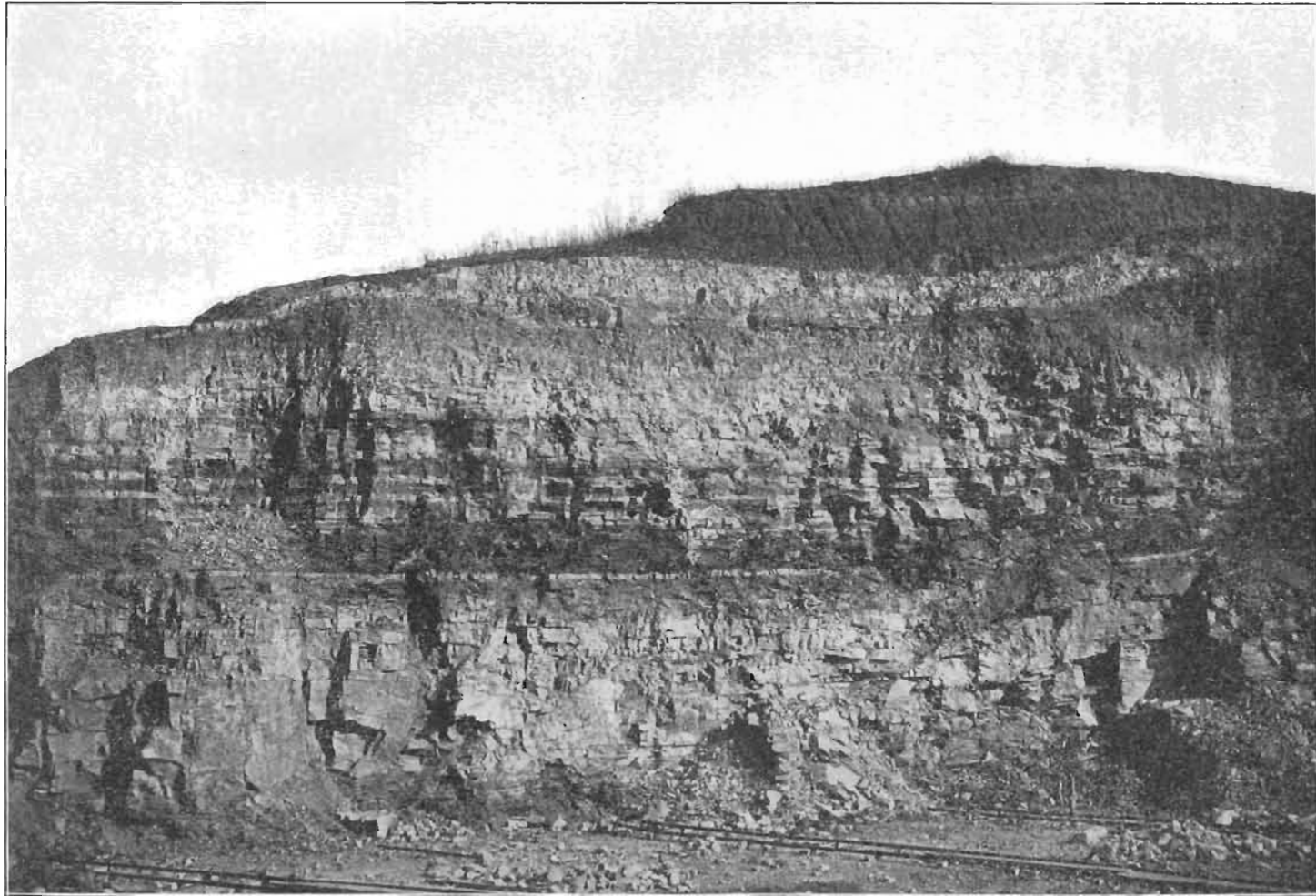

PLATE XXIII. Present pit of the Flint Brick Company, Des Moines, Iowa. About fifty feet of shales are exposed.

THE GEOLOGY OF CLAYS.

| | Bottom Clay. | Middle Clay. | Top Clay. | Green Brick. |
|--|--------------|--------------|-----------|--------------|
| Silica..... | 67.50 | 61.22 | 67.15 | 63.75 |
| Alumina..... | 15.75 | 21.12 | 15.47 | 19.78 |
| Combined water. | 3.22 | 33.75 | 4.37 | 2.92 |
| Clay and sand | 86.47 | 116.09 | 86.99 | 86.45 |
| Iron oxide..... | 4.80 | 5.28 | 2.88 | 5.75 |
| Lime..... | 2.57 | 1.80 | 3.17 | 1.55 |
| Magnesia..... | 1.57 | 1.44 | 2.72 | 1.22 |
| Potash..... | 0.95 | 0.63 | 0.24 | 0.54 |
| Soda..... | 1.56 | 0.89 | 0.58 | 1.20 |
| Total fluxes.. | 10.45 | 10.04 | 9.59 | 10.26 |
| Moisture, sulfur trioxide, carbon dioxide..... | 2.88 | 3.78 | 3.29 | 3.88 |

RATIONAL ANALYSES.

| | | | | |
|----------------------|--------|--------|--------|--------|
| Clay substance..... | 52.85 | 59.12 | 53.79 | 61.57 |
| Feldspar..... | 15.80 | 25.32 | 8.76 | 13.47 |
| Quartz..... | 25.99 | 9.59 | 33.31 | 20.53 |
| Calcium sulfate..... | 5.36 | 5.97 | 4.41 | 4.43 |
| Magnesium sulfate... | | | | |
| Calcium carbonate... | | | | |
| | 100.00 | 100.00 | 100.00 | 100.00 |

The green brick was taken as it came from the brick machine, and is supposed to represent the blend produced in actual practice from the various beds exposed in the pit. The mixture shrinks moderately in drying and burning and but small loss is sustained in either the drier or the kiln. The ware burns to a blue-black and produces a high grade paver. The finished product has been subjected to an elaborate series of tests, the results of which will be found in a later chapter. The plant is equipped with modern machinery throughout and is one of the largest producers of paving brick in the state. Building brick are also made to a limited extent.

Across the river from the Flint plant are the works of the Iowa Brick Company, which were installed about ten years ago. The pit worked until 1903 was as follows:



PLATE XXIV. Plant of the Flint Brick Company, Des Moines, Iowa.



FIG. 52. Pit of the Iowa Brick Company, Des Moines, Iowa.

| | FEET. |
|--|-------|
| 8. Shale, variegated, reddish-brown, mahogany reds, yellowish, bluish-drab, dark gray almost black, the colors mottled parallel to beds..... | 6 |
| 7. Shale, sandy, light yellowish-white, solid color.... | 6 |
| 6. Shale, slightly sandy at top, pale blue streaked with chocolate brown..... | 5 |
| 5. Shale, clear chocolate brown..... | 4 |
| 4. Shale, granular, dark solid drab with purple nodules..... | 3 |
| 3. Shale, bluish-drab..... | 6 |
| 2. Shale, streaks of brownish-drab and greenish to chocolate brown; stratification well defined.... | 6 |
| 1. Shale, clear dark drab, with olive green tinge..... | 2 |

The diversity of the shales is emphasized when the chemical analyses are inspected. As the pit was worked back into the bluff

the drift covering thickened greatly and stripping became so expensive that a new pit was opened west of the wagon road. The beds being developed at the present time are similar to those in the old pit and less expense is involved in wasting away the surface materials. The results of the analyses of beds 2 to 7, inclusive, are given below:

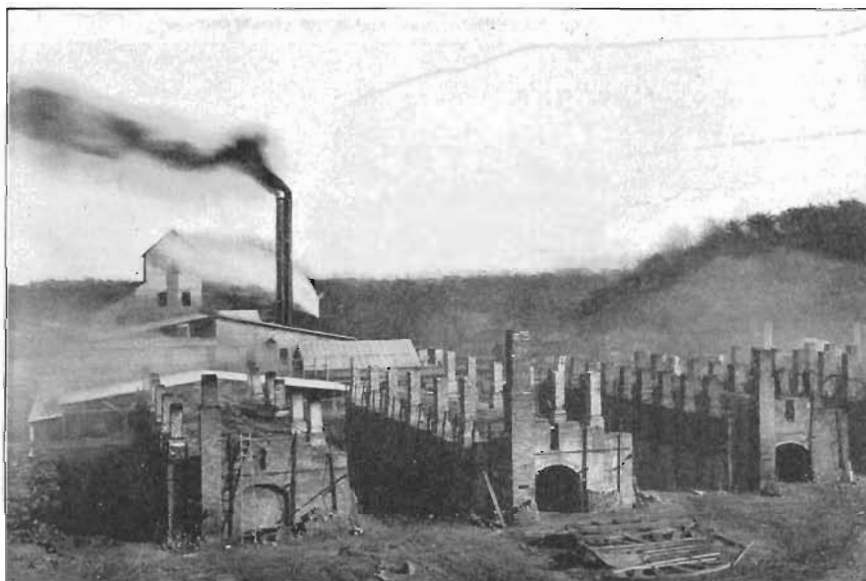

FIG. 53. A portion of the plant of the Iowa Brick Company showing multiple stack kilns in the foreground and the machinery buildings in the background.

| | 2 | 3 | 4 | 5 | 6 | 7 |
|----------------------|-------|-------|-------|-------|-------|-------|
| Silica | 61.59 | 67.40 | 60.43 | 56.29 | 65.22 | 73.43 |
| Alumina | 21.01 | 16.68 | 20.43 | 21.97 | 19.22 | 11.94 |
| Combined water | 4.51 | 1.44 | 6.82 | 3.59 | 2.66 | 4.33 |
| Clay and sand.. | 86.81 | 85.52 | 87.68 | 81.85 | 87.10 | 89.70 |
| Iron oxide | 4.79 | 4.31 | 1.91 | 8.63 | 3.35 | 3.83 |
| Lime | 3.58 | 3.17 | 6.59 | 3.17 | 2.99 | 1.00 |
| Magnesia | 2.16 | 1.42 | 1.87 | 1.34 | 1.44 | 0.86 |
| Potash | 0.52 | 0.35 | 0.21 | 0.60 | 0.59 | 0.05 |
| Soda | 1.13 | 1.38 | 0.90 | 1.48 | 1.59 | 0.95 |
| Total fluxes | 12.18 | 10.64 | 11.48 | 15.22 | 9.96 | 6.69 |
| Moisture | 0.42 | 0.25 | .89 | 0.83 | 0.39 | 0.63 |
| Sulfur trioxide | 0.95 | 1.00 | 0.45 | 1.15 | 1.80 | 1.65 |
| Carbon dioxide | | 2.99 | | 1.58 | 1.58 | 0.90 |

RATIONAL ANALYSES.

| | 2 | 3 | 4 | 5 | 6 | 7 |
|---------------------|--------|--------|-------|--------|--------|-------|
| Clay substance..... | 56.79 | 31.00 | 60.70 | 70.66 | 49.30 | 41.47 |
| Feldspar..... | 21.96 | 32.77 | 2.33 | 3.95 | 13.09 | 3.24 |
| Quartz..... | 19.63 | 30.56 | 36.97 | 21.79 | 34.01 | 55.29 |
| Calcium sulfate | } 1.62 | } 5.67 | | } 3.60 | } 3.60 | |
| Calcium carbonate | | | | | | |
| Magnesium carbonate | | | | | | |

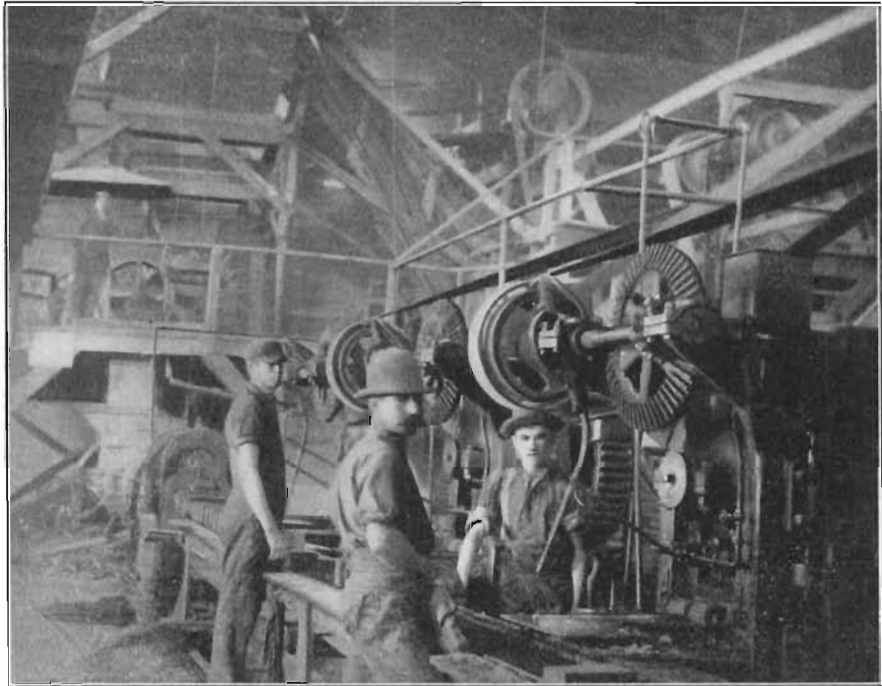

FIG. 54. Represses used by the old Iowa Brick plant, Des Moines, Iowa.

In the analyses where no carbon dioxide is given a separate determination was not made and the carbon dioxide is included in the loss on ignition. In the rational analyses where the sulfates and carbonates are not given separately, they are included in clay substance. Paving brick, common builders and hollow ware are the chief products. The company formerly turned out a small amount of terra cotta, which is of interest now as a deu-

onstration that certain of the clay seams could be used successfully in that line of work.

Southwest of the city, south of the Raccoon river, the shales are being developed extensively by the Barber Asphalt Company, successors to the Capitol City Brick and Pipe Company, and the Merrill Brick Company. The Barber plant is located on the Chicago and Great Western and the Keokuk and Western railways. The pit, below the glacial debris, shows the following shale series.

| | FEET. |
|---|-------|
| 7. Shale, medium light drab with slight seams of rust, plastic, very slightly gritty..... | 7 |
| 6. Shale, mottled and streaked, maroon to sea green, greenish and purplish-brown rust in seams. ... | 4½ |
| 5. Shale, medium dark bluish-drab, clean..... | 7 |
| 4. Fire clay, impure, mottled purplish-blue, dark gray, slight rust in seams..... | 4 |
| 3. Shale, soapy, but containing some grit, clear greenish-drab..... | 15 |
| 2. Shale, very dark, greenish-gray with slight seams of rust..... | 1½ |
| 1. Shale, clear blue, sandy..... | 10 |

It is evident, on a casual inspection of the above section, that the clays south of the city show an even greater diversity than those to the north. The analyses of the leading types of clays in the pit gave the following results:

| | 1 | 3 | 4 | 5 | 6&7 | IX |
|-------------------------|-------|-------|-------|-------|-------|-------|
| Silica..... | 51.16 | 57.64 | 69.40 | 62.22 | 67.46 | 58.56 |
| Alumina..... | 22.26 | 16.22 | 16.39 | 17.90 | 17.89 | 22.33 |
| Combined water | 7.15 | 7.43 | 5.75 | 5.02 | 4.04 | 7.11 |
| Clay and sand.. | 80.57 | 81.29 | 91.54 | 85.14 | 89.39 | 88.00 |
| Iron oxide | 11.20 | 10.32 | 3.36 | 5.52 | 5.12 | 2.87 |
| Lime..... | 1.29 | 1.78 | 0.81 | 1.58 | 0.75 | 3.60 |
| Magnesia | 1.94 | 1.58 | 0.42 | 1.55 | 1.72 | 1.44 |
| Potash..... | 2.92 | 2.17 | 1.04 | 2.81 | 1.09 | 0.29 |
| Soda..... | 0.87 | 12.41 | 0.54 | 2.76 | 1.87 | 1.08 |
| Total fluxes.... | 18.22 | 18.26 | 6.17 | 14.22 | 10.55 | 9.28 |
| Moisture..... | | | | | | |
| Sulfur trioxide. } 1.51 | 0.49 | 2.37 | .64 | 0.40 | 2.98 | |
| Carbon dioxide } | | | | | | |

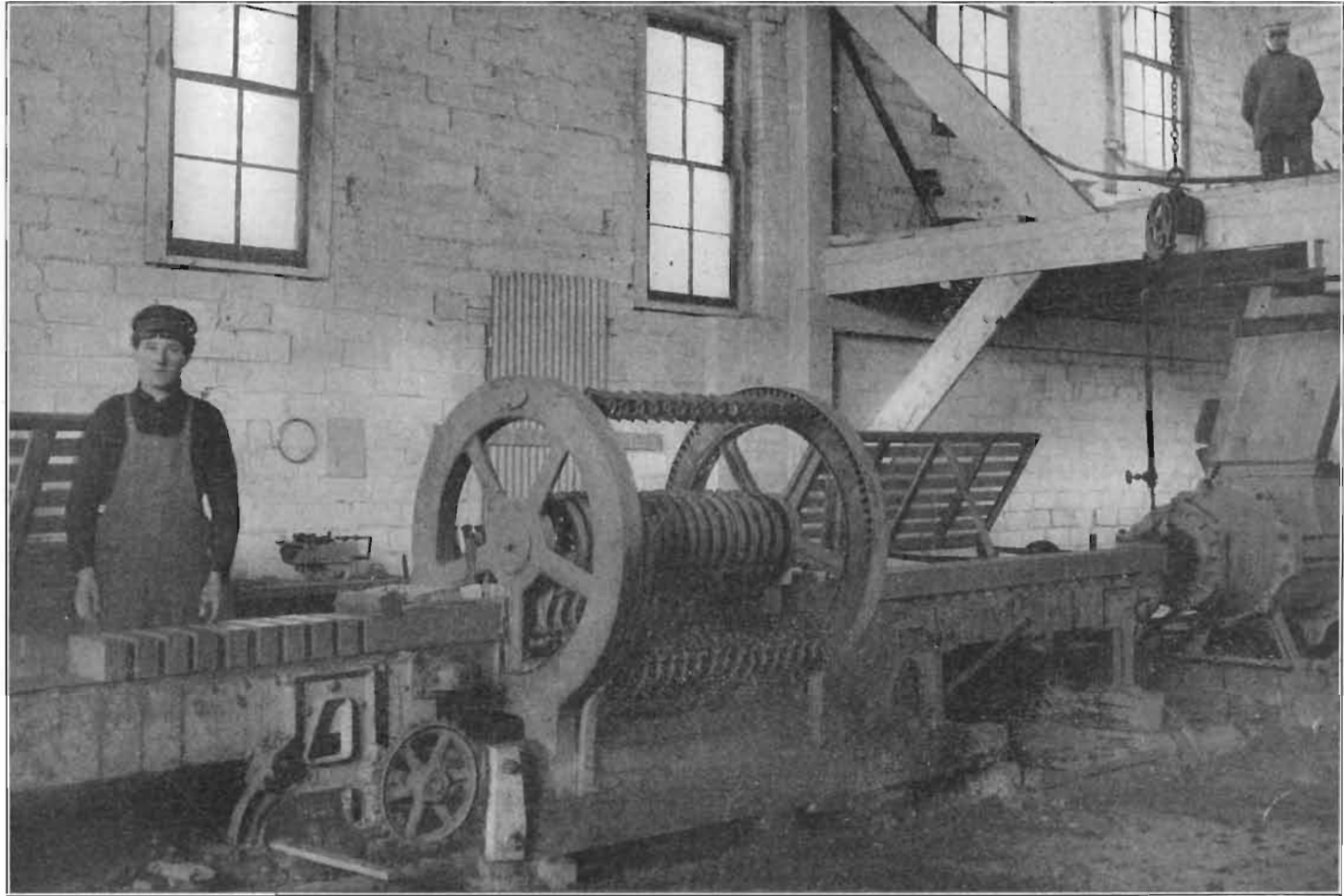

PLATE XXV. A modern rotary cutting table used by the Iowa Brick Company, Des Moines, Iowa.

RATIONAL ANALYSES.

| | | | | | | |
|----------------|---------------|---------------|---------------|---------------|---------------|---------------|
| Clay substance | 51.53 | 44.49 | 44.12 | 39.79 | 38.00 | 64.45 |
| Feldspar..... | 4.42 | 9.54 | 8.57 | 9.72 | 11.19 | 4.38 |
| Quartz..... | 44.05 | 45.97 | 47.31 | 50.49 | 50.81 | 31.17 |
| | <u>100.00</u> | <u>100.00</u> | <u>100.00</u> | <u>100.00</u> | <u>100.00</u> | <u>100.00</u> |

In the analyses the carbon dioxide is included in the loss on ignition and the calcium and magnesium sulfates and carbonates are included under clay substance in the rational analyses. Paving brick, common builders and drain tile are the chief manufactured products.



FIG. 55. Pit of the Merrill Brick Company, Des Moines, Iowa.

The shales become less constant to the southwest, and a thin section of coal and a band of bituminous shale appear. The pit of the Merrill brick plant, located about one-half mile to the southwest of the Barber, shows the following section:

| | FEET. |
|---|----------------|
| 7. Soil and loess | 3 |
| 6. Shale, bituminous | $\frac{5}{8}$ |
| 5. Shale, blue to gray and buff | 4 |
| 4. Shale, red-brown, more or less variegated, containing iron stone concretions..... | 20 |
| 3. Shale, blue to gray | 6 |
| 2. Coal | $1\frac{1}{2}$ |
| 1. Shale, light gray | 7 |

All of the material in the pit, except the coal and bituminous shale, is used in the manufacture of common builders and paving brick.



FIG. 56. A portion of the plant of the Merrill Brick Company, Des Moines, Iowa.

The Coal Measure outcrops around the base of Capitol Hill present a decidedly arenaceous facies which renders them undesirable for clay working. At the south end of the hill some twenty-five feet of irregularly bedded sandstone appear above the railway tracks. Northward along the river, the beds rise slowly and an excellent section may be viewed in the pit of the Iowa Pipe and Tile Company, which is given herewith:

| | FEET. |
|---|-------|
| 9. Shale, argillaceous, yellow..... | 20 |
| 8. Shale, clayey, gray, yellow and red..... | 8 |
| 7. Sandstone, gray, soft..... | 4 |
| 6. Shale, black, in part clayey..... | 1½ |
| 5. Sandstone, gray..... | 4 |
| 4. Coal, impure, shaly..... | 1½ |
| 3. Shale, light gray..... | 5 |
| 2. Shale, light gray to dark..... | 6 |
| 1. Shale, white, siliceous..... | 10 |

Sewer pipe and drain tile only are produced. Some difficulty is experienced in securing a good salt glaze, owing to the gypseous character of the clays.

The Iowa Pipe and Tile Company has opened a second plant about a quarter of a mile below the Flint plant. The shales used are closely similar to those developed in the pit of the Flint Brick Company. Drain tile, hollow block and common brick constitute the manufactured products.

Several other plants in and about Des Moines are using the shale clays in part or wholly, the most important being the Shackelford yard in North Des Moines, the Dale Brick Company in southeast Des Moines and the Newman Brick Company just outside the corporate limits, near Hastie.

The beds developed show no new phases of especial importance. The Pixley Conduit Company is operating a plant in South Des Moines.

Outside of the city the Coal Measure shales have been little used, although they are available at a number of points. At Altoona, the waste from a local coal mine was used formerly by mixing with surface material, which has later been abandoned. The Polk City Tile Works, at Polk City, uses shales which are hauled from a pit near the Des Moines river.

Poweshiek County.—Owing to the great thickness of drift and the fact that the streams have done little work in cutting, exposures of indurated rocks are rare. The Coal Measure shales show

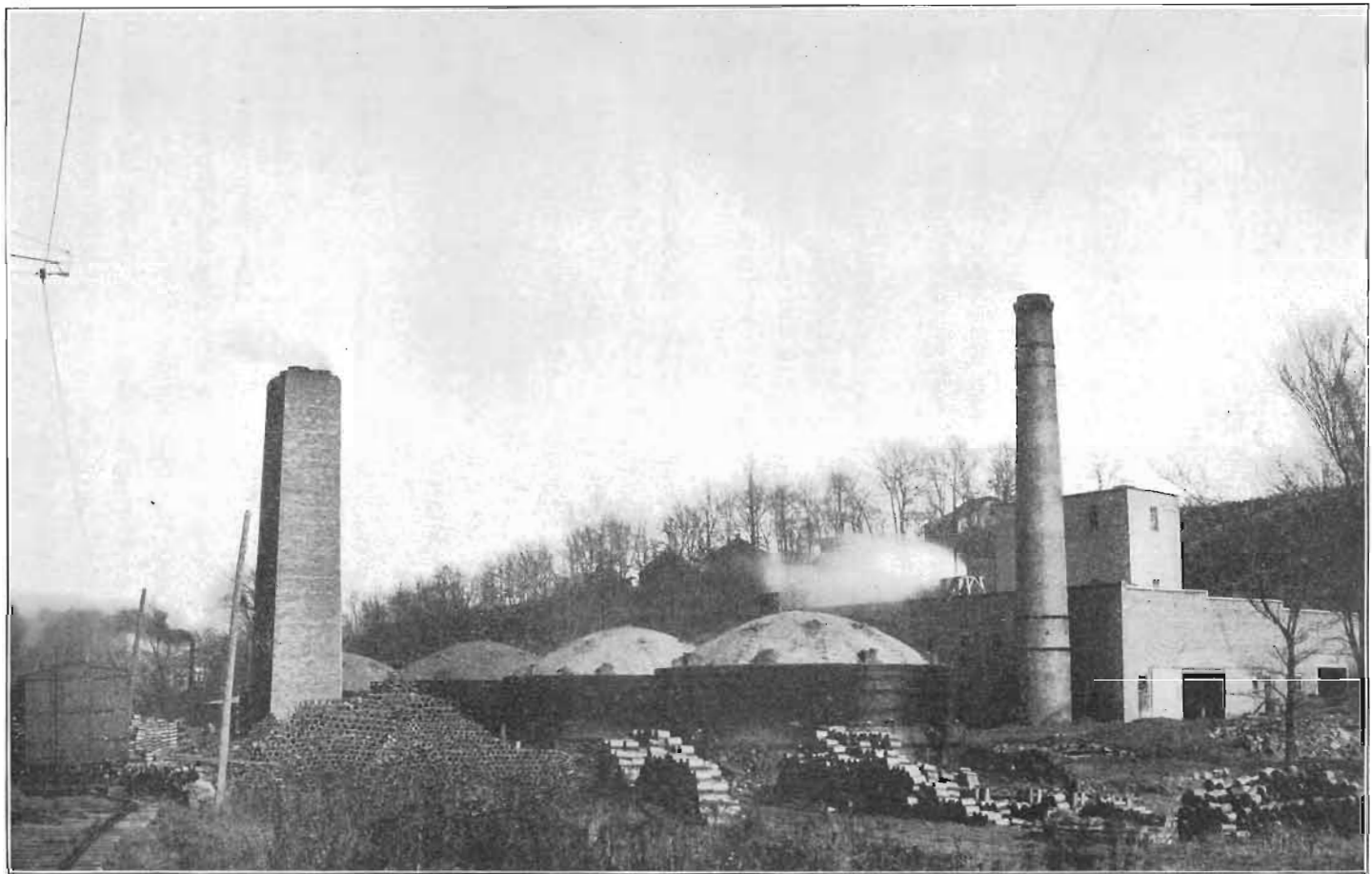

PLATE XXVI. Plant of the Des Moines Brick and Tile Company, Des Moines, Iowa.

somewhat obscure sections in Union and Sugar Creek townships. Even here beds which are accessible are not common. Near the old Petit mine workable shales are exposed. Some twenty-five feet of clay shales somewhat variable in character could be used in the manufacture of clay wares. No attempts have been made toward their utilization.

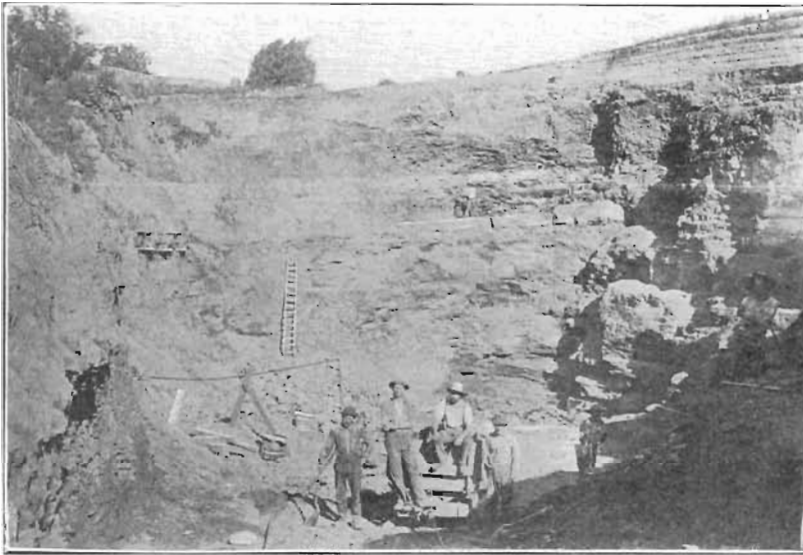

FIG. 57. Clay pit of the Davenport Brick and Paving Company, Buffalo, Iowa.

Scott County.—A number of Coal Measure outliers occur here which appear to belong to the Illinois coal field, but have been separated but recently by the narrow valley of the Mississippi river. The most extensive tract covers most of Buffalo township, in the southwestern part of the county, and sometimes about an equal distance into Muscatine county. The Davenport Brick and Paving Company are developing the shales at Buffalo. The pit shows the following beds:

| | FEET. |
|---|-------|
| 8. Loess | 7 |
| 7. Bowlder clay, red, brownish-red | 5 |
| 6. Shale, weathered gray and ochreous yellow readily disintegrating, joints and seams and spaces between laminae filled with ochreous accumulations.. | 5 |
| 5. Shale, black, finely laminated | 12 |
| 4. Shale, gray | 3 |
| 3. Shale, dark drab and black, brittle, fine-grained, containing ferruginous nodules and nodular layers | 42 |
| 2. Shale, gray, disclosed in shaft below bottom of pit..... | 26 |
| 1. Rock, hard ledge | |

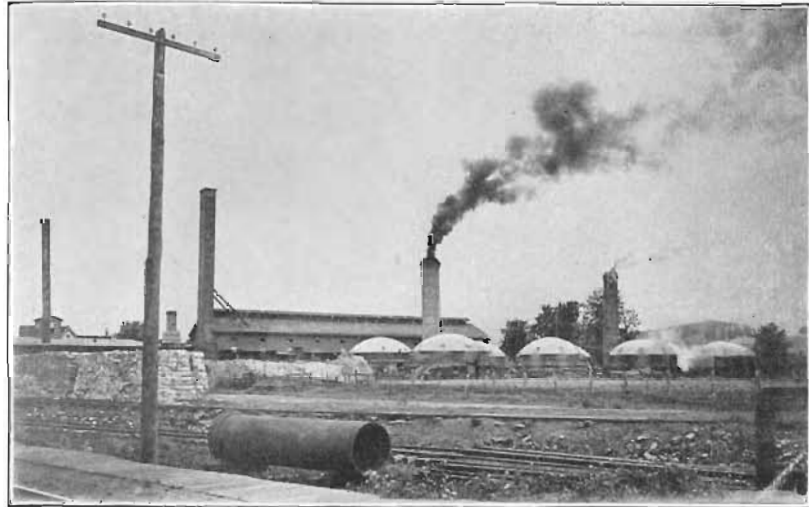

FIG. 53. Plant of the Davenport Brick and Paving Company, Buffalo, Iowa.

Common builders, paving brick, sidewalk and yellow ware constitute the manufactured products.

The next largest area in the county is situated about two miles southwest of LeClaire, directly on the river. At Island City the LeClaire Brick and Tile Company are using the shales in the manufacture of common brick and drain tile. The pit section is as follows:

| | FEET. |
|--|-------|
| 7. Loess and drift, variable in thickness..... | |
| 6. Cannel coal..... | 2 |
| 5. Potter's clay..... | 4 |
| 4. Coal..... | 1 |
| 3. Fire clay..... | 4 |
| 2. Shale, gray..... | 2 |
| 1. Shale, blue-black, to bottom of pit..... | 20 |



FIG. 59. Plant of the Le Claire Brick and Tile Company, Island City, Iowa.

Well borings in the immediate vicinity demonstrate that the shales continue down more than one hundred feet below the bottom of the pit, but no attempt has been made to utilize them.

Story County.—The county lies within the recognized limits of the Coal Measures, but owing to the great thickness of the glacial debris and the slight cutting of streams, shale exposures are comparatively rare. Pits have been opened and are being developed near Maxwell, Nevada and Roland. Shale outcrops along the Skunk river, near Story City, were formerly utilized to a limited extent. The pit at Maxwell is located about one mile east of town and shows the following beds:

| | FEET. |
|--|---------|
| 4. Drift, weathered above, but calcareous below..... | 6 |
| 3. Shale, gray, slightly arenaceous | 8 |
| 2. Shale, variegated, much iron-stained along the joint and bedding planes; a limonitic, concretionary layer occurs about two feet from the base; iron concretions are common throughout..... | 7 |
| 1. Sandstone..... | Exposed |

Common building brick and hollow ware are the chief manufactured products. Along the west branch of Indian creek the Coal Measure shales come near the surface in the vicinity of Nevada. About one mile west of town they are being developed by Mr. S. M. McHose. The pit shows the following section:

| | FEET. |
|---|---------------|
| 7. Drift, bowldery, calcareous | 5 |
| 6. Shale, blue, variegated; containing much ferruginous staining along the joint planes and known as "calico clay"..... | 12 |
| 5. Sandstone, gray..... | $\frac{1}{2}$ |
| 4. Shale, gray-blue, jointed; containing some concretion- ary matter..... | 3 |
| 3. Shale, carbonaceous | $\frac{1}{2}$ |
| 2. Fire clay..... | 2 |
| 1. Shale, jointed, highly ferruginous; exposed | 2 |

Common structural brick and drain tile are the chief products, although satisfactory paving brick and sidewalk block are made in varying quantities. With the exception of numbers 5 and 7, the entire section can be utilized. Sufficient iron is present to give a good color.

At Reland about eight feet of shales, light gray above and dark below, are available and are usually mixed with surface wash. Only the common wares are manufactured.

Taylor County.—The upper Coal Measures are supposed to form the superficial indurated rocks over the entire county. They comprise beds of hard limestone, bituminous and clay shales. Exposures of any note are practically limited to the western tier of townships, along the East Nodaway and West Fork rivers and their immediate tributaries. Coal has been

mined for some years along the East Nodaway, first by drifts and later by shafts. The shales and clays accompanying the coal seams are suitable for the manufacture of the common clay wares. They could not be worked extensively save by mining. None have been used up to this time.

Union County.—The upper Coal Measures extend over the entire county. Outcrops are rare save in the southeast quarter of the county. Along Grand river, below Afton Junction, sections showing shales and limestones are not uncommon, the former beds predominating. Some of the clay shales carry considerable calcareous matter, but many of the beds are pure enough, doubtless, for the common clay wares. No attempts have been made to develop them.

Van Buren County.—The Coal Measures present numerous outcrops along the Des Moines river and its tributaries, but have been but little developed. They consist essentially of various colored shales, with occasional thin seams of coal and friable sandstone. About one mile northeast of Douds Station, in Village township, the Findlay mine section is as follows:

| | FEET. |
|---|--------|
| 12. Concealed..... | 20 |
| 11. Shale, blue, argillaceous | 10 |
| 10. Coal | ½ |
| 9. Shale, arenaceous, filled with plant remains | 1 |
| 8. Coal | ½ |
| 7. Shale, becoming more argillaceous below | 3 |
| 6. Coal..... | ½ |
| 5. Sandstone, filled with plant remains | 1 |
| 4. Fire clay..... | 1 to 2 |
| 3. Shale, black, fissile above, more compact below and filled with clay-ironstone concretions..... | 4 to 5 |
| 2. Coal, sometimes partially cut out by the nodular masses above | 3 to 4 |
| 1. Fire clay..... | 2 |

The beds are quite variable, the coal seams often not appearing. The coal horizons are usually accompanied by beds of fire clay, some of which are suitable for the manufacture of pottery and

have been used to a limited extent for that purpose, as at Vernon and Farmington.

Wapello County.—The Coal Measures cover practically the entire county. The Saint Louis limestone appears along the Des Moines river and its immediate tributaries from Ottumwa to the northwest corner of the county, and the river has uncovered a small tract in the southeast corner. Representative shale sections may be viewed at numerous points, but have been developed only at Ottumwa. Along Bear creek, about two miles west of the city, near the Kansas City division of the Chicago, Milwaukee & Saint Paul railway, the following beds may be observed:

| | FEET. |
|---|-------|
| 15. Drift..... | 20 |
| 14. Shale, argillaceous, gray, sandy in upper part | 20 |
| 13. Shale, black carbonaceous, fissile | 3 |
| 12. Sandstone | 3 |
| 11. Shale, gray, argillaceous | 2 |
| 10. Shale, black, fissile, carbonaceous | 5 |
| 9. Coal, impure and bony, pyritic | 1½ |
| 8. Fire clay, filled with plant remains | 1 |
| 7. Shale, gray, argillaceous..... | 5 |
| 6. Shale, black | 6 |
| 5. Sandstone | ½ |
| 4. Shale, black | 4 |
| 3. Coal, bony, impure..... | 1½ |
| 2. Shale, black, carbonaceous, fissile, rich in plant remains | ½ |
| 1. Shale, gray, argillaceous, exposed to creek | 20 |

In the above section the coal seams, sandstone layers and drift could not be used, and perhaps some of the bituminous shales would need to be rejected. The gray shales would undoubtedly yield a good grade of clay ware and are present in sufficient quantities to permit the safe use of much of the bituminous material which could not be used alone.

Near the limits of the city, to the northwest, the Ottumwa Brick and Construction Company have been in successful operation for a number of years. Their pit section is as follows:

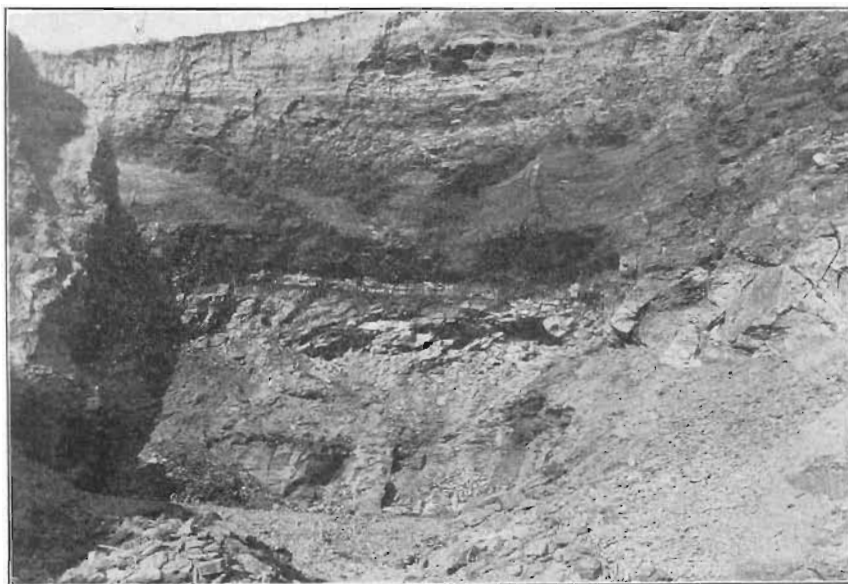

FIG. 60. Pit of the Ottumwa Brick and Construction Company, Ottumwa, Iowa.

| | FEET. |
|--|---------|
| 12. Drift | 3 |
| 11. Shale, argillaceous, gray..... | 20 |
| 10. Shale, black | 4 to 10 |
| 9. Coal | 1 |
| 8. Fire clay..... | 1 |
| 7. Sandstone, argillaceous..... | 5 to 7 |
| 6. Shale, black, fissile..... | 2 |
| 5. Sandstone, argillaceous, gray, in single ledge..... | 4 |
| 4. Shale, gray argillaceous..... | 4 |
| 3. Shale, black..... | 1 |
| 2. Coal..... | 3 to 4 |
| 1. Fire clay..... | 6 to 8 |

The beds are exceedingly variable when traced laterally. All are used in the manufacture of clay wares save the coal seam, number 2, which has been used for fuel. The green brick hold their shape well in the drier and in the kiln, and vitrify with difficulty when numbers 5 and 7 are used. A good grade of vitrified products can be made from the gray, argillaceous shales. Common brick and hollow ware are successfully burned in a Dunn compartment continuous kiln.

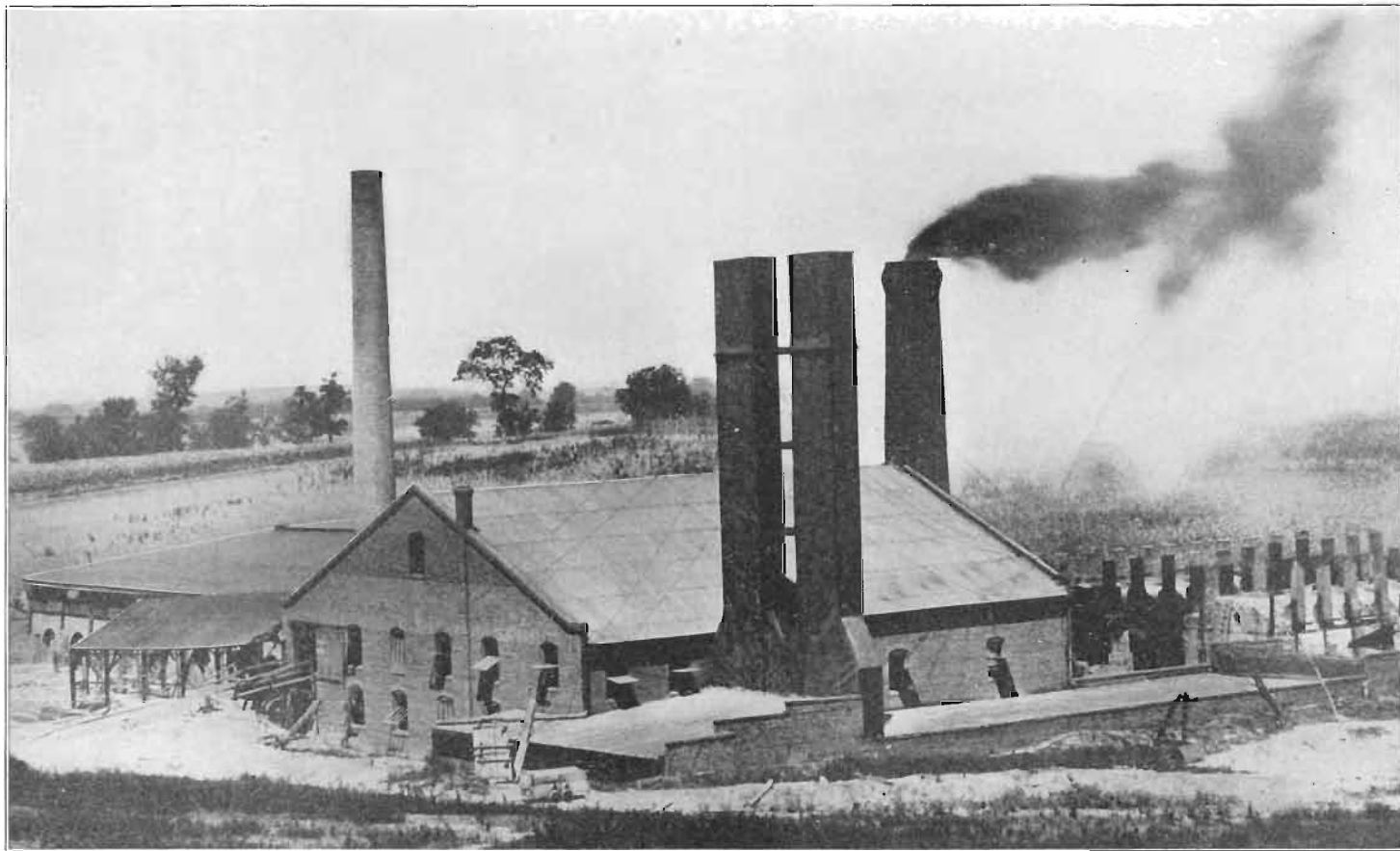

PLATE XXVII. A portion of the plant of the Ottumwa Brick and Construction Company, Ottumwa, Iowa.

About two miles southeast of Ottumwa on Sugar creek, near the bridge of the Chicago, Burlington and Quincy railway, the following section may be viewed:

| | FEET. |
|--|----------|
| 9. Sandstone..... | 10 |
| 8. Shale, black fissile..... | 12 |
| 7. Coal..... | 2 |
| 6. Fire clay..... | 3 |
| 5. Coal..... | 2 to 4 |
| 4. Fire clay and argillaceous shale..... | 10 to 12 |
| 3. Shale, black..... | 15 to 20 |
| 2. Obscured, probably shale..... | 8 to 10 |
| 1. Saint Louis limestone exposed in creek bottom | 4 |

All of the beds above number 1 with the exception of the coal seams and a portion of number 9 could be used doubtless in the manufacture of clay goods. The coal seams afford an abundance of fuel.

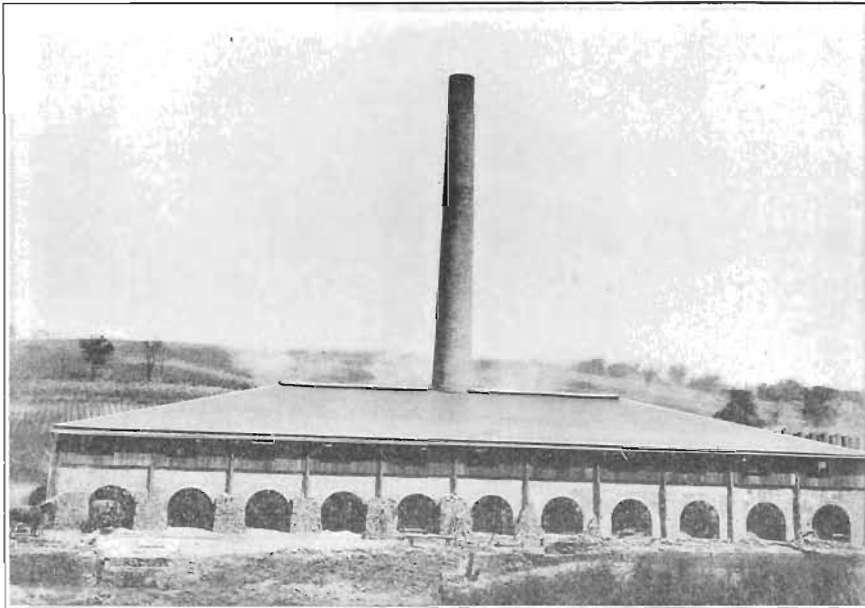

FIG. 61. Compartment continuous kiln, modified "Dunn" pattern; Ottumwa Brick and Construction Company, Ottumwa, Iowa.

Recently considerable exploratory work has been done about one and one-half miles northeast of the city along the head waters of Sugar creek. One of the most important test pits reveals the following section:

| | FEET. |
|---|----------------|
| 7. Drift and surface wash; the lower portion charged with pebbles and boulders..... | 0 to 10 |
| 6. Shale clay, yellow and clayey where weathered, gray where protected | 6 |
| 5. Coal, soft, impure..... | $\frac{3}{4}$ |
| 4. Shale, dark, bluish-black, argillaceous..... | $6\frac{1}{2}$ |
| 3. Shale clay, light colored, a putty clay when weathered | 5 |
| 2. Coal, bony..... | $\frac{1}{6}$ |
| 1. Shale, compact, light gray, exposed..... | 3 |

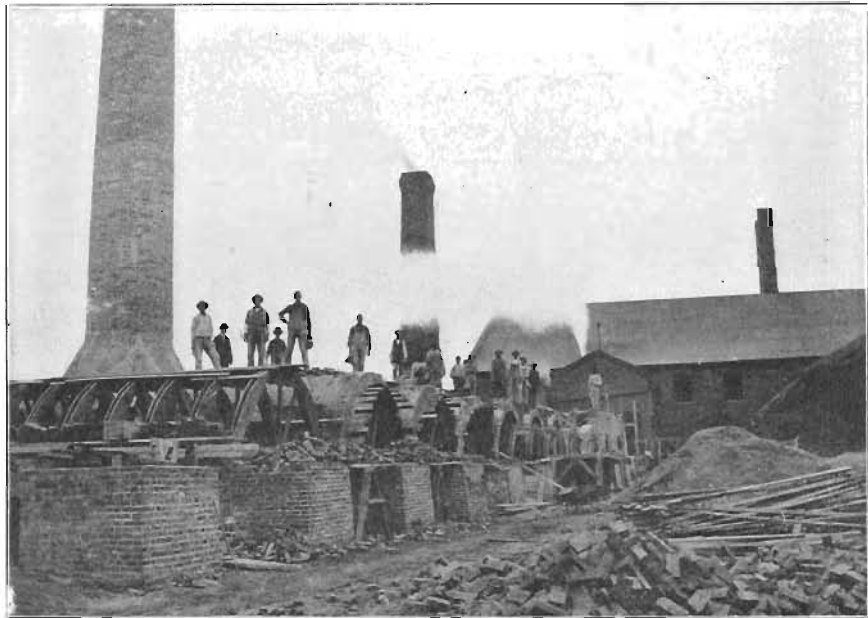

FIG. 62. Modified Dunn continuous kiln in process of construction; Ottumwa Brick and Construction Company, Ottumwa, Iowa.

With the exception of the thin coal seams and the drift the entire section could be utilized and a large variety of wares could be produced. The shales show considerable variations in the numerous outcrops exposed within a radius of a few hundred

yards. Two hundred yards east of the pit described, fifteen feet of gray shale are visible along a sharp gully. This shale quite closely resembles number 1 in the section but is more siliceous. Below are appended the analyses of numbers 1, 3, 4 and 6 in the section and a sample from the gully mentioned which is given as sample x.

| | 1 | 3 | 4 | 6 | X |
|-----------------------|-------|-------|-------|-------|-------|
| Silica | 58.84 | 53.86 | 49.00 | 55.00 | 55.87 |
| Alumina | 21.70 | 26.28 | 29.31 | 24.63 | 23.79 |
| Combined water | 6.95 | 8.06 | 10.38 | 5.36 | 4.87 |
| Clay and sand | 87.49 | 88.20 | 88.69 | 84.99 | 84.53 |
| Iron oxide | 5.16 | 4.32 | 4.56 | 7.92 | 9.36 |
| Lime | .91 | .12 | .57 | .82 | .46 |
| Magnesia | .67 | .43 | .24 | .71 | .86 |
| Potash | 1.90 | 2.52 | 1.22 | 1.82 | 1.52 |
| Soda | 2.45 | .43 | .67 | .98 | 1.06 |
| Total fluxes | 11.09 | 7.82 | 7.26 | 12.25 | 13.26 |
| Moisture | .84 | 3.02 | 3.25 | 2.49 | 1.85 |
| Sulfur trioxide | .45 | 1.22 | .94 | .16 | .35 |

RATIONAL ANALYSES.

| | | | | | |
|----------------------|--------|--------|--------|--------|--------|
| Clay substance | 50.20 | 58.64 | 51.46 | 41.20 | 45.36 |
| Feldspar | 23.53 | 6.27 | 6.32 | 14.19 | 12.73 |
| Quartz | 26.22 | 35.09 | 42.22 | 44.61 | 41.91 |
| Total | 100.00 | 100.00 | 100.00 | 100.00 | 100.00 |

Sample number 1 is highly plastic, burns a light buff color and is comparatively free from impurities and would undoubtedly give excellent service as a potter's clay. It shows moderate shrinkage and could be used to advantage in the manufacture of face brick and fancy shapes. Number 3 burns a gray buff, while numbers 6 and x burn a deep red and vitrify easily. A mixture of all burns a deep red at a moderate temperature and readily takes on the blue-black hue at the point of vitrification, the color so much prized by manufacturers of paving brick. Actual kiln tests were made by the Barber Asphalt Company of Des Moines and gave excellent results.

Shales are exposed at numerous points in other portions of the county, but no attempt has been made to exploit them with the exception of small quantities of fire clay mined at some of the coal mines.

Warren County.—Warren county lies wholly within the Coal Measures and is deeply trenched by numerous streamways, thus exposing many sections. Shales, argillaceous to arenaceous, constitute the predominant type of rocks. Occasional thin bands of limestone and thicker beds of friable sandstone appear. Many of the outcrops are too far away from established lines of railway to be available at present for the shipping trade. The sections given below may be considered representative and do not in any way exhaust the possibilities.

RICHMOND TOWNSHIP, SEC. 24, S. W. QR. NE. 1.

| | FEET. |
|--|-------|
| 3. Drift | 12 |
| 2. Shale, clayey to sandy, thinner banded above, heavier below..... | 32 |
| 1. Sandstone, red, heavy, cross-bedded, with pyritic concretions exposed..... | 14 |

On the same side of the river, about one mile south of the above exposure, on section 25, the beds are as follows:

| | FEET. |
|---|-------|
| 5. Drift, variable in thickness. | |
| 2. Shale, bluish-gray, thinly laminated with sandstone below | 40 |
| 1. Talus to river | 9 |

The shales in both sections would undoubtedly yield a fair grade of the common clay wares. Good sections continue to the southwest along South river, one of the best appearing on the southeast quarter of northeast quarter of section 3, in Union township, which is as follows:

| | FEET. |
|---|-------|
| 10. Drift | 15 |
| 9. Shale, black | 2 |
| 8. Coal | 1 |
| 7. Shale, argillaceous, gray..... | 4 |
| 6. Limestone, gray, fossiliferous..... | 2 |
| 5. Shales, argillaceous, gray..... | 8 |
| 4. Coal..... | 3½ |
| 3. Shale, bluish-gray, sandy below..... | 34 |
| 2. Coal | 1 |
| 1. Shale, exposed to river..... | 2½ |

All of the members developed here could be used in clay manufactures, save the coal seams and numbers 6 and 10. The coal could be used to burn the wares and furnish heat and power for their manufacture. The beds dip gradually to the southwest. On section 9 a similar though less extensive section may be viewed. Good sections are also visible in sections 17 and 30.

South of Ackworth, near the Chicago, Burlington and Quincy railroad, a complicated series of beds are exposed. The section is given below:

| | FEET. |
|--|-------|
| 13. Loess, variable in thickness. | |
| 12. Limestone, compact, fossiliferous | 1 |
| 11. Shale, argillaceous, black..... | 4 |
| 10. Coal | ¾ |
| 9. Fire clay above, shale clay below | 8½ |
| 8. Sandstone, irregular, varying from shaly sandstone above, to true shale below..... | 1½ |
| 7. Sandstone, gray, friable | 1½ |
| 6. Shale, gray, thin irregular band, arenaceous | 6½ |
| 5. Sandstone, reddish-brown | ½ |
| 4. Shale, argillaceous, gray above and dark below.... | 6½ |
| 3. Coal | ½ |
| 2. Fire clay and shale | 1 |
| 1. Talus to river (probably shale)..... | 2 |

The above section could be used in its entirety, with the exception of number 12, and perhaps portions of 5, 7, 8, and 10 would need to be rejected. The beds assume a more arenaceous facies to the southwest, and while important seams of shale still persist, the outcrops are considerably obscured by the heavy sandstone talus and drift debris.

In the southeast corner of the county, along Whitebreast creek, a heavy sandstone appears near the top of the section and greatly obscures the beds below. Thick shale beds are known to be present but could only be developed by mining.

The Winterset branch of the Chicago, Rock Island and Pacific railway closely follows Middle river across the county and renders accessible commercially the numerous shale outcrops. South of Carlisle, above the wagon bridge in section 15, the following series of beds are exposed:

| | FEET. |
|--|----------------|
| 8. Shale, argillaceous | 1 |
| 7. Coal | $\frac{1}{2}$ |
| 6. Shale, clay | 5 |
| 5. Sandstone | $1\frac{1}{2}$ |
| 4. Shale, argillaceous, dark below | 3 |
| 3. Coal | $\frac{3}{4}$ |
| 2. Fire clay and shale, containing nodular bands and thin seams of sandstone | 14 |
| 1. Shale, argillaceous, dark above, exposed to river | 2 |

With the exception of numbers 3 and 5, the section in its entirety could be utilized. At Summerset the sandstone members come in more prominently near the base than in the preceding section. The sequence is as follows:

| | FEET. |
|------------------------------------|----------------|
| 9. Loess | 14 |
| 8. Sandstone, calcareous | $\frac{5}{8}$ |
| 7. Shale, argillaceous | $6\frac{1}{2}$ |
| 6. Coal | 1 |
| 5. Fire clay | $4\frac{1}{2}$ |
| 4. Shale, sandy, gray | $3\frac{1}{2}$ |
| 3. Sandstone, gray | 1 |
| 2. Shale, gray | 2 |
| 1. Sandstone, heavily bedded | 2 |

About a mile and one-half southwest of Spring Hill a fairly clean section is exposed and presents only a moderate amount of stripping. The following beds may be observed:

| | FEET. |
|---|-----------------|
| 10. Loess..... | 2 |
| 9. Coal, badly weathered..... | $\frac{1}{2}$ |
| 8. Coal, gray, with thick bands of sandstone..... | 10 |
| 7. Shale, blue above and black below..... | 4 |
| 6. Sandstone, concretionary, calcareous..... | $\frac{3}{4}$ |
| 5. Shale, gray to black..... | 2 |
| 4. Coal..... | 1 |
| 3. Fire clay..... | 4 $\frac{1}{2}$ |
| 2. Sandstone, gray, heavily bedded..... | 1 $\frac{3}{4}$ |
| 1. Shale exposed..... | 2 $\frac{1}{2}$ |

The Coal Measures continue prevailingly argillaceous to the southwest, but the sections become more obscured with talus. Near Bevington, in Madison county, an excellent shale section may be seen and is noted in the description of the Coal Measures for that county.

The Coal Measure beds exposed along North river are prevailingly shales, but are less accessible at the present time than those of the Middle river district because of lack of railway facilities. One of the outcrops which is most easily accessible appears north of Greenbush, in section 30 of Greenfield township. The beds exposed are as follows:

| | FEET. |
|---|---------------|
| 6. Loess and drift, variable in thickness. | |
| 5. Shale, argillaceous, light..... | $\frac{1}{2}$ |
| 4. Coal, impure and weathered..... | $\frac{1}{2}$ |
| 3. Shale, compact above and soft below..... | 30 |
| 2. Sandstone, gray..... | $\frac{1}{2}$ |
| 1. Shale, argillaceous, blue exposed..... | 20 |

A coal seam is said to lie just below the river bed. The entire section can be utilized save where the drift carries too many pebbles and boulders. Numerous sections, less extensive than those given above appear along the tributaries of the principal streams, or occur within easy working distance of the surface inland, but sufficient have been given to demonstrate the bountifulness of the supply of raw materials which have been but sparingly developed. Small potteries in the vicinity of Carlisle and Hartford

have used the fire clays of the neighborhood for a number of years, but in amount so small as to be scarcely worthy of mention.

Wayne County.—Notwithstanding the fact that the upper Coal Measures cover the entire county, exposures are rare owing to the great thickness of Pleistocene deposits and the absence of large streams. Occasional much obscured outcrops appear in the vicinity of Confidence, in the northeastern portion of the county. Shales predominate and are usually accompanied by a thin coal seam. Near Seymour, thick seams of clay shales of good quality are known to exist, through exploratory work for coal. They could not be developed extensively, however, save through great expense by stripping or the adoption of mining methods. The argillaceous deposits are but little known and no attempts have been made toward their utilization.

Webster County.—With the exception of small isolated patches of Saint Louis limestone uncovered by the Des Moines river in the northern part of the county, and two detached areas in the inland portions of the county, the Coal Measures are believed to cover the county. The Des Moines river has cut a deep trench across the county and good shale sections are confined to the immediate vicinity of the river and a few of its larger tributaries. The heavy mantle of drift and the prevalently steep slopes along the greater streamways have produced heavy deposits of talus which have obscured greatly the underlying Coal Measure series. Notwithstanding these drawbacks, the county possesses the compensating advantages of splendid location, thick shale beds of good quality and fuel close at hand. The shales have been developed at a number of points.

Webster county occupies a strategic position with reference to the great undrained area covered by the Wisconsin drift. The energies of all of the factories operating in the county are largely devoted to the manufacture of drain tile. Their closest competitors are the Mason City plants. In the vicinity of Fort Dodge the

pit at the Kime brickyard gives some idea of the extent and variability of the shales. The section is as follows:

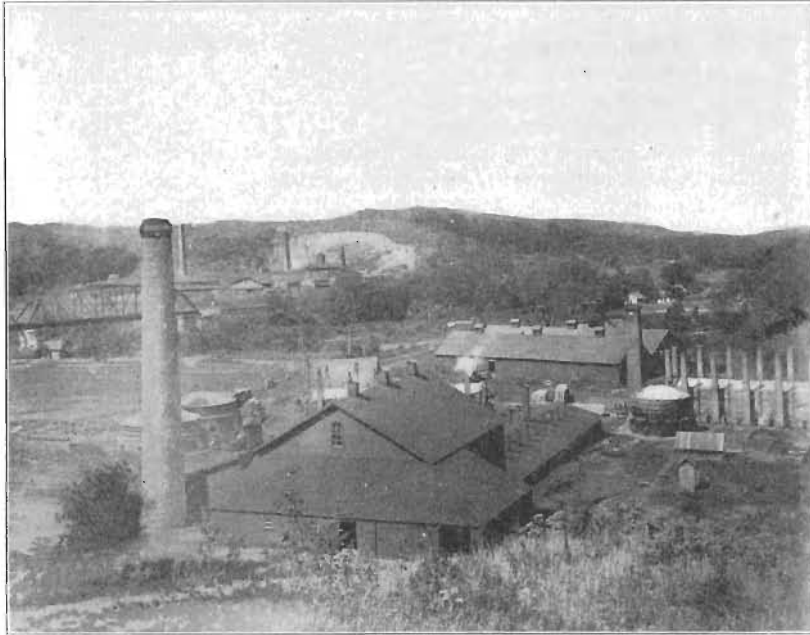

FIG. 83. Two of the Fort Dodge brick plants. In the foreground are the works of the Fort Dodge Brick and Tile Company; in the background the Fort Dodge Clay Works.

| | FEET. |
|---|-------|
| 11. Drift and soil..... | 3 |
| 10. Shale, black, bituminous | 4 |
| 9. Coal | 1½ |
| 8. Clay | 3½ |
| 7. Coal | 1½ |
| 6. Sandstone, soft | ½ |
| 5. Fire clay..... | 5 |
| 4. Shale, dark colored, bituminous, fissile below | 2½ |
| 3. Shale, dark colored | 2 |
| 2. Shale, light colored | 2½ |
| 1. Shale, dark colored, exposed | 10 |

Almost the entire section below the drift could be utilized in the manufacture of a wide range of clay wares.

The plant of the Fort Dodge Brick and Tile Company is located on the east bank of the river, north of the Illinois Central

railway bridge. The pit shows signs of slides and the various layers are somewhat irregular. The pit section is as follows:

| | FEET. |
|--|----------------|
| 7. Surface wash and drift | 4+ |
| 6. Shale, coaly..... | $\frac{3}{4}$ |
| 5. Shale, clayey, yellow to gray, pyritic | 8 |
| 4. Sandstone, impure | 1 |
| 3. Shale, argillaceous, gray | $2\frac{1}{2}$ |
| 2. Shale, dark gray to black, fissile in the upper part... | 7 |
| 1. Shale, argillaceous, light blue, exposed | 18 |

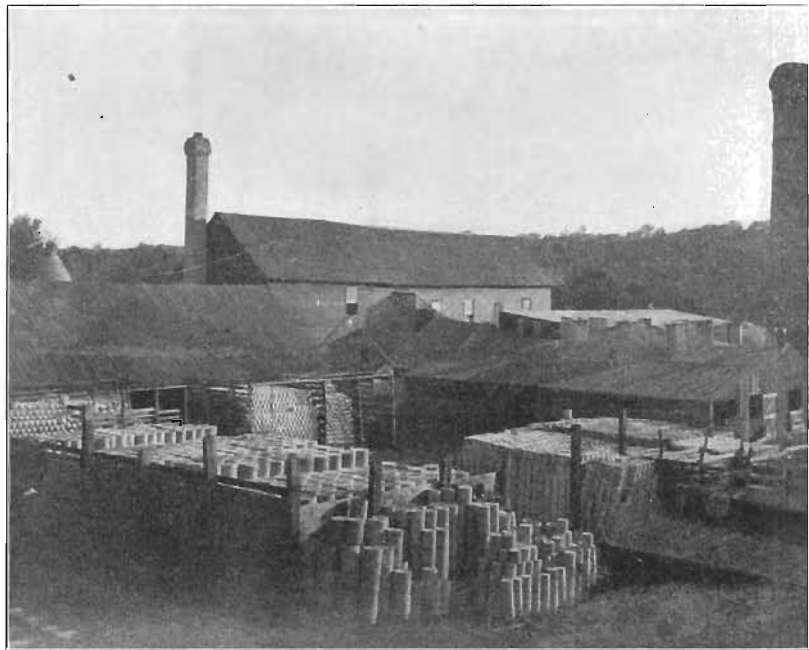

FIG. 64. A portion of the plant of the Fort Dodge Stoneware Company, Fort Dodge, Iowa.

Number 1 carries occasional calcareous concretions, pyrite and gypsum crystals. It is known locally as the potter clay and burns to a light gray or buff. The dark clay shales above the potter clay burn red. The entire section, with the exception of portions of the sandstone and drift, can be used. The various grades of brick, drain tile and sidewalk blocks are the principal manufactured products.

The shales are also being developed on the west side of the river. The plant of the Fort Dodge Clay Works is located south of the Illinois Central railway. The pit section shows the following beds:

| | FEET. |
|--|---------------|
| 5. Drift | 5 to 20 |
| 4. Shale, clayey, variegated, siliceous in lower part..... | 6 |
| 3. Shale, impure, coaly..... | $\frac{1}{2}$ |
| 2. Shale, argillaceous, light to dark gray | 25 |
| 1. Sandstone | 1 |

Numbers 2 and 4 are the principal members worked. A Radford "Monarch" continuous kiln is used for burning the structural brick. It contains sixteen chambers and one chamber is burnt per day. The products are about the same as in the preceding. The company has opened a new pit recently farther up the Lizard and have secured a better shale section with less striping.

Several other pits in and about Fort Dodge show sections of from thirty to fifty feet of shales suitable for the manufacture of the various grades of clay products, including paving brick. The overlying drift is of variable thickness and because of its large lime content must be carefully removed to insure high grade ware. The Bradshaw Brick Company has been in successful operation for a number of years. The product includes drain tile, building block, common builders, pavers and sidewalk block.

A potter's clay is obtained under one of the coal seams of the neighborhood from a small mine about one-half mile north of the city, on the west bank of the river. This clay has been used by the Fort Dodge Pottery Company and yields a good grade of stoneware. Analyses of the clay were made and are given below



PLATE XXVIII. Pit of the Lehigh Brick and Tile Company, Lehigh, Iowa.

| | FIRST QUALITY. | SECOND QUALITY. |
|---|-------------------|--------------------|
| Silica | 66.00 | 63.83 |
| Alumina | 19.32 | 17.55 |
| Combined water..... | | |
| Clay and sand | 85.32 | 81.38 |
| Iron oxide | 0.80 | 2.75 |
| Lime | 2.85 | 2.94 |
| Magnesia | 0.54 | 0.57 |
| Potash | 1.15 | 0.67 |
| Soda..... | 2.49 | 0.79 |
| Total fluxes | 6.83 | 7.72 |
| Moisture and undetermined | 6.84 | 8.54 |
| Carbon dioxide..... | | 2.36 |
| Insoluble in sulfuric acid and sodium carbonate..... | 58.55 | 68.69 |

The first quality clay compares favorably with the clay used at Zanesville, Ohio, and other clays equally well known.

South of Fort Dodge the Coal Measure shales outcrop at numerous points and have been quite extensively developed near Coalville and Leligh. Northwest of Coalville, west of the Des Moines, Johnson Brothers are operating a plant located on the Minneapolis and Saint Louis railway. Their pit shows the following section:

| | FEET. |
|--|-------|
| 6. Alluvium on the 70 ft. terrace. Mainly fine sand, silt and clay; few pebbles present. Imperfectly stratified; varies up to | 4 |
| 5. Drift, bowldery, blue-gray to yellowish along the seams, varies from..... 1 to | 2 |
| 4. Drift residuum, composed chiefly of limonite concretions, rotten granite bowlders, greenstone and limestone pebbles. The pebbles rarely exceed 3 inches for greatest diameter. The upper portion is a peaty brown of putty-like consistency. The layer bears evidence of age and varies from 1 to | 1½ |
| 3. Shale, variegated, sandy, "Calico rock", body color bluish-gray, cracks and seams stained red, often a bright red..... | 7 |
| 2. Sandstone, yellowish-gray, forms an indurated ledge up to..... | 1½ |
| 1. Shale, bluish-gray, the principal bed in the pit, light bands appear occasionally; exposed..... | 12 |

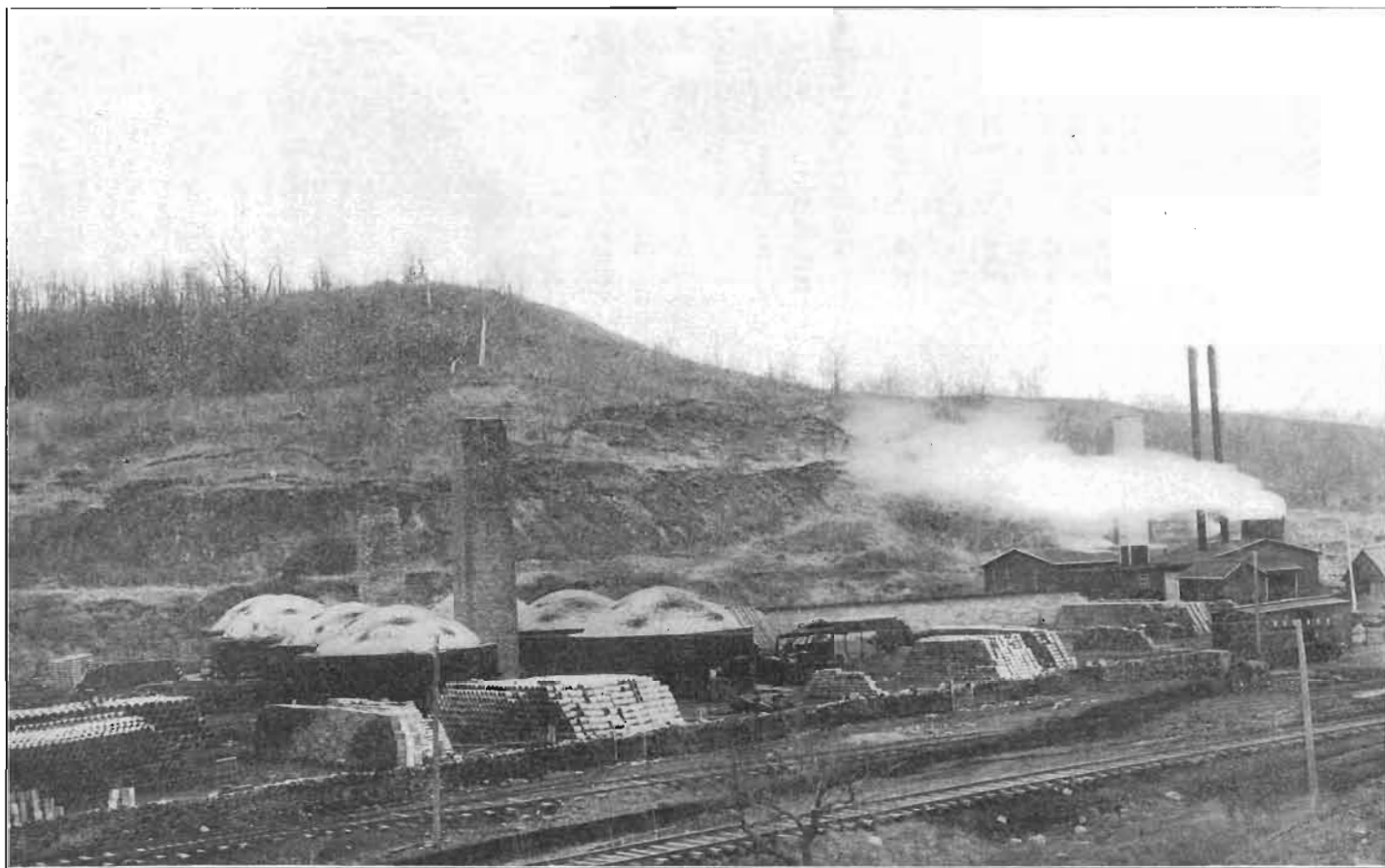

PLATE XXIX. Plant of the Lehigh Brick and Tile Company, Lehigh, Iowa.

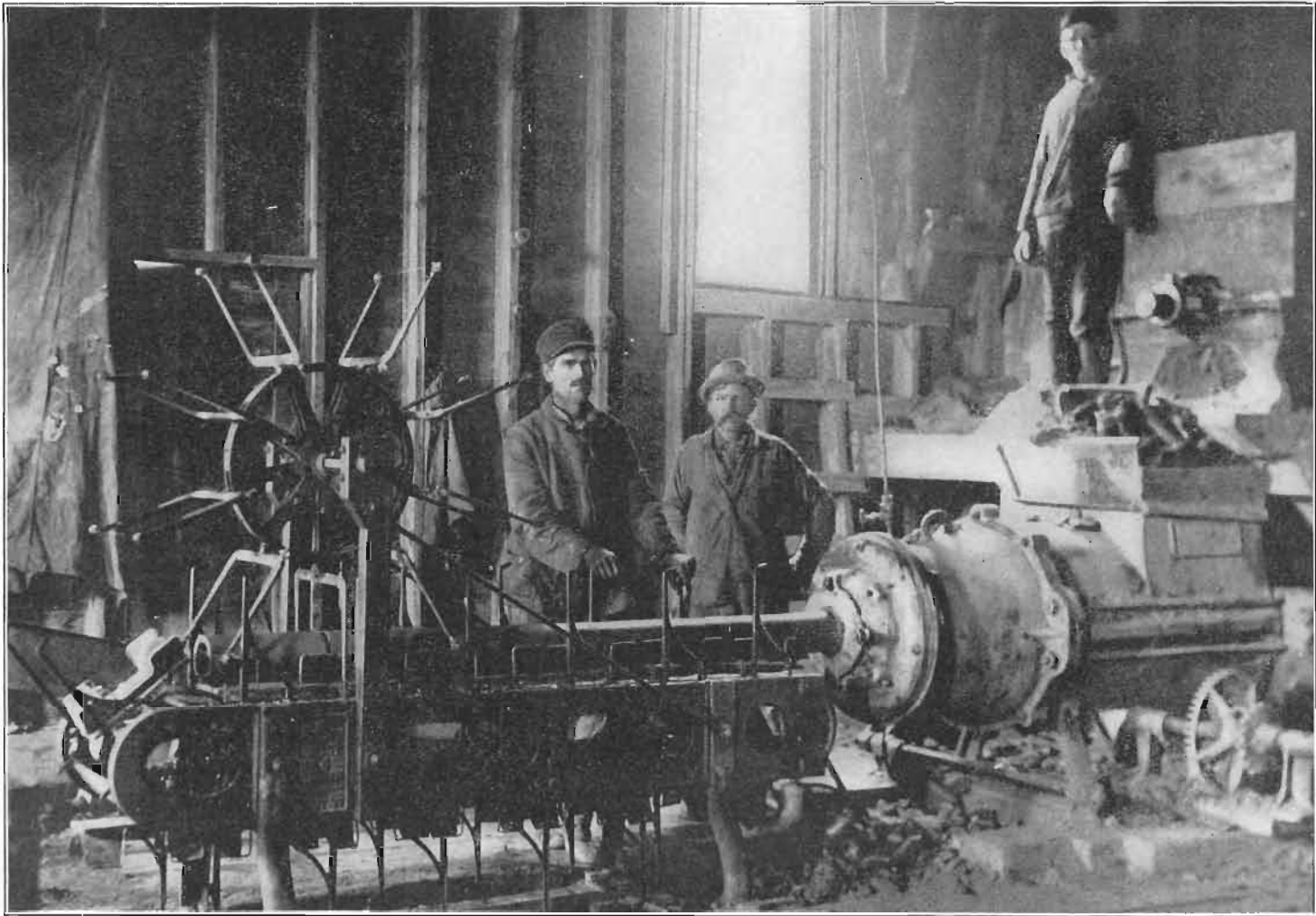

PLATE XXX. Reel cutting table for hollow ware, Lehigh Brick and Tile Company, Lehigh, Iowa.

A seam of cannel coal lies about five feet below the base of the section and is mined and used to burn the ware and furnish heat and power. Hollow ware is the chief manufactured product at present. A chemical analysis was made of number 3 with the following results:

| | |
|-----------------------|-------|
| Silica | 70.20 |
| Alumina | 16.70 |
| Combined water..... | 3.70 |
| <hr/> | |
| Clay and sand..... | 90.60 |
| Iron oxide | 4.00 |
| Lime | 0.28 |
| Magnesia | 0.63 |
| Potash | 1.75 |
| Soda | 1.39 |
| <hr/> | |
| Total fluxes | 8.05 |
| Moisture | 0.53 |
| Sulfur trioxide | 0.82 |

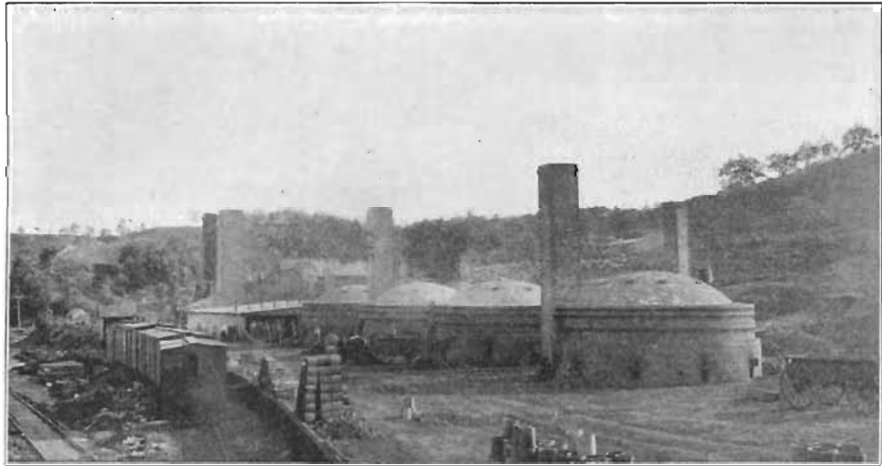

FIG. 65. Plant of the Kalo Brick and Tile Company, Kalo, Iowa.

With the exception of the drift and hard ledges, the entire section is utilized. The pit is above the plant and the clay is transferred from pit to dry pan largely by gravity.

The plant of the Kalo Brick and Tile Company, owned and operated by Schnurr Brothers, is located almost directly west of Coalville, also west of the Des Moines river. The shales developed here are a little higher in the Coal Measures series and are rather more variable. The section is as follows:

| | FEET. |
|---|-------|
| 8. Drift and wash about the level of the "70-foot" terrace | 5 |
| 7. Shale, bluish-gray to yellowish-gray above, jointed below..... | 8 |
| 6. Coal blossom, brown to black and earthy | |
| 5. Shale, sandy, weathers out soft and is of an ash color, contains plant impressions | 8 |
| 4. Sandstone, argillaceous, projecting ledge in places, lower portion often variegated light and dark bands | 2 |
| 3. Coal | ½ |
| 2. Sandstone, argillaceous, when weathered forms a hard ledge; contains leaf impressions..... | 1 |
| 1. Shale, blue-black, pyritic above and gypseous below; pyrite aggregates vary from one-half inch up to three inches, flattened clay-ironstone concretions up to eight inches are also present..... | 4 |

A small fault crosses the face of the pit. The strike is north-east-southwest and the hade is about 50°. The hanging wall is to the northwest, the throw being about two feet. Here as at the Johnson plant, hollow ware is the chief manufactured product. With the exception of the hard ledges, the entire section is used with satisfactory results. A branch of the Minneapolis and Saint Louis railway gives an outlet and nearly the entire output is shipped.

Lehigh rivals Fort Dodge as the most important clay working center in the county. Four factories are doing business on a large scale and all are using very similar raw materials. In addition to the clay used locally, a considerable amount of raw clay is supplied the plants at Fonda and Webster City.

The works of the Lehigh Brick and Tile Company are located on a stub of the Crooked Creek railway. The beds exposed in the pit are as follows:

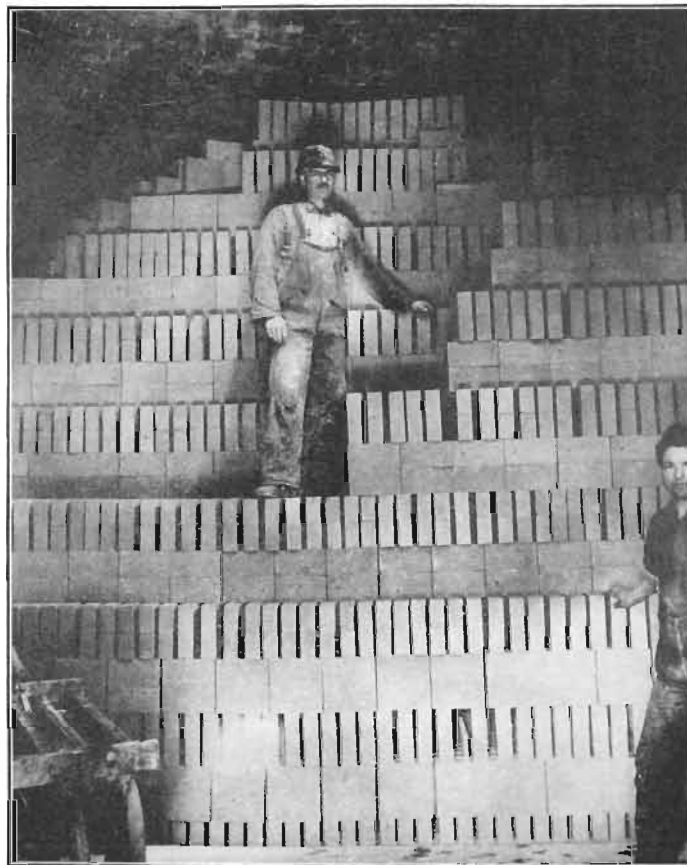
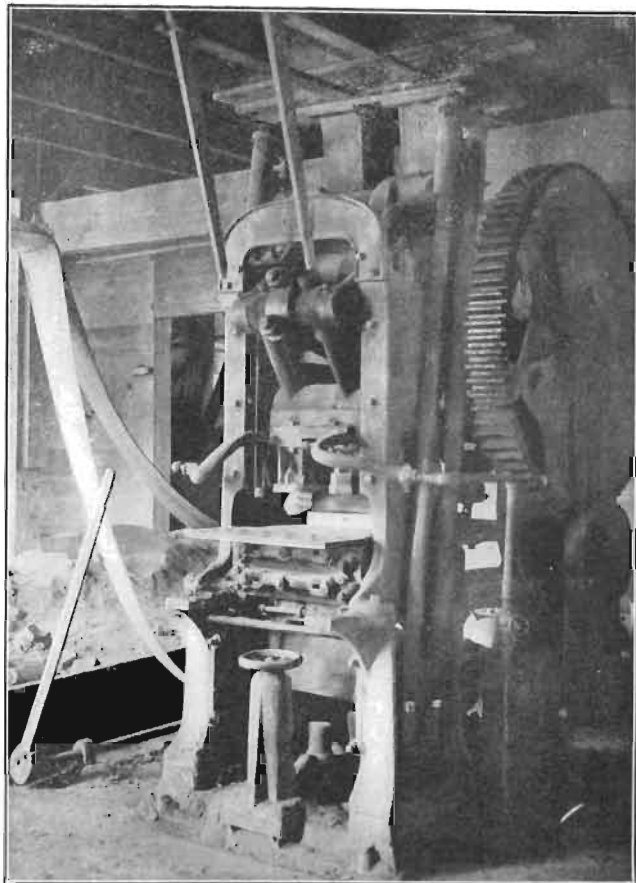

Dry press, shape machine.

PLATE XXXI.

Method of facing dry press brick in a round, down draft kiln.
Corey Pressed Brick and Coal Company, Lehigh, Iowa.

| | FEET. |
|--|-------|
| 7. Drift..... | 4 |
| 6. Shale, clayey, blue..... | 5 |
| 5. Shale, variegated. | 10 |
| 4. Sandstone, friable. | 2 |
| 3. Shale, argillaceous, red and yellow | 3½ |
| 1. Shale, dark, unctuous, exposed..... | 4 |

With the exceptions of portions of the sandstone ledges and the drift, the entire sequence is used.

An average sample from the pit of the Lehigh Clay Works was analyzed and gives some idea of the variation in the composition of the shales of the district. The analysis is as follows:

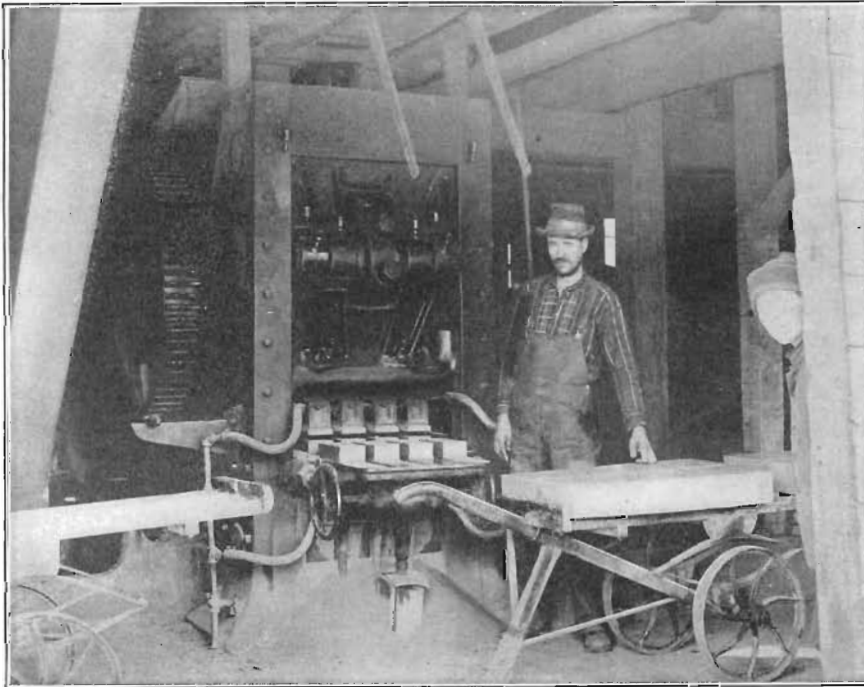

FIG. 66. Boyd four mold, dry press machine; Corey Pressed Brick and Coal Company, Lehigh, Iowa.

| | |
|---------------------|-------|
| Silica..... | 53.08 |
| Alumina..... | 17.71 |
| Combined water..... | 9.30 |
| | <hr/> |
| Clay and sand..... | 80.09 |

| | |
|--|-------|
| Iron oxide..... | 8.64 |
| Lime..... | 4.05 |
| Magnesia..... | 0.94 |
| Potash..... | 1.25 |
| Soda..... | 3.70 |
| | <hr/> |
| Total fluxes..... | 18.58 |
| Insoluble in sulfuric acid and sodium carbonate..... | 71.55 |

The Corey Pressed Brick Company is situated on the north side of Crooked creek, a short distance northeast of the Lehigh Brick and Tile Company and is one of the pioneers in the district. The dry press process only is used and face and fancy brick and special shapes are manufactured with excellent success. Two seams of clay are being developed, the upper seam, occurring above the upper coal vein and averaging about 4 feet in thickness, burns buff; and the lower seam, some 15 feet below and averaging 15 feet in thickness, burns a deep red. Both seams can be developed economically only by mining. Analyses of these clays were made and the results are given below:

| | Red Burning. | Buff Burning. |
|----------------------|--------------|---------------|
| Silica..... | 58.05 | 58.68 |
| Alumina..... | 23.05 | 23.89 |
| Combined water..... | 8.10 | 6.13 |
| | <hr/> | <hr/> |
| Clay and sand..... | 89.17 | 88.70 |
| Iron oxide..... | 3.83 | 3.83 |
| Lime..... | 0.30 | 0.96 |
| Magnesia..... | 2.04 | 1.70 |
| Potash..... | 0.90 | 0.84 |
| Soda..... | 2.04 | 2.19 |
| | <hr/> | <hr/> |
| Total fluxes..... | 9.11 | 9.52 |
| Moisture..... | 0.96 | 0.79 |
| Sulfur trioxide..... | 0.86 | 1.16 |

RATIONAL ANALYSES.

| | | |
|----------------------|--------|--------|
| Clay substance..... | 68.20 | 54.62 |
| Feldspar..... | 5.99 | 11.18 |
| Quartz..... | 25.81 | 23.23 |
| Calcium sulfate..... | | 1.97 |
| | <hr/> | <hr/> |
| | 100.00 | 100.00 |



PLATE XXXI. Pit of the Campbell Brick and Tile Company, Lehigh, Iowa.

The pits of the Campbell brickyard and of the Webster City Brick and Tile Company are located near the point of the hill between the Des Moines river and Crooked creek, about one-half mile below the wagon bridge in Lehigh. The sections exposed in the two pits are practically identical. The beds exposed are as follows:

| | FEET. |
|---|--------|
| 10. Drift and surface wash..... | 1 to 3 |
| 9. Sandstone, clayey, to sandstone shale..... | 5 |
| 8. Coal, impure, to bituminous shale..... | 1+ |
| 7. Fire clay, impure, sandstone and shale..... | 10 |
| 6. Coal, impure, to bituminous shale..... | 1+ |
| 5. Fire clay, somewhat arenaceous..... | 3 |
| 4. Shale, blue, dense, shows slight fissility..... | 15 |
| 3. Coal blossom..... | ½ |
| 2. Shale, clayey..... | 3 |
| 1. Sandstone, argillaceous, soft, almost wholly unindurated, exposed..... | 3 |

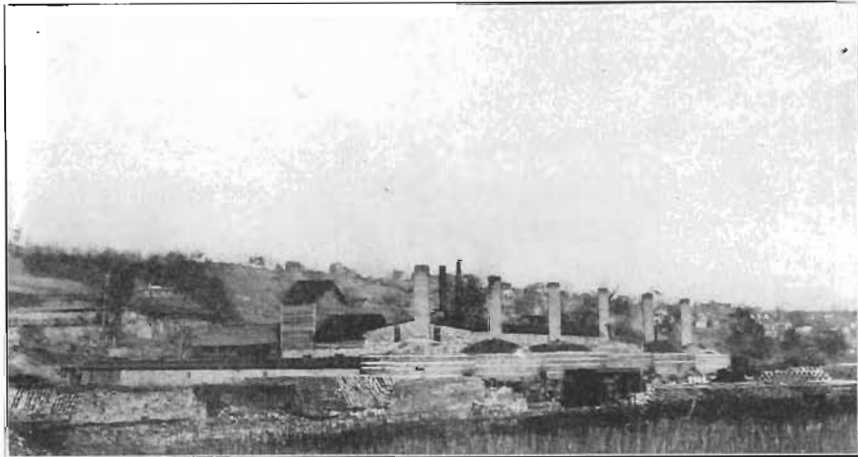

FIG. 67. Plant of the Campbell Brick and Tile Company, Lehigh, Iowa.

With the exception of the sandstone ledges and the larger coal seams, the entire section is utilized. The buff burning shale exposed in the Corey pit is cut out at this point. Number 4 in the section is believed to correspond to the red burning shale at the Corey pit. Drain tile and hollow block are the leading manufactured products.

Chemically the two clays are remarkably similar, and yet one burns a strong red and the other buff. Both give excellent satisfaction as face brick or for inside finish.

The principal manufactured product is hollow ware for all save the Corey plant and almost the entire output of the district is shipped, mainly to the north and northwest. The Chicago and Great Western and the Webster City and Crooked Creek railways afford the rail outlets.

Shales are exposed at numerous other points but the outcrops are not readily accessible at present.

THE CRETACEOUS.

The Cretaceous as represented in Iowa may be divided readily into two divisions, a lower sandstone and shale series, the Dakota, and an upper series of interbedded sandstones, shales and marly limestones. In the upper series the argillaceous beds greatly predominate. Near the top marls and marly limestone of the Niobrara Chalk appear. Rocks referable to the Cretaceous are supposed to cover the larger portion of the northwestern one-third of the state. The limits, however, can not be determined definitely. Cretaceous shale beds are known to exist in Sioux, Plymouth, Woodbury, Sac, Calhoun and Montgomery counties. In most of these some attempts have been made to develop them. It is probable that the shales extend as far east as the Emmet, Calhoun, Guthrie tier of counties, as far south as Montgomery and west to the Missouri bottom lands. The shales have essentially the same range texturally and in composition as those of the Coal Measures but are prevailingly more siliceous and less plastic. The best known deposits are, considered alphabetically by counties:

Calhoun County.—The Cretaceous shales have been developed near Lake City for a number of years. At present but one fac-

tory is in operation, the Lake City Clay Works. The pit is located on Lake creek, a tributary of the Raccoon river, about a mile northwest of the town. The pit section is as follows:

| | FEET. |
|---|-------|
| 5. Drift and wash, the upper portion of which contains much gravel in places | 10 |
| 4. Shale somewhat fissile, grayish-blue to dark blue; when dry, a light gray..... | 4 |
| 3. Sandstone, friable, in three ledges of about equal thickness, indurated in places; the lower ledge highly ferruginous and often contains concretions; the middle layer unindurated and white, top layer stained a very light yellow..... | 2 |
| 2. Shale, clayey, massive, variable texturally and structurally | 7 |
| 1. Sandstone, concretionary, much iron-stained, exposed | 5 |

A short distance north of the pit the sandstone members become very prominent and constitute the major portion of the section. Near the base of the section a red stratum appears and is associated with an almost pure white putty clay. The sandstone shows various stages of induration, and clay balls and lenses occur throughout the entire mass. A light shale comes in above this sandstone. Good shale sections are reported to occur along the Raccoon river three or four miles to the southwest. The same shale also occurs near Grant City, in Sac county. An analysis of the principal shale bed was made with the following results:

| | |
|---|-------|
| Silica | 74.83 |
| Alumina..... | 12.20 |
| Combined water..... | 5.15 |
| | <hr/> |
| Clay and sand | 92.18 |
| Iron oxide..... | 1.24 |
| Lime..... | 2.22 |
| Magnesia..... | 1.08 |
| Potash..... | .32 |
| Soda | 1.08 |
| | <hr/> |
| Total fluxes | 5.94 |
| Moisture, carbon dioxide and sulfur trioxide..... | 2.58 |

RATIONAL ANALYSIS.

| | |
|----------------------|--------|
| Clay substance..... | 42.00 |
| Feldspar..... | 8.44 |
| Quartz..... | 46.16 |
| Calcium sulfate..... | 3.40 |
| | 100.00 |

A casual inspection of the analysis will show that the clay is highly siliceous, comparatively low in alumina and low in the fluxing constituents. It is also low in iron and burns a light color, and shrinks but little during the process of drying and burning. Where it has been used the practice has been to mix with it the surface wash and alluvial material which run much higher in iron and give a good color. Clay shales have not been utilized at any other point in the county.

Montgomery County.—The Cretaceous deposits represented in the county are usually arenaceous and have been referred tentatively to the Dakota stage. Although sandstones prevail near the top of the series in certain places certain argillaceous deposits are of importance. The clay beds are somewhat irregularly distributed and are not persistent. The most important clays of this age known in the county are found near Red Oak. The beds have been developed for a number of years by the Red Oak Pottery Company.

The pit section is as follows:

| | FEET. | INCHES. |
|---|-------|---------|
| 11. Loess, impure in lower portion..... | 6 | 6 |
| 10. Sandstone, light yellow, soft..... | 3 | |
| 9. Shale, light gray, used for pottery..... | | 11 |
| 8. Sandstone, white to yellow..... | 1 | 6 |
| 7. Shale, light gray, for pottery..... | 2 | |
| 6. Shale, gray, siliceous; for fire brick..... | 1 | 1 |
| 5. Shale, dark to light gray; for pottery..... | 1 | 6 |
| 4. Shale, gray, siliceous; for fire brick..... | | 2 |
| 3. Shale, light to dark gray; for pottery..... | 2 | 2 |
| 2. Shale, grayish; for fire brick..... | | 6 |
| 1. Shale, siliceous, gray, impure, exposed..... | | 6 |

The principal shale in the pit attains a thickness in some places of 15 feet and apparently rests unconformably upon a very siliceous shale. Near the east end of the pit it is replaced by friable sandstone. Loess covers the entire section. A sample of the purest clay was analyzed and the results are given herewith:

| | |
|----------------------|-------|
| Silica | 69.75 |
| Alumina | 18.68 |
| Combined water | 3.85 |
| Clay and sand | 92.28 |
| Iron oxide..... | 1.94 |
| Lime | 1.07 |
| Magnesia..... | .95 |
| Potash..... | 2.32 |
| Soda..... | .64 |
| Total fluxes..... | 6.92 |
| Moisture..... | 1.33 |

White stoneware is manufactured from the best grades and a few fire brick have been made which give fair satisfaction. It is believed that certain layers if freed from impurities by washing could be made into a superior quality of glass pots and crucibles. At this time the Cretaceous clays have not been developed at any other point in the county.

Plymouth County.—The shale clays in Plymouth county are not very accessible at the present time for open pit work. They are present in considerable quantity and of good quality within easy mining distance. A representative section may be viewed near the site of the old Crill mill on section 32, in Sioux township. The beds of indurated rocks visible at this point are as follows:

| | FEET. |
|--|-------|
| 6. Limestone, thin, leafy texture, fossiliferous..... | 90 |
| 5. Shale, buff, sandy, with layers of sandstone and ferruginous concretions..... | 30 |
| 4. Shale, dark blue to drab, fine-grained, argillaceous | 10 |
| 3. Sandstone, fine-grained, calcareous, light buff to white | 15 |
| 2. Lignite | 1½ |
| 1. Fire clay, white to light gray, only slightly exposed, found in digging | 6 |

The fire clay contains very little grit, is quite plastic and apparently would be easily worked. The sandstone above the lignite seam would afford a good roof and the bed would yield readily to mining operations. An analysis of the fire clay was made with the following results:

| | |
|---------------------|-------|
| Silica | 67.42 |
| Alumina | 19.43 |
| Combined water..... | 5.59 |
| | <hr/> |
| Clay and sand | 92.94 |
| Iron oxide..... | 2.39 |
| Lime | 0.55 |
| Magnesia | 0.25 |
| Potash | 0.25 |
| Soda | 0.58 |
| | <hr/> |
| Total fluxes..... | 4.47 |
| Moisture..... | 2.98 |

The fire clay compares favorably in composition with some of the standard fire clays of the country. Numbers 4 and 5 in the section would also be available and could be used separately or by blending with number 1, and the possibilities of manufacture be increased greatly. Also the surface clays could be brought into service. At present no serious attempt has been made to develop the shales, although similar beds are used extensively at Sioux City and Sargents Bluff.

Pottawattamie County.—Shales and sandstone of Cretaceous age are known to cover portions of Pottawattamie county. The arenaceous beds predominate in the outcrops known. Along the western line of the northeast quarter of section 36, in Wright township, there is a long escarpment of sandstone running nearly due north and south for more than a quarter of a mile, facing the river and forming its western bluff. South of the escarpment, near the north line of section 1, in Waveland township, the sandstone exposed in the river rises only a few feet above the water. On top of the sandstone rests forty feet of light gray clay

or shale in which there are occasional seams of fine sand. The shale is variable in color, ranging from light to dark, and weathers yellow. In addition to the sand layers, it contains occasional carbonaceous seams and concretions of siderite. The clay is known to outcrop at other points and is believed to be suitable for all of the grades of common brick and hollow ware. No attempts have been made to develop it commercially.

Sac County.—The clay shales exposed along the Raccoon river and Lake creek in Calhoun county continue into Sac county and



FIG. 68. Clay shales with concretions of clay-ironstone. Sec. 36, Wright township, Pottawattamie county, Iowa.

appear in the bluffs near Grant City. They appear to be of excellent quality, but little has been done toward their utilization commercially.

Sioux County.—Shales presumably belonging to the Benton stage of the Cretaceous appear in the railway cut about four miles south of Hawarden. The section is given below.

| | FEET. |
|--|-------|
| 2. Shale, drab to blue, argillaceous in part, containing numerous crystals of gypsum | 25 |
| 1. Limestone, fossiliferous, thinly bedded, with chalky layers..... | 20 |



FIG. 9. Benton shales exposed in railway cut three miles south of Hawarden, in Sioux county, Iowa.

Formerly the shales were used in the manufacture of brick and common hollow ware with somewhat indifferent results. The plant burnt down some years ago and has not been rebuilt. So far as known the shales do not present any other outcrops readily accessible in the county, although they are undoubtedly within easy mining range over a considerable area.

Woodbury County.—Shale beds referable to the Cretaceous are abundantly exposed in the western portion of the county, especially in the vicinity of Sargents Bluff and Sioux City. At both points they have been developed extensively in the manufacture of clay goods. In general the shales are highly siliceous, and comparatively low in clay substance and the fluxes. As a consequence they are not so well adapted to the manufacture of hollow ware as the shales of the Coal Measures and Devonian.

They are especially adapted to the manufacture of shapes because of their low shrinkage and would give good results when treated by the dry press process. At present the stiff mud process only is used.

At Sargents Bluff, about seven miles below Sioux City, one of the standard sections of the county may be viewed. The sequence of beds is as follows:

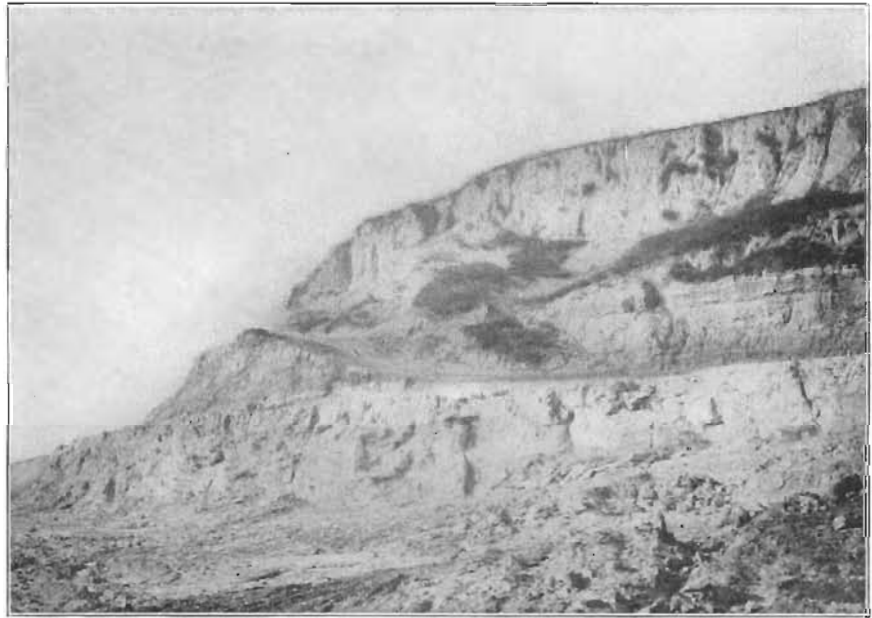

FIG 70. Pit of Holman and Brother Brick Plant, Sargents Bluff, Iowa.

| | FEET. |
|---|-------|
| 5. Loess, thickening back from the river and forming bold bluffs, 100 to 150 feet high | 40 |
| 4. Sandstone, fine-grained, light buff to white above, coarse, orange-yellow below | 25 |
| 3. Lignite, more or less earthy, usually of a dark purplish hue..... | 1½ |
| 2. Shale, variegated, brilliant orange to dark olive green, with interstratified beds of fine white sand and thin bands of ferruginous concretions containing plant remains | 18 |
| 1. Shale, sandy, reddish, becoming drab to orange below, and containing large ferruginous sandy masses with plant remains..... | 25 |

The shale members have been developed on a large scale for a number of years. At present two plants are in operation, C. J. Holman and Brother, and C. W. Ritz. The former yard is the pioneer in the district. The Holman pit shows the following details.

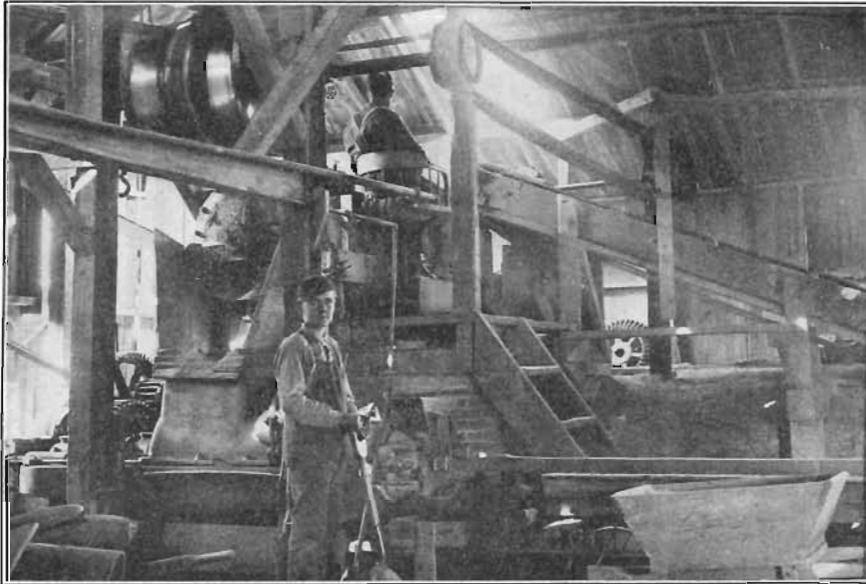

FIG. 71. Interior view of machinery building, Holman and Brother Brick Plant, Sargents Bluff, Iowa

| | FEET. |
|--|-------|
| 7. Loess of variable thickness up to..... | 40 |
| 6. Sandstone, unevenly indurated (exposed)..... | 10 |
| 5. Shale, lignitic to argillaceous..... | 1½ |
| 4. Shale, argillaceous to sandy..... | 5 |
| 3. Shale, unctuous, dark to light gray in color..... | 8 |
| 2. Shale, light colored, somewhat arenaceous..... | 6 |
| 1. Shale, buff to yellow and gray..... | 16 |

All of the beds are usable save the sandstone and lignite seam. The loess, however, is not generally used, although it would undoubtedly make a good quality of builders either alone or blended with the clay shales. The sandstone is usually quite friable and breaks down easily when exposed to the weather. It

furnishes an abundant supply of clean sand for sanding the ware in the kilns. Analyses were made of the principal shale seam and of a seam of fire clay. The results are given below:

| | | |
|--|-------|-------|
| Silica | 71.63 | 75.85 |
| Alumina | 14.17 | 10.73 |
| Combined water | 5.16 | 6.38 |
| | <hr/> | <hr/> |
| Clay and sand | 90.96 | 92.96 |
| Iron oxide | 2.39 | 1.43 |
| Lime..... | 2.15 | 1.00 |
| Magnesia | .86 | .49 |
| Potash | .50 | .24 |
| Soda | 1.15 | .70 |
| | <hr/> | <hr/> |
| Total fluxes | 7.05 | 3.86 |
| Moisture, sulfur trioxide and carbon dioxide.. | 2.30 | 3.18 |

RATIONAL ANALYSES.

| | | |
|---------------------|--------|--------|
| Clay substance..... | 49.69 | 41.28 |
| Feldspar | 3.13 | 6.55 |
| Quartz | 47.18 | 52.17 |
| | <hr/> | <hr/> |
| Total | 100.00 | 100.00 |

Both clays are highly siliceous and comparatively low in fluxes. In fact the entire assemblage of beds are somewhat arenaceous and work "short." The ware, when properly burnt, is strong and resists the weather well. Common and face brick, paving brick and sidewalk brick and block are the chief manufactured products. The sidewalk block and brick have gained great favor and the demand is growing rapidly.

The ware shrinks but little in drying and burning. The Holman type of kiln is used and the brick are successfully burnt when set 48 brick high.

The Ritz pit presents some local variations but the beds worked belong to essentially the same horizons as those just described.

At North Riverside, a suburb of Sioux City, the Cretaceous shales are being developed extensively. Two up-to-date plants

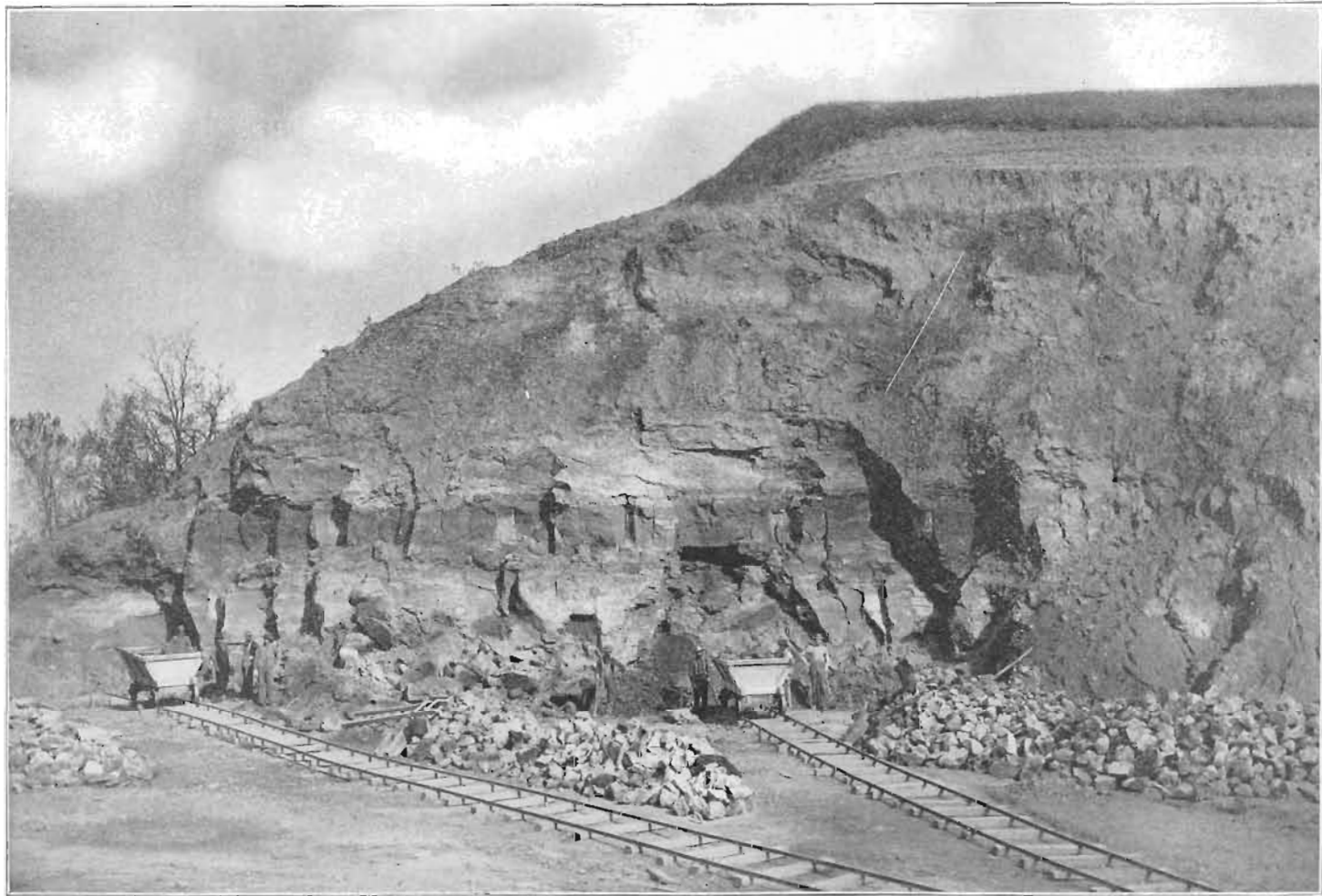

PLATE XXXIII. Pit of the Sioux City Brick and Tile Company at North Riverside, Sioux City, Iowa.

are in operation, the Sioux Paving Brick Company, successors to the old Sioux Paving Brick Company and the Lower Brick Company, and the Sioux City Brick and Tile Works. The beds developed at the various plants in this vicinity are not very different and are essentially stratigraphic equivalents. The pit of the Sioux Paving Brick Company is perhaps the most extensive and shows the greatest diversity. The details are given below:

| | FEET. |
|--|-------|
| 13. Loess, up to..... | 10 |
| 12. Shale, very arenaceous, with gypsum in veins..... | 14 |
| 11. Shale, light to drab-gray, in part sandy, with gyp- seous seams..... | 15 |
| 10. Shale, with impure limestone in irregular bowlder- like masses..... | 3 |
| 9. Shale and sand, ferruginous, in alternating layers.... | 4 |
| 8. Shale, gray, non-siliceous..... | 10 |
| 7. Shale, grayish to drab, with four-inch rock ledges about the middle..... | 6 |
| 6. Sandstone, calcareous, in part shaly..... | 4 |
| 5. Shale, gray, fissile..... | 2½ |
| 4. Shale, gray, very finely siliceous, with ferruginous masses near middle, also in upper part..... | 5½ |
| 2. Sandstone, light colored..... | 7 |
| 1. Shale..... | 1 |

Nearly all of the beds are used save the hard ledges and strongly calcareous bands. For ordinary builders the loess can be used freely. Some attempts have been made to manufacture vitrified brick, but with rather indifferent success.

About one-half mile south is the pit of the old Northwestern Sewer Pipe and Tile Company. The pit shows some variations and is given below:

| | FEET. |
|--|-------|
| 7. Shale, gray to white, siliceous..... | 15 |
| 6. Lignite, impure..... | 1 |
| 5. Sandstone, marly, white..... | 2½ |
| 4. Shale, gray to white, with ferruginous colorings; also layers of siliceous bowlders..... | 12 |
| 3. Shale, drab to white, arenaceous..... | 2 |
| 2. Sandstone, white to red..... | 7 |
| 1. Shale, gray, sandy, especially below; exposed..... | 7 |

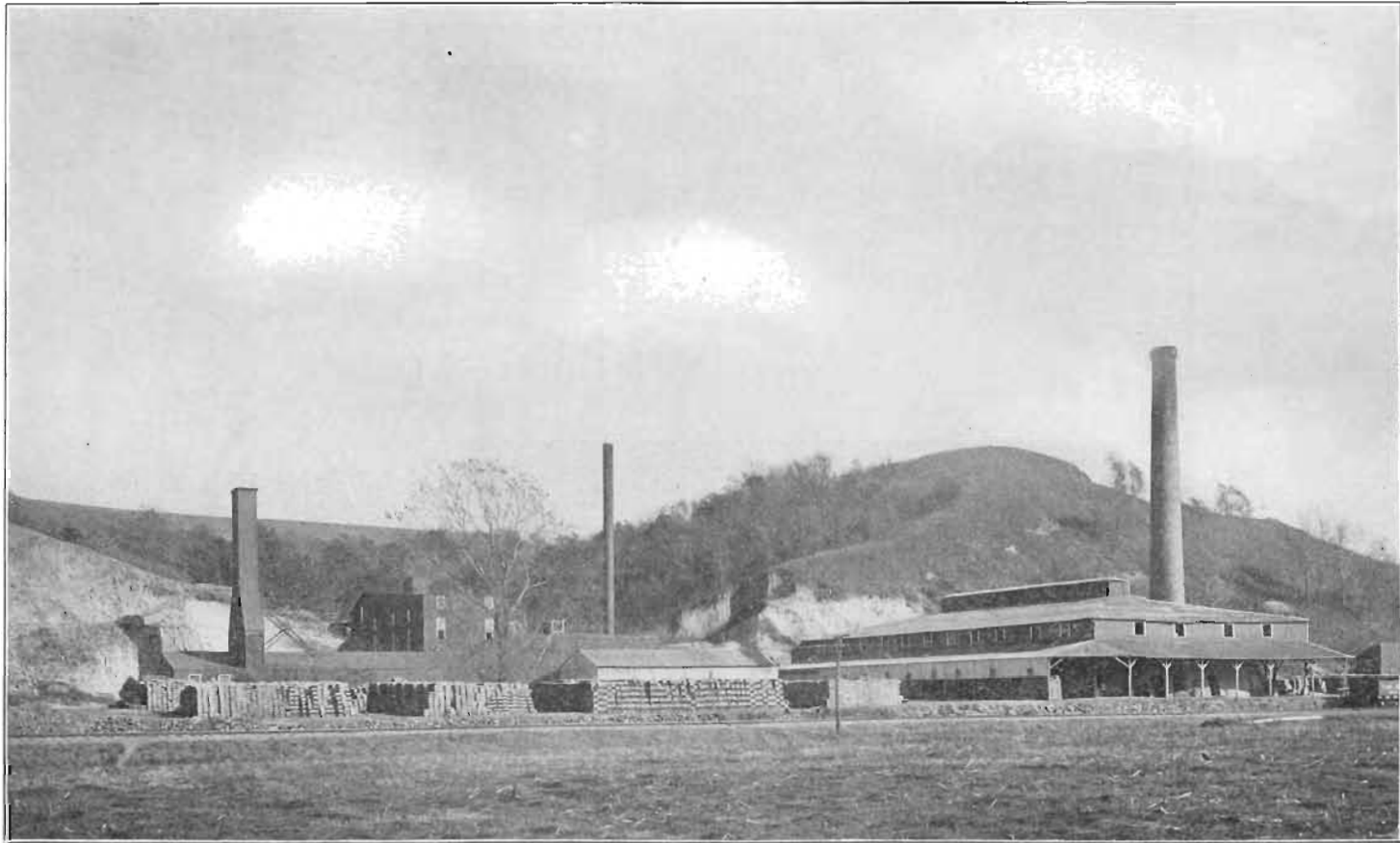

PLATE XXXIV. Plant of the Sioux City Brick and Tile Company at North Riverside, Sioux City, Iowa.

Formerly sewer pipe was manufactured, but no pipe has been made for some years.

The manufactured products comprise common building brick, paving brick and fire brick and sidewalk brick. The shale blended appears to be especially adapted to the manufacture of first-class sidewalk brick. The process of manufacture consists of running the ware stiff mud and then passing the end cut brick through a repress in which they are shaped and a pattern stamped upon them.

The Sioux City Brick and Tile Company has recently installed a modern plant between the above mentioned plants and are doing business on a large scale. Their pit is shown in the accompanying cut. In addition to common builders and face brick, a large number of tile and building block are produced annually. Most of the ware is burnt in a Haigh continuous kiln, which gives eminent satisfaction. Here, as at Sargents Bluff, the shales are highly siliceous and but little loss is experienced in drying and burning. Higher temperatures are required to secure a good burn than for any other series of shales in the state.

Some of the shale and clay seams are highly plastic, fairly free from impurities, yield readily to the potter's art and burn a satisfactory color. Potteries have been in operation from time to time both at Sioux City and Sargents Bluff but none are in business at present.

Shale crops continue northward along the Big Sioux but become more and more intimately associated with calcareous and arenaceous beds so that their extensive development would only be possible by drifting or shafting. Nothing has been done toward their utilization in the manufacture of clay goods at any other point in the county.

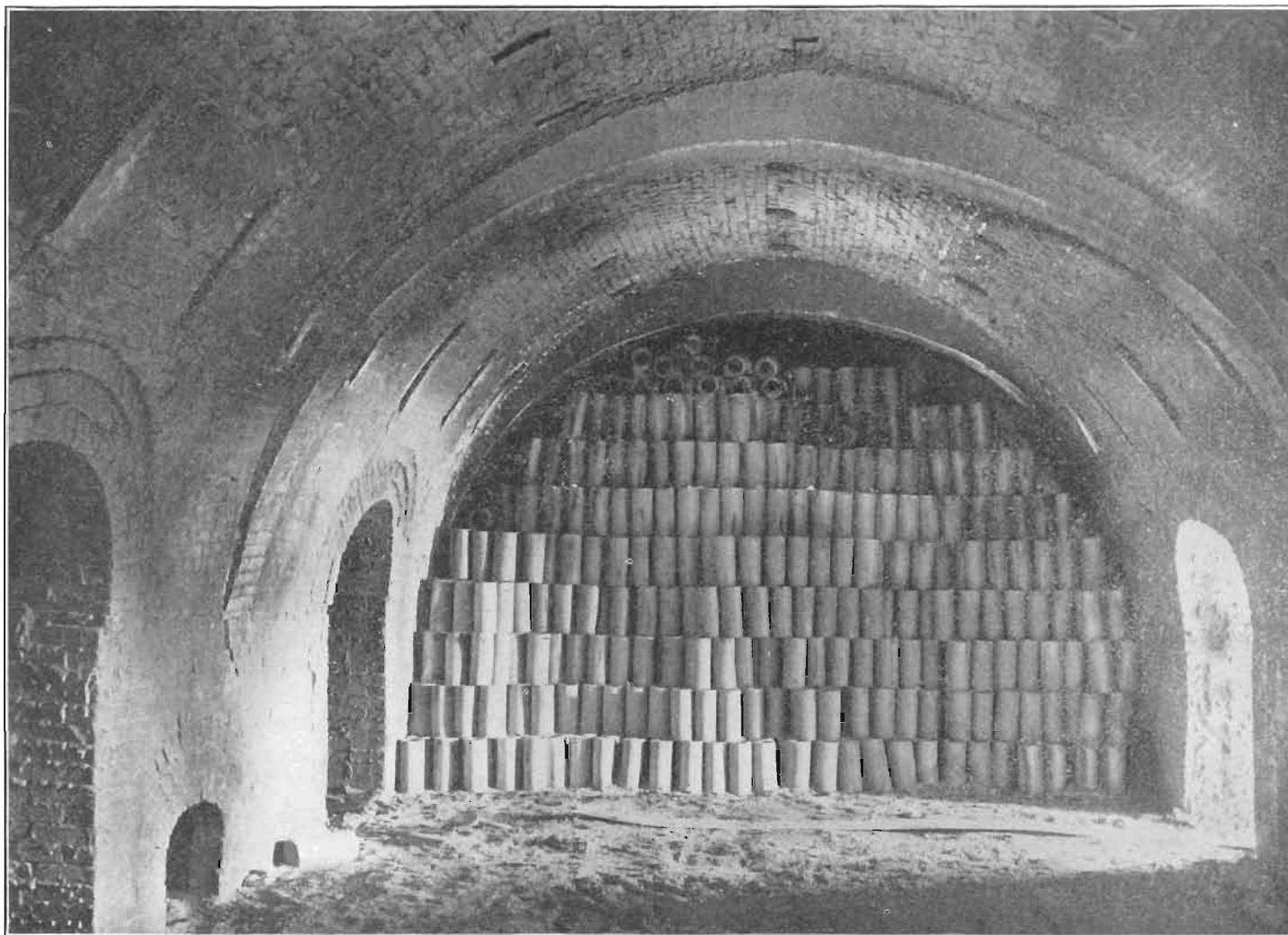

PLATE XXXV. Interior view of Haigh continuous kiln showing method of setting hollow ware. Sioux City Brick and Tile Company, Sioux City, Iowa



FIG. 72 Interior view of Haigh continuous kiln showing method of setting brick; Sioux City Brick and Tile Company, Sioux City Iowa.

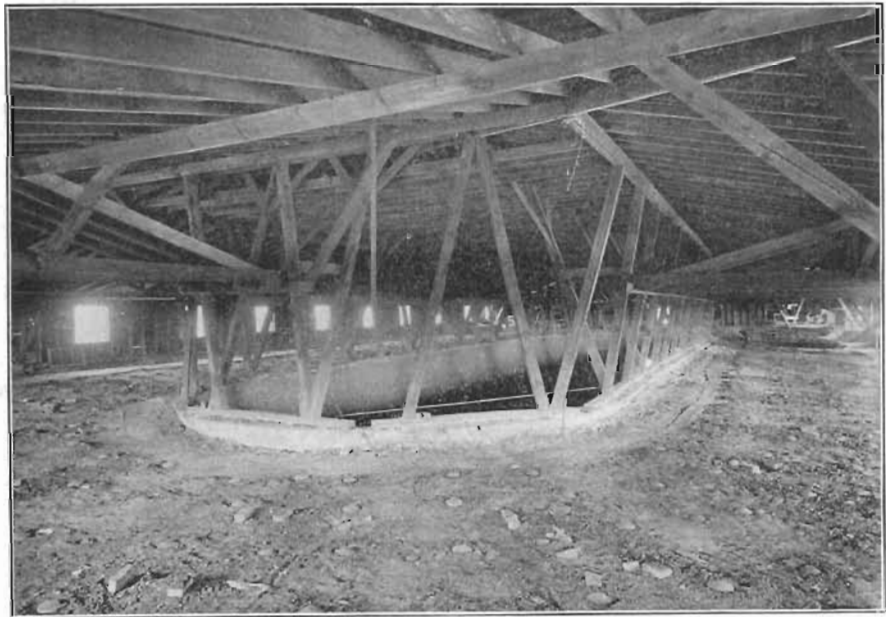

FIG. 73. Top view of Haigh continuous kiln showing arrangement of fire holes and open court.

The Pleistocene

With the exception of a small area in the northeast corner of the state the older rocks are covered by a thick mantle of glacial debris which varies from total absence up to two and even three or four hundred feet in thickness. Only the larger streams and their immediate tributaries have cut through the drift. The detailed features of the landscape are moulded in it. Only the larger features are in any way the result of the older rocks. The drift is composed of a most heterogeneous series of materials comprising boulder beds, gravel trains and the more or less sorted over-wash. Intimately associated with the drift sheets are the massive structureless deposits of loess. The loess is composed of fairly well sorted finer sands, silts and clays. It covers about two-thirds of the superficial area of the state and affords an inexhaustible supply of raw material ready prepared for the clay worker. It varies from a thin veneer to deposits many feet in thickness. Of the drift sheets themselves but little has been done toward their utilization in the clay working industries. The greater portion of the various drift sheets contains numerous pebbles and boulders, many of which are calcareous in character and make the use of drift expensive or impossible to the brick-maker. In addition to the pebbles and boulders, the unaltered drift contains a high percentage of lime, both in the form of concretions and in the widely disseminated form throughout their entire mass. Lime concretions must be eliminated or finely pulverized in order that the clay may be used safely. Many of the drift clays, even when fairly free from the deleterious impurities mentioned, still fail to give satisfaction on account of excessive shrinkage and consequent great loss due to checking in drying and burning. However, several of the drift sheets present deposits which have been slumped or washed naturally through the processes of weathering, transportation and sedimen-

tation and have been partially prepared for the brick maker. Such deposits occur about some of the present or recent lake beds, along ravines and draws and on second bottom land, merging insensibly into alluvial deposits, and are used to a limited extent and give fairly satisfactory results.

In Iowa five drift sheets are recognizable and will be discussed in the order of their age. All save one are shown on the accompanying map.

PRE-KANSAN OR ALBERTAN.

The glacial deposits supposed to be the equivalent of the Albertan of the Canadian geologists, have been observed at a number of points in the state. The best known sections may be viewed at Afton Junction in Union county, at Albion mills in Marshall county and in the cut along the Great Western railway near Oelwein in Fayette county. The Albertan is not known to appear at the surface, save in natural or artificial cuts, and is of no practical importance to the clay worker. It has been observed at numerous other points and is usually separated from the overlying drift sheet by peat beds, forest remains, old soils and gravel beds.

THE KANSAN.

The ice invasion which produced the Kansan drift marks the extreme ice advance for the Mississippi Valley. It is the only glacial sheet which was known to cross the Missouri river into Kansas and hence the name. It is not only the most extensive areally in Iowa but also averages the thickest. A glance at the map will show that it extended over practically the whole of the state and is at present the superficial drift sheet of more than half of the state. It ranges in thickness from zero to more than 100 feet. In places it is believed to reach a maximum thickness of nearly 300 feet and averages nearly 100 feet for the entire

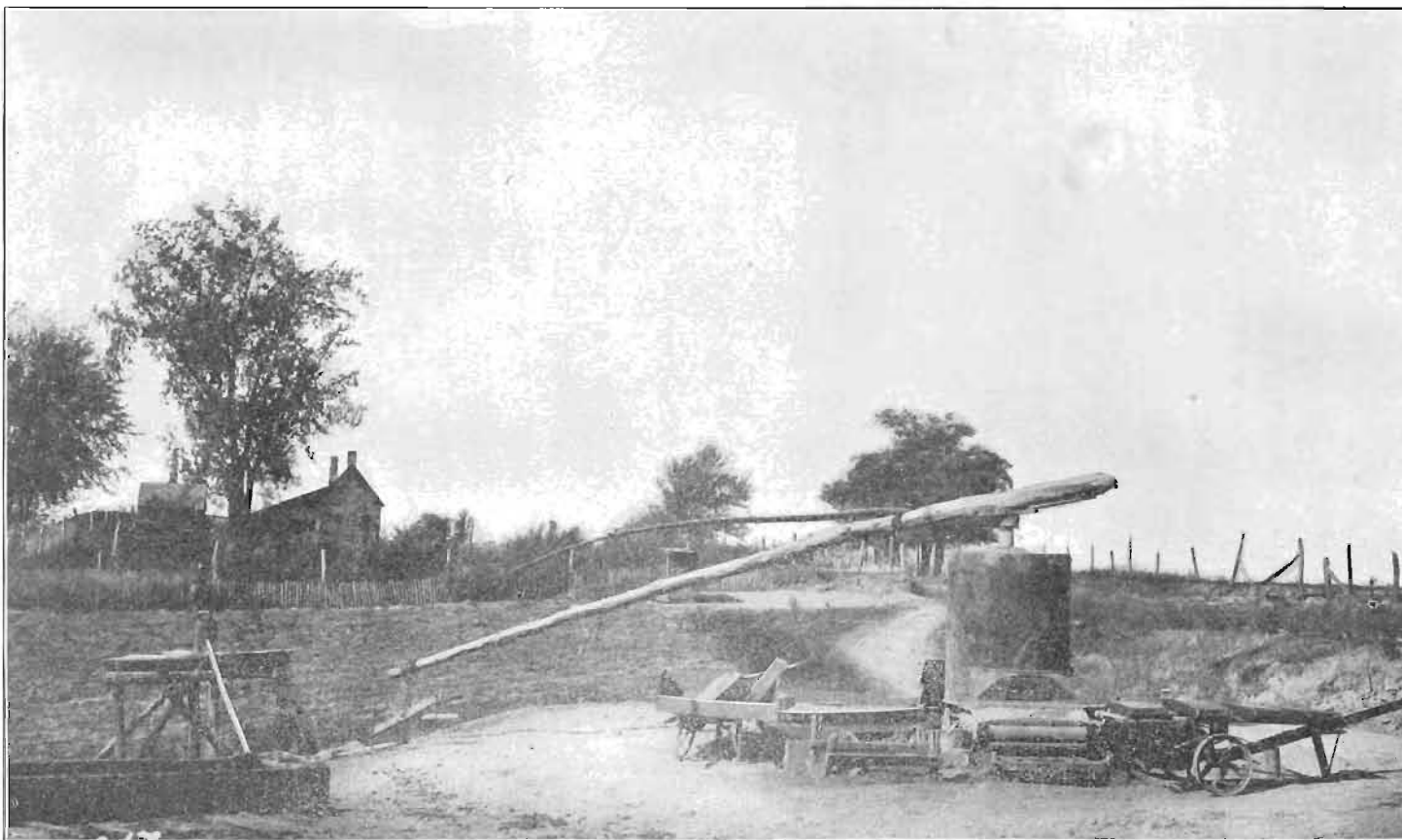

PLATE XXXVI. Plant near Moravia, Iowa, showing method of manufacturing surface clays.

state. The upper portion of the Kansan is more or less completely oxidized to a red-brown or yellow-brown and is thoroughly leached of its lime in the widely disseminated form and as concretions. It may still contain some lime pebbles and bowlders. The thickness of the oxidized portion varies from a few feet to 20 or 30 feet and when fairly free from gravel and bowlders can be used for the manufacture of common brick and tile. Some attempts have been made to utilize the unoxidized Kansan drift, with unsatisfactory results. Topographically, the Kansan drift area is characterized by being much stream dissected. The drainage lines are mature, and generally the small tributaries have almost perfectly drained the divides. No ponds or lakes are to be found away from the immediate vicinity of the larger streams. The land comprised in this area is considerably broken.

THE ILLINOIAN.

The drift produced by the Illinoian ice invasion is limited to a comparatively small area and constitutes considerable portions of Scott, Muscatine, Louisa, Des Moines and Lee counties. The drift materials are not very different from those which constitute the Kansan and possess the same advantages and the same disadvantages when viewed from the standpoint of the clay worker. They have not been developed to any extent in Iowa, yet the oxidized, leached portion could undoubtedly be successfully used in the manufacture of the common clay wares.

THE IOWAN.

The Iowan drift occupies about 10,000 square miles of the northeast quarter of the state. It is bounded on the west by the Altamont moraine, which passes in a southerly direction through the western portions of Worth, Cerro Gordo and Franklin counties, east of the middle of Hardin county, and on the south by a series of finger-like loops, the various fingers extending into

Poweshiek, Johnson, Cedar, Scott and Clinton counties. The eastern boundaries are also irregular, lobes extending into Jones, Dubuque and Clayton counties, a more or less even line across the northwest corner of Fayette, southwest corner of Winneshiek, cutting the northeast corner of Howard county to the state line. The Iowan drift is characterized by large numbers of red and gray granite bowlders, many of which are of gigantic size. The finer materials rarely exceed 10 or 15 feet in thickness and when unweathered contain a considerable amount of lime. The weathered portion of the Iowan and the wash from the Iowan is often sufficiently free from lime to be serviceable in the clay industries. It has not been developed to any extent along those lines. Topographically, the Iowa drift surface is but slightly broken and presents an even, monotonous plain known as the "Iowan drift plain."

Delaware County.—The Iowan drift covers the major portion of the county and in places is sufficiently free from lime and other impurities to be used in the manufacture of common brick and tile. At Manchester the brickyard of C. H. Mattox, located on top of the hill in the eastern part of the city, has been operating for more than one-third of a century. The clay bank developed shows the following materials:

| | FEET. |
|--|-------|
| 3. Soil, very sandy in parts | 1 |
| 2. Clay, sandy and pebbly, yellow..... | 3 |
| 1. Clay, yellow to brown..... | 6 |

Number 1 contains sharp sand disseminated throughout and in pockets, and occasionally a pebble. Below the base of the cut there is about sixty-five feet of blue drift clay; limey in the upper portion. The Niagara limestone lies below the heavy till. Common brick only are manufactured at the present time.

THE LOESS.

Beyond the borders and overlapping some of the drift sheets, a fine, evenly sorted material has been deposited. Such deposits

appear to be almost structureless and while easily eroded or removed by running water, possess the property of maintaining vertical embankments, even assuming the magnitude of cliffs as may be seen facing the Missouri river. When examined closely, it is found that the materials composing such deposits are clay, silt and fine sand, exactly identical with those materials found in the unassorted boulder clays which preceded them. Sometimes one



FIG. 74. Pit of the Muscatine Pressed Brick Company, Muscatine, Iowa.

and sometimes another of these constituents predominate. As a general rule there is a gradual increase in the sand element from the surface downward, the deposit often terminating in a bed of fine sand. This material is known as the loess. The distribution of the loess appears to be independent of the local topography. It is usually thickest near the brow of the hills and bluffs, along the principal water courses, especially those bluffs which face

west, and thins gradually toward the divides. The deposits also become less arenaceous in character toward the water sheds. The loess often contains the well preserved remains of arid region gastropods, root casts and lime concretions. Some of the last assume curious and fantastic shapes, the Germans calling them Loess-Püppchen and Loess-Männchen because of their fancied resemblance to dolls. The lime balls when present usually occur in a zone some feet from the surface and can generally be avoided when the clay is used in the clay industries. The loess covers more than one-half of the surface of the state, and varies from



FIG. 75. Brick machine used in the manufacture of soft mud brick. William Samuels yard, Muscatine, Iowa.

total absence to twenty or thirty feet and even exceeds one hundred feet in thickness along the Missouri river. It affords an exhaustless supply of material suitable for the manufacture of brick by the soft mud, stiff mud or dry press process, drain tile and burnt clay ballast. It is the cheapest of clays to work, requiring neither dynamite nor pick in the pit and often receiving no pre-

liminary grinding, crushing or pugging before being introduced to the brick machine. A large majority of the brick plants in the state draw their raw material from the loess.

The Red Clay.—Several fairly distinct types of loess have been recognized in Iowa, but all are believed to be genetically related. The most important deposits are known to be younger than the Kansan drift and are older than the Wisconsin. Perhaps the oldest type occurs in the southwestern portion of the state and is known as the red clay or “gumbo” and has been quite fully described by Udden in his report on the Geology of Pottawattamie County.* The red clay quite closely resembles physically the younger phase of loess which covers it, but is less porous, and has been thoroughly oxidized and leached. On drying it resembles a joint clay, breaking into a number of angular fragments. Occasionally, but not commonly, it contains drift pebbles in the lower portion. Its impervious character appears to be due to a slightly higher percentage of clay particles but more especially to the interstitial deposition of fine ferruginous material through the agency of the ground water. So far as known it is free from organic remains and its origin and taxonomic relations are not well understood. Exposures are not common and the red clay has not been developed in the clay industries. The close relationship between the red clay and the younger loess is clearly shown by an inspection of the following table, which is taken from Professor Udden’s report. It is estimated that the loess constitutes 95 per cent of the red clay.

*Iowa Geological Survey, Vol. XI. pp. 255 to 258.

The Gumbo.—In the southern portion of the state, away from the great rivers, the gumbo is gray to drab in color, and while believed to belong stratigraphically with the loess, it is more plastic and less porous than the loess which covers it. When damp, but not wet, it presents a mealy appearance which is quite deceptive as to its real character. As in the case of the red clay, it rarely carries pebbles. Small lime balls are often present, but are usually not so large or so numerous as those in the loess. The inland type of gumbo rests directly on the ferretto zone of the Kansan and attains a thickness of ten feet. It is possible that the red clay and the inland gumbo may be phases of the same deposits.

Burnt Clay Ballast.—The red clay and gumbo are not of practical interest to the brick maker because of their excessive shrinkage. The gumbo, with the close-textured loess which covers it in a number of counties in southern Iowa, has been developed quite extensively at a number of points for the manufacture of burnt clay ballast. Two companies are actively engaged in this work at the present time. The Davy Burnt Clay Ballast Company, whose home office is in Kenosha, Wisconsin, and the Western Ballast Company, with home office at Aurora, Illinois. The first company has pits at Selection and Corning, while the second is operating at Nodaway, Adams county. The methods used are essentially the same. The material used ordinarily consists of the superficial loess with the gumbo below. Occasionally an alluvial clay is used, as was the case near Cuba, in Iowa county. Whatever the material used certain physical properties are essential to insure satisfactory results. The excessive shrinkage mentioned which is fatal to success in the manufacture of ordinary clay goods is not only a desirable quality but is essential to the economic manufacture of burnt clay ballast. The extraordinary shrinkage causes the gumbo masses scooped out by the ballast machine to partially disintegrate under fire, at once facilitating an

equable distribution of heat, which makes uniformity in burning possible and prevents the overheating and consequently the production of unwieldy glassy bowlders and clinkers. The product when successfully burned consists of fragments fairly uniform in size and requires no further treatment preparatory to use. A second quality, while not so important as the first, contributes

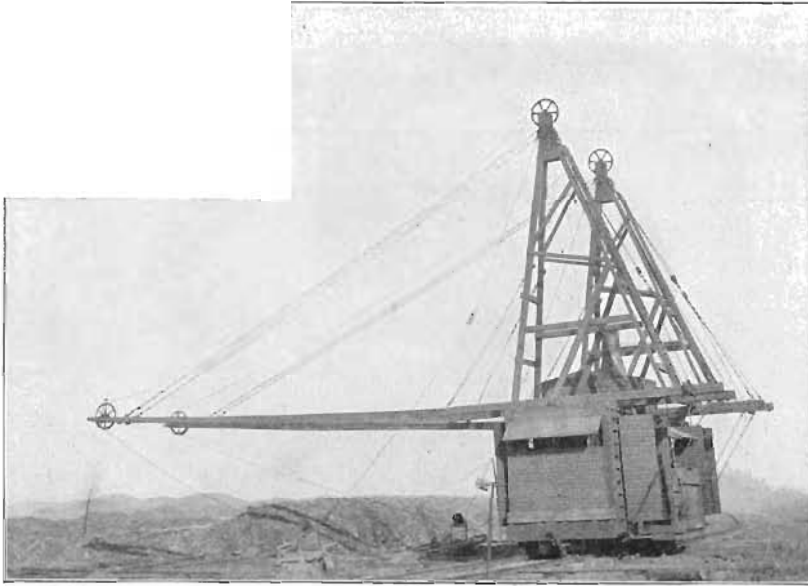

FIG. 76. Burnt clay ballast machine used by the Davy Burnt Clay Ballast Company.

very largely to economical production. The clays best adapted to the manufacture of burnt clay commonly contain high percentages of fluxes. The upland gumbos in particular, which yield the best results, are, on account of their impervious nature, almost wholly unoxidized and unleached. The high percentages of fluxes and the extremely fine textures of the gumbo lower the fusibility and obviously reduce the cost of burning.

The upland type of gumbo has a wide distribution over the southern half of Iowa. It is commonly present on the divides between nearly all of the more important drainage lines and

varies in thickness from a thin veneer or total absence to twenty or even thirty feet. The superficial portion is charged generally with humus and stained a gray-black in color when wet, to lighter shades when dry, and grades downward into an ash-gray to blue-gray, pebbleless and almost gritless deposit. The monotony of the lower portions is broken occasionally by almost white blotches of lime.

The methods used by the Davy company in the manufacture of burnt clay are very simple and very effective. Some five or six

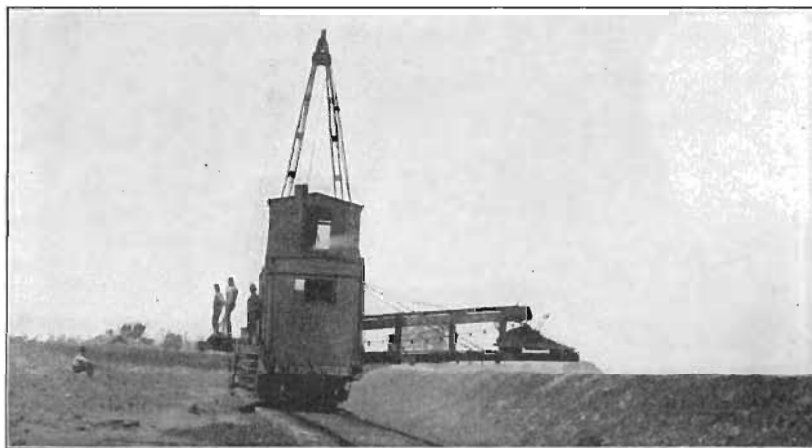

FIG. 77. Coaling machine used by the Davy Burnt Clay Ballast Company.

feet of the surface materials are used. A car mounted on trucks and equipped with a pair of steam shovels working from two extra long booms extending out at right angles to the car constitute the excavating or ballast machine. In opening a pit a windrow of combustible material, usually old ties, bridge material and other refuse, is placed at the margin of the area which it is proposed to exploit. A track is laid in front upon which the ballast machine operates. The steam shovel cuts a trench as it moves ahead, depositing the removed materials on the row of wood on the opposite side of the trench by the scoop running out on the

boom and dumping. The excavating car is followed by a coaling car which consists of a traveling scoop or dredge much on the same principle as the steam shovel which brings the coal to a belt conveyor, which in turn deposits a thin layer of coal evenly over the fresh clay ridge. The track is set back from the trench and the steam shovel cuts a new swath transferring the material across the trench and depositing it evenly over the preceding layer. This in turn is followed by the coaling machine and the process is repeated over and over again. The first layers are fired and the fire passes from one layer to another, the process being continuous when once well under way. The amount of coal added is intended to be sufficient to burn all or nearly all of the clay, but not to fuse it. The value of the ballast depends very largely upon the perfection of the burning. If underburnt the clay slakes and becomes slippery when wet. If completely fused it adds to the expense of distribution. The product of a successful burn consists of fragments more or less uniformly sized, and may be considered an artificial gravel. The usual way of handling the ballast when sufficiently cooled is to lay a track on the opposite side of the pit from the ballast machine and coaler and use a steam shovel. Flat cars are loaded in this way or may be loaded by hand. Thus when the plant is in full blast loading and removal follow closely trenching and coaling. Steam coal, slack and mine waste only are used for burning after the initial kindling. For economical working the pit usually ranges from one-half mile to a mile in length. The methods used in the distribution of the ballast along the right-of-way are the same as those practiced in the distribution of gravel and crushed stone. In addition to the use of burnt clay for railway ballast, it bids fair to serve as a substitute for cinders and gravel in filter beds, and for gravel and crushed stone in concrete and highway work. When the "good roads" movement assumes a more practical form the wealth of raw materials suitable for the manufacture of burnt clay may receive the attention their importance merits.

The Iowan Loess.—The most important loess deposit is known as the Iowan loess. It closely fringes and is supposed to be closely contemporaneous with the drift sheet of that name. The Iowan loess forms a veneer over the older silt and clay deposits mentioned and has the greatest superficial extent of any deposit in the state.

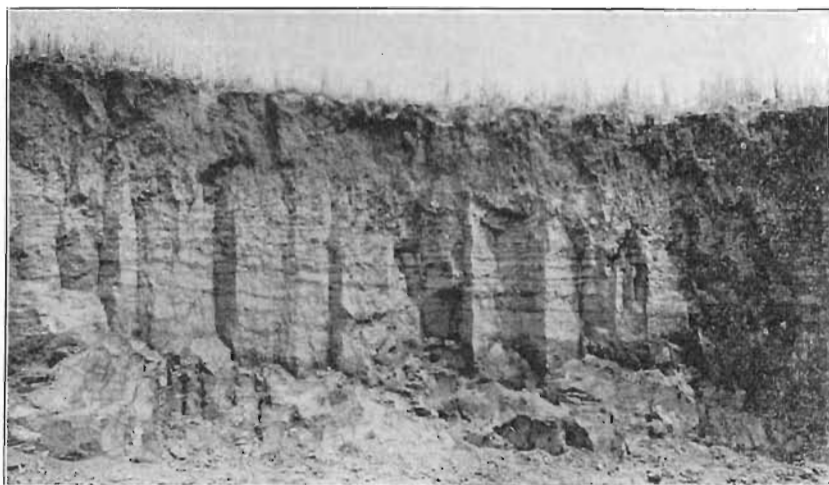

FIG. 78. Stratified loess, in clay pit of Sieg and Size, west of Marshalltown.

The Iowan loess forms an uninterrupted deposit from Lyon and Osceola in the northwest around the Wisconsin lobe to Jasper and Marshall counties, closely fringing the front of the Iowan drift to Johnson and Cedar counties. The Iowan loess also margins the Iowan lobe on the east. While its continuity is unbroken, the Iowan loess presents quite different phases for the different portions of the state. The Missouri river type carries more fine sand and silt than is characteristic of the inland and the Mississippi types. The first type has been developed most extensively at Council Bluffs and Sioux City. The Besley pit at the former place exposes some fifty feet of loess usable in the clay industries. The bulk of the deposit is made up of particles varying from one-sixteenth to one-thirty-second of a millimeter

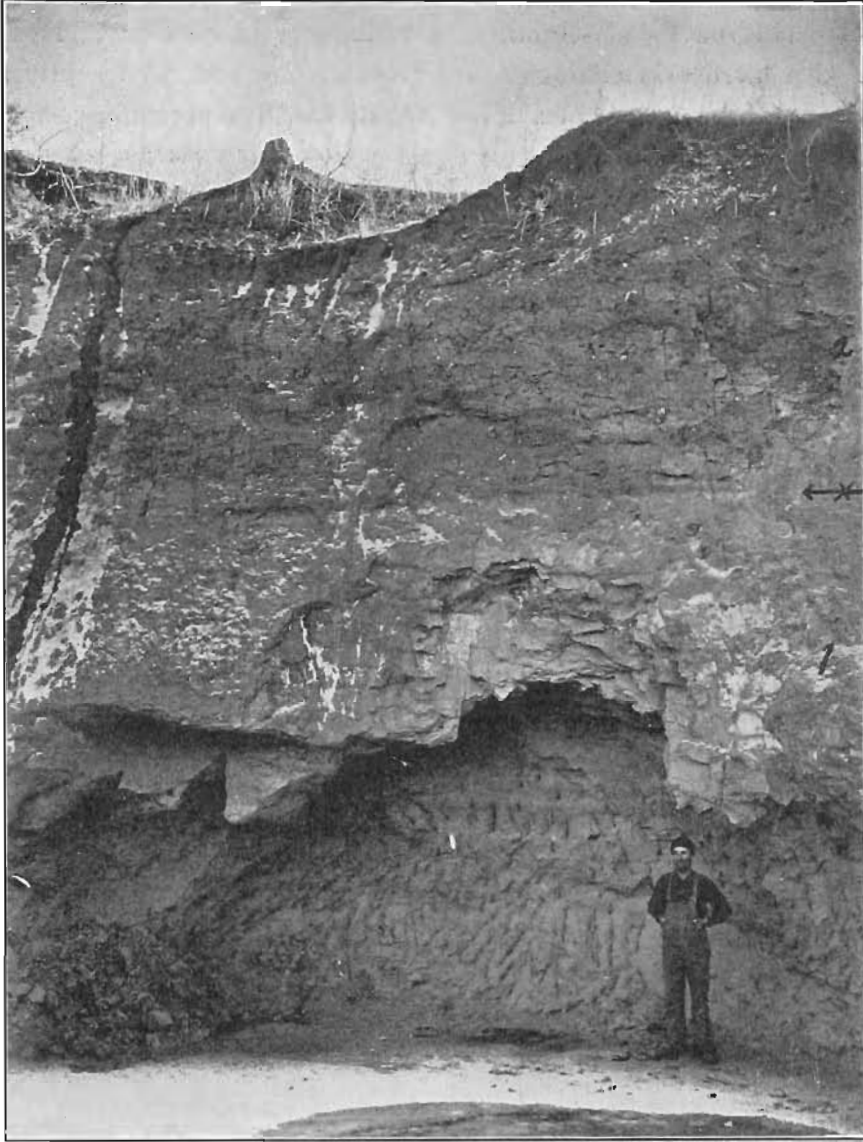

PLATE XXXVII. Clay pit of the Kelly Brick and Tile works. 1, represents the loess, and 2, the Wisconsin drift.

in diameter, less than two per cent consisting of fragments exceeding one-eighth of a millimeter in diameter or smaller than one-hundred twenty-eighth of a millimeter in diameter. It is highly porous in character and breaks along vertical fractures, rarely showing any traces of bedding planes. The prevailing color is a grayish-yellow to a pale straw yellow. It does not possess sufficient plasticity to work well in the manufacture of hollow ware. It yields a fair grade of brick manufactured by soft mud, stiff mud or dress press process. Considerable difficulty is experienced in drying the ware to prevent air checking. Considerable lime is present in the widely disseminated state and as gastropod shells but few concretions are present. Local exceptions are numerous where lime occurs in sufficient amount to render the deposit useless. Three samples were selected from the Besley pit, believed to be representative of the top, middle and lower portions. Complete chemical and rational analyses are given below:

| | TOP. | MIDDLE. | BOTTOM. |
|----------------------|-------|---------|---------|
| Silica..... | 67.15 | 68.22 | 71.76 |
| Alumina..... | 6.55 | 10.21 | 10.12 |
| Combined water..... | 2.03 | 1.52 | 2.94 |
| Clay and sand..... | 75.73 | 79.95 | 84.82 |
| Iron oxide..... | 3.83 | 2.87 | 2.40 |
| Lime..... | 7.36 | 3.90 | 2.52 |
| Magnesia..... | 3.15 | 3.16 | 3.29 |
| Potash..... | .55 | .58 | .47 |
| Soda..... | 1.89 | 1.68 | 1.59 |
| Total fluxes..... | 16.78 | 12.19 | 10.27 |
| Moisture..... | 1.05 | .62 | 1.52 |
| Sulfur trioxide..... | 0.90 | 1.45 | 1.76 |
| Carbon dioxide..... | 5.53 | 5.86 | 1.86 |

RATIONAL ANALYSES.

| | | | |
|--------------------------|--------|--------|--------|
| Clay substance..... | 26.51 | 19.72 | 27.37 |
| Feldspar..... | 28.34 | 25.74 | 19.32 |
| Quartz..... | 32.77 | 40.29 | 46.09 |
| Magnesium carbonate..... | 6.15 | 6.63 | |
| Calcium carbonate..... | 4.70 | 5.16 | 4.25 |
| Calcium sulfate..... | 1.53 | 2.46 | 2.97 |
| | 100.00 | 100.00 | 100.00 |

It will be noted that all are highly siliceous, ranging from 67.15 to 71.76. It is also apparent that they run low in alumina and comparatively high in lime and magnesia. Sufficient iron is present to give a fair color and the high percentage of fluxes causes the ware to melt at a reasonable temperature, notwithstanding the high silica contained and the comparatively coarse material.

Council Bluffs is the largest user of surface clays in the manufacture of brick. The Sioux City material is essentially the same although analyses have not been made. Practically every county in the state where the Iowan loess occurs contains one or more clay plants using it, which have developed it. At Council Bluffs most of the ware is made by the soft mud process although a limited number are turned out as stiff mud brick. In Guthrie county the usual inland type of the Iowan loess prevails over the southern and eastern portion of the county; northeasterly it passes under the Wisconsin drift. It has been worked at a number of points. At Guthrie Center the pit opened by Mr. W. E. Berry may be taken as fairly representative for the district. It is adapted to all of the common processes of brick making and would undoubtedly yield a good face brick. An analysis is given below.

| | |
|----------------------|-------|
| Silica | 68.62 |
| Alumina | 14.98 |
| Combined water..... | 3.55 |
| Clay and sand | 87.15 |
| Iron oxide | 4.16 |
| Lime..... | 1.48 |
| Magnesia..... | 1.09 |
| Manganese oxide..... | .64 |
| Potash | 1.50 |
| Soda..... | 1.86 |
| Total fluxes..... | 10.73 |
| Moisture..... | 2.78 |

It is obvious from a casual inspection of the above analysis that the Guthrie county type is less siliceous, contains a lower

percentage of lime and magnesia and is considerably higher in alumina and iron. It burns a pale color and is much more plastic than the Missouri river type and gives good results in the manufacture of hollow ware. In this region the loess varies from total absence, where it has been removed along stream ways, to fifteen or twenty feet thick near the hill fronts and becomes gradually thinner as the divides are approached.

In Adair county the loess is even more siliceous than the Council Bluffs type. The loess covers the entire county save where it

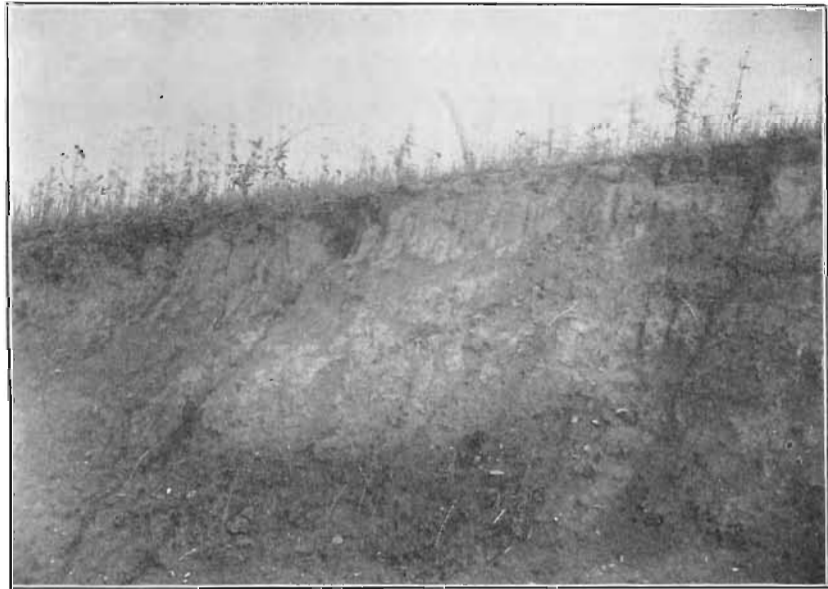

FIG. 79. Loess occurring over stratified drift in the pit of the Le Mars Brick and Tile Company, Plymouth county, Iowa.

has been removed by the streams. It varies from a few feet to thirty feet in thickness and is used at a number of points in the manufacture of clay wares. It is usually quite homogeneous and free from impurities. Occasionally it carries small calcareous concretions and a few gastropod remains. At Bridgewater the Gillette brickyard, located just south of the pit, is developing the loess. Under the soil, which is usually removed, lies a gray joint

clay which is used in the manufacture of common brick. An analysis of the clay shows the following constituents:

| | |
|---------------------|-------|
| Silica..... | 77.13 |
| Alumina..... | 10.75 |
| Combined water..... | 2.22 |
| Clay and sand..... | 90.10 |
| Iron oxide..... | 2.38 |
| Lime..... | 2.08 |
| Magnesia..... | 0.83 |
| Potash..... | 1.73 |
| Soda..... | 0.60 |
| | 7.62 |
| Moisture..... | 1.45 |

Although the amount of iron runs lower than for most of the inland loess, yet sufficient is present to give a good color to the burnt ware. The clay is also suitable for making drain tile.

The Iowan loess has also been extensively developed in and around Des Moines, in Polk county. In many cases the loess has been somewhat modified by drift wash and alluvium. It has been manufactured by all of the well known processes of brick making. Modified loess has been used quite extensively by the Dale Brick Company. An analysis of the average material taken from the pit is as follows:

| | |
|---------------------|-------|
| Silica..... | 73.69 |
| Alumina..... | 9.68 |
| Combined water..... | 3.88 |
| Clay and sand..... | 87.25 |
| Iron oxide..... | 5.36 |
| Lime..... | 1.53 |
| Magnesia..... | 1.01 |
| Potash..... | 1.27 |
| Soda..... | 2.72 |
| Total fluxes..... | 11.89 |
| Moisture..... | .71 |

RATIONAL ANALYSIS.

| | |
|---------------------|--------|
| Clay substance..... | 31.30 |
| Feldspar..... | 12.47 |
| Quartz..... | 56.23 |
| | 100.00 |

It may be noted that the Dale clay runs exceptionally high in silica and quartz sand and is comparatively low in alumina and magnesia. It also runs high in the stronger fluxes, soda and potash, and notwithstanding its high siliceous percentage burns at a reasonable temperature. It also runs high in iron and assumes a deep cherry red when burnt. The ware gives good satisfaction as face brick and is used extensively as a trimming for interior finish and has been adopted as a veneer for many railway buildings along the Rock Island and the Northwestern railways.

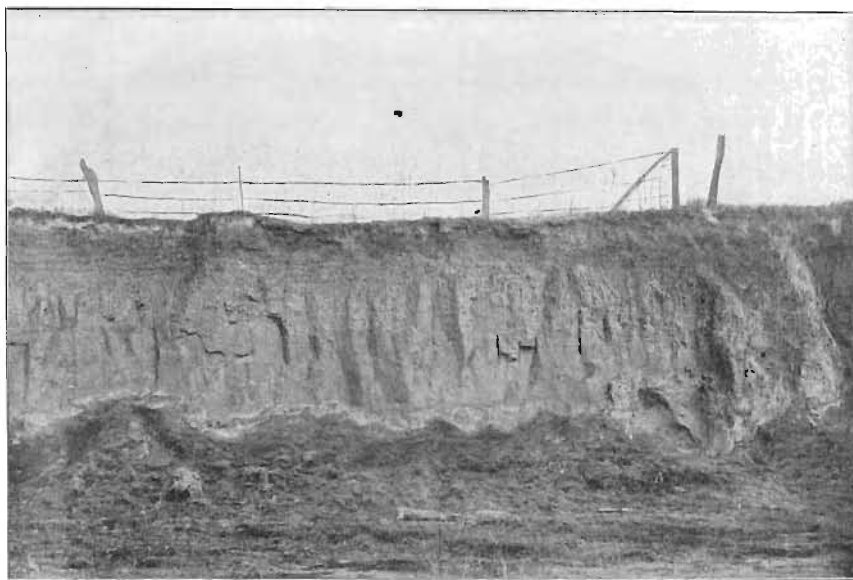

FIG. 80. Pit of C. B. Bentley & Son, one mile east of Tama, Iowa.

In the manufacture of dry press brick the Iowan loess has been most extensively developed near the Iowan drift margin at Gladbrook, in Tama county. Two large factories have been using it at this point for a number of years. The loess area varies from ten to twenty feet in thickness and while all the inland type carries a higher percentage of the coarser materials than the loess in the southern tier of counties, it contains a sufficient amount of

flux to insure burning at moderately low temperatures, and is high enough in iron to yield a good color. An analysis of the loess selected from the pit of the Gethmann Brothers is as follows:

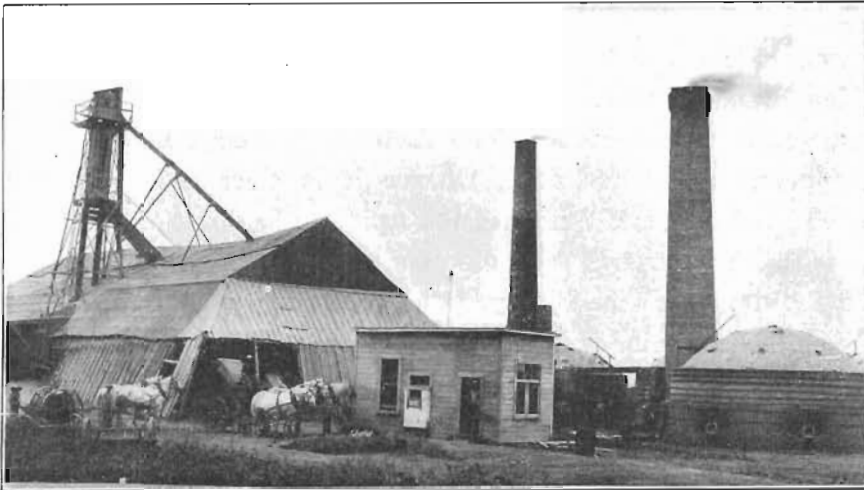

FIG. 81. Plant of Gethmann Brothers Pressed Brick Company, Gladbrook, Iowa.

| | |
|---------------------|-------|
| Silica | 67.92 |
| Alumina | 11.76 |
| Combined water..... | 5.36 |
| | <hr/> |
| Clay and sand | 85.04 |
| Iron oxide..... | 6.72 |
| Lime | 1.63 |
| Magnesia | 1.18 |
| Potash..... | 1.87 |
| Soda | 1.92 |
| | <hr/> |
| Total fluxes..... | 13.32 |
| Moisture | 1.49 |

RATIONAL ANALYSIS.

| | |
|----------------------|-------|
| Clay substance | 39.90 |
| Feldspar..... | 19.80 |
| Quartz | 40.28 |
| | <hr/> |
| | 99.98 |

Certain portions of the loess contain a higher percentage of the finer constituents and are sufficiently plastic to be used in the manufacture of drain tile. As in practically all of the loess, considerable care must be used in drying to prevent undue loss by air checking. Both of the Gladbrook factories gather the clay and dry it in the same way. The pit covers quite an extensive area, is plowed and permitted to weather a few days; is then collected by automatic loaders, hauled to the factory by teams, dumped into a hopper-shaped chute, from whence it is elevated into storage sheds and kept until most of the moisture has been evaporated. It is then put through rolls, elevated and screened, and conducted to the dry press machinery. The product is uniform in character, of good color and gives good service as face brick and structural brick.

The loess in Warren county is of the inland type and is being used at a number of points for common building brick and drain tile. Two samples selected from the pit of the Indianola Brick and Tile Company were analyzed by Professor G. E. Patrick. The first sample was taken near the surface, just below the soil, while the second is dark gray in color and is found below the upper yellow loess. The results of the analyses are given below:

| | No. 1. | No. 2. |
|-----------------------|--------|--------|
| Silica | 72.24 | 63.31 |
| Alumina | 12.58 | 16.51 |
| Combined water | 3.33 | 6.89 |
| | <hr/> | <hr/> |
| Clay and sand | 88.15 | 86.71 |
| Iron oxide | 4.02 | 4.06 |
| Lime | 1.40 | 1.11 |
| Magnesia | .99 | 1.10 |
| Manganese oxide | | 0.49 |
| Potash..... | 1.54 | .96 |
| Soda..... | 2.60 | 2.20 |
| | <hr/> | <hr/> |
| Total fluxes | 10.55 | 9.92 |
| Moisture..... | 1.70 | 3.76 |

It will be noted that the upper loess is more highly siliceous and is poorer in aluminum than the lower. The lower clay is slightly poorer in the fluxing constituents but slightly more plastic. The chief output of the plant is common building brick.

THE WISCONSIN.

The Wisconsin drift forms a tongue-shaped lobe whose apex extends well down past the middle of the state, Capitol Hill, in Des Moines, marking its southern extension. The lobe loops to the westward to the middle branch of the Raccoon river, in Dallas and Guthrie counties, continues diagonally across Carroll, through Sac, Buena Vista, Cherokee and O'Brien counties, looping back to the middle of O'Brien and Osceola county line and then northwesterly across the corner of Lyon county to the Minnesota line. The eastern limits have already been given as the Altamont moraine. The Wisconsin is characterized by large numbers of bowlders of various sizes, many of which are calcareous in character. The drift carries a large quantity of gravel, lime concretions and lime in the widely disseminated form. In the vicinity of some of the old lake beds and some of the draws and ravines, the wash from the drift has accumulated to depths of several feet and is fairly free from the bowlder and lime impurities, and is easily wrought into the cheaper grades of clay wares. The Wisconsin has been developed with varying degrees of success at a number of points. While it is no better adapted for the manufacture of clay products than materials derived from the other drift sheets, the demand for clay goods has been greater because of the scarcity of shales in the district and because of the great demand for drain tile, owing to the undrained character of the surface. A casual inspection of the map will show the great scarcity of drainage lines. The larger systems only being outlined, and the map shows a remarkable scarcity of the smaller tributaries. The Wisconsin area is the region of the Iowa lakes,

and a line so drawn as to take in all of the lakes and ponds of mapable size will approximately coincide with the limits of the Wisconsin drift. Because of the great demands and the relative scarcity of suitable material for the manufacture of clay goods, more persistent efforts have been made to utilize the Wisconsin than have been made toward the utilization of any other drift sheet.

Buena Vista County.—Russell Brothers of Storm Lake are developing modified Wisconsin drift. Their plant is located about one-half mile east of the Illinois Central railway depot, north of the railway track. The clay is obtained in the immediate vicinity and consists of a surface wash of silt and clay, free from gravel, and limestone concretions are not common. Below the black loam the yellow clay bears a blotchy appearance due to the presence of partially weathered pyrites. The clay averages five to six feet in thickness and resembles a gumbo. It is very similar to the material used in the manufacture of brick and tile at Dysart, in Tama county. A chemical analysis was made and the results are given below:

| | |
|---------------------|-------|
| Silica | 66.44 |
| Alumina..... | 12.64 |
| Combined water..... | 5.83 |
| | — |
| Clay and sand | 84.91 |
| Iron oxide..... | 4.00 |
| Lime..... | 4.02 |
| Magnesia..... | 1.80 |
| Potash..... | 1.14 |
| Soda..... | 1.90 |
| | — |
| Total fluxes | 12.86 |
| Moisture..... | 2.33 |

RATIONAL ANALYSIS.

| | |
|---------------------|--------|
| Clay substance..... | 38.80 |
| Feldspar..... | 24.84 |
| Quartz..... | 36.36 |
| | — |
| | 100.00 |

It will be noted by a casual inspection of the analysis that the clay is relatively high in silica and lime and low in alumina. In this respect it closely resembles the loess. It is also high in feldspar, another character common to the loess. Drain tile is the principal product, although a few common building brick are manufactured.

Clay County.—The Spencer Brick and Tile Works is located about a mile and one-half north of the station of the Chicago, Milwaukee & St. Paul railroad, between the Little Sioux river and the Spirit Lake Branch of the railroad. Formerly brick were made by hand, but at the present time a stiff mud machine is used. Great care is required to prevent checking in drying. The pit section is as follows:

| | FEET. |
|---|-------|
| 4. Soil, black grading into brown and calcareous below..... | 3½ |
| 3. Clay, gray to yellow, clouded..... | 2¾ |
| 2. Clay, grayish, plastic, jointed..... | 1½ |
| 1. Clay, drab, sandy in lower part..... | 19 |

With the exception of a thin layer of soil, the entire section is utilized. Considerable care is exercised in the removal of lime concretions which are present in small quantity throughout the section. Number 2 is decidedly loess-like and the entire series resembles altered upland material. The loess-like member was analyzed and the results are as follows:

| | |
|---------------------|-------|
| Silica..... | 52.42 |
| Alumina..... | 13.04 |
| Combined water..... | 4.06 |
| Clay and sand..... | 68.52 |
| Iron oxide..... | 6.24 |
| Lime..... | 7.98 |
| Magnesia..... | 2.24 |
| Potash..... | 1.41 |
| Soda..... | 2.67 |
| Total fluxes..... | 20.54 |
| Moisture..... | 2.67 |
| Carbon dioxide..... | 7.51 |

The analysis does not show any marked loess-like affinities save in the low percentage of alumina. It is much lower in silica and carries more of the carbonates than is usual in the loess. During wet seasons some difficulty is experienced in keeping the pit dry enough to work the entire section.

Pocahontas County.—The Wisconsin drift has been most extensively used at Fonda at Straight Brothers. The raw clay is obtained from a pit immediately west of the factory, which is located opposite the Illinois Central depot. The pit shows typical Wisconsin drift with its characteristic gravels, bowlders, lime concretions and all. The clay has been worked to a depth of over twenty feet, pumping being necessary to keep the pit dry during certain seasons of the year. The soil and partially oxidized yellow bowlder clay comprise about two-thirds of the section, the gray blue to blue clay making up the lower one-third. The material is plowed, allowed to weather and dry out more or less; is then loaded into cars by means of horse scrapers, after which it is drawn to the factory by a tail rope. The clay is carried by means of a belt conveyor to the clay working machinery, which consists of a nine-foot Eagle dry pan in which the mullers are suspended so as not to pulverize the gravel and lime concretions too fine. The gravel is removed by a shovel and thrown into an elevator which conveys it to a slumming box fitted with an auger pugger and screens. The finer clay and silt particles rise and float off into a chute, are elevated and sent back to the pug mill. The part which passes through the dry pan is elevated and passes from a fine mesh inclined screen. Screenings are led directly to the combined brick and tile machine. Tailings pass into the slumming box as is the case with the tailings from the dry pan. Both brick and drain tile up to eight inches in diameter are manufactured, the ware giving good satisfaction. It burns a pale red, quite similar in color to the product from the Devonian shales at Mason City. It is strong and little loss is sustained through air and fire checking.

Numerous attempts have been made to develop the Wisconsin at other points but usually without taking the precautions of removing the gravel and lime concretions. The results have been variable, never wholly satisfactory and numerous failures have been recorded.

Clay works using modified Wisconsin drift have been in continuous operation at Jewell Junction, Hamilton county; Manson and Lohrville, in Calhoun county; Sioux Rapids, Buena Vista, Eagle Grove, in Wright county; Livermore, in Humboldt county; and Spencer, in Clay county. The methods used are very similar to those at Storm Lake. Unaltered Wisconsin drift can not be used with a reasonable chance of success unless the same precautions are observed as those at Fonda in its use. Numerous areas can be found, doubtless, of Wisconsin drift where the pebbles, boulders and lime concretions have been largely removed, as is the case at Storm Lake and Jewell Junction, and in such cases the clays will respond satisfactorily to the treatment ordinarily accorded surface clays. Considerable loss may be expected during the process of drying and some loss perhaps during burning, but the great demand with the consequent high prices ought to stimulate the growth of the industry in the counties covered by the Wisconsin drift. Large plants have been established recently at Estherville, in Emmet county, and at Britt, in Hancock county. Others will be organized in the near future. In addition to the deposits which have accumulated in the depressions of the lake bed type, as at Storm Lake, less important deposits may be found along small ravines and draws, along the larger drainage lines, as alluvium and the so-called "white oak" soil which face some of the more important streamways. The first will be described here, while the latter will be described under the head of Post-Wisconsin deposits.

It is a well known fact that the finer particles from hilltops and slopes slowly gravitate toward lower levels. This change of

position may be initiated and doubtless is accentuated in times of freshets, but even gentle rains facilitate the downward movement until eventually these finer materials find lodgment on the lower hillslopes and ravines, where they are in more or less stable position. This is a natural slumming process, the coarser materials being left behind. They often show some evidence of sorting and stratification, proving that running water has had something to do with their deposition, while in other places no structural features are apparent. They are always of heterogeneous character both chemically and mineralogically, showing their descent from several different kinds of rocks and also evidencing their temporal character. Such clays yield readily by the soft mud process and have been used stiff mud at Eagle Grove and Iowa Falls, both for brick and drain tile.

POST-WISCONSIN.

Deposits of clays and silts, younger than the Wisconsin drift, are found along the larger streamways and on many of the bluffs facing the larger streams. The former are known as alluvial deposits, while the latter are believed to have been accumulated through the agency of the wind. Both are very heterogeneous in character both mineralogically and chemically and are composed of fine sand, silt and clay, the first two oftentimes comprising more than half of the entire bulk. Alluvium is found along all those streams which have built flood plains for themselves and varies in thickness from a few inches to a number of feet. It is easily obtained and yields readily to the simplest processes of the clay worker. In Iowa the alluvium affords the raw materials for the manufacture of soft mud brick only. On account of the high percentage of fine sand, it is usually short, dries easily and shrinks but little where the clay and silts greatly predominate. The alluvial deposits can not be used alone, because of the high shrinkage during drying and the attendant loss through check-

ing. The short alluvial clays when blended with more plastic materials may be used by the stiff mud process in the manufacture of common brick and hollow ware. The older alluvial deposits are usually found on terraces or benches above the present stream flood plain and are often known as the second bottom deposits. They are very similar in character to the modern alluvial deposits and are treated in the same way in the manufacture of clay goods.

The wind deposits flank most of the larger streams of the state, usually on the opposite side from which the prevailing winds blow. They are commonly quite highly arenaceous to silty, gray-brown deposits and are devoid of pebbles and boulders. They are of mixed chemical and mineralogical compositions but are highly siliceous. The deposits obtain a thickness from five to ten feet, often not exceeding one to three feet. They attain their maximum thickness on the brow of the bluffs and thin quite rapidly inland, rarely being recognizable more than a mile from the bluffs' scarp. They are often known locally as white oak soils because that very well known and desirable species of oak finds in them a congenial host. The deposits are thoroughly oxidized and leached and structural or bedding planes are absent. The coarsest materials which enter into their composition are found nearest the flood plain and the size of grain diminishes gradually as the deposit feathers out away from the river. The source of materials and the transporting agent are not difficult to apprehend. The process of accumulation is going on today. Winds sweeping across the broad flood plain gather up such material as can be transported and move it towards the restraining bluffs. Only the very finest materials are given continuous passage for any considerable distance, but through successive short excursions the coarsest silt particles and fine sand grains eventually reach the brow of the bluffs and are deposited in the reverse order of their fineness. The position of these deposits is determined essentially

by surface contours. When crossing the valley the wind impinges against the hill flanks, is deflected upward and coming in contact with the still air above, loses velocity and being unable to carry its load further, deposits it over the brow of the hill. In this location its position is reasonably secure, although the entire assemblage of deposits possesses proclivities of the sand dune and may progress bodily inland. This process of wind transport and accumulation of materials may readily be witnessed during early spring and late autumn, when large tracts of bottom land are unprotected by vegetation. Dust storms are common and often during a single storm a measurable deposit is accumulated. If this be true now, how much greater must have been the efficiency of the winds which blew across the wide flood plains before vegetation had time to reclaim the valleys so recently vacated by the various ice sheets. The prevailing winds in Iowa during spring and fall are from the west, and hence the greater accumulation of aeolean deposits are on the eastern flank of the streams. Structurally, texturally and in composition and distribution, there is a remarkable resemblance between these wind accumulated deposits and the loess. Both are essentially devoid of stratification planes, possess similar compositions and textures and are highly siliceous, and bear the same relationships to the chief water courses along which they attain their maximum development. The wind deposits have been used at a number of points for the manufacture of common soft mud brick. These deposits with alluvium may be counted on as a source of raw materials suitable for the manufacture of clay wares in the Wisconsin drift area. The supply, however, is somewhat limited and in this territory the deposits rarely exceed more than two or three feet in thickness. Outside of the Wisconsin the deposits attain much greater thicknesses and have been accumulating, doubtless, for a much longer time than since the retreat of the Wisconsin ice.

TESTS OF CLAY PRODUCTS

BY

A. MARSTON.

TESTS OF CLAY PRODUCTS

BY A. MARSTON.

CONTENTS.

| | Page |
|--|------|
| Chapter VIII. | |
| Tests of dry press building brick commonly used in Iowa..... | 558 |
| Introduction..... | 558 |
| Key to kinds of brick..... | 559 |
| Compression tests..... | 562 |
| Transverse tests..... | 563 |
| Absorption tests..... | 564 |
| Freezing and thawing tests..... | 565 |
| Comparison of tests..... | 571 |
| Summary of tests..... | 573 |
| Tests of Iowa common brick..... | 574 |
| Introduction..... | 574 |
| Manner of testing..... | 575 |
| Brick tested..... | 576 |
| Besley brick..... | 577 |
| Webster City brick..... | 577 |
| Dale brick (Des Moines)..... | 578 |
| Grand Junction brick..... | 578 |
| Mason City brick..... | 578 |
| Ames and Kelly brick..... | 579 |
| Structure of brick tested..... | 580 |
| Results of transverse tests..... | 587 |
| Results of absorption tests..... | 589 |
| Results of freezing tests..... | 590 |
| Comparison of tests..... | 592 |
| Table showing comparative results of brick tests..... | 595 |
| Rating formula..... | 595 |

| | Page |
|--|------|
| Tests of strength of hollow building blocks | 593 |
| Advantages of hollow blocks | 599 |
| Tests of hollow blocks | 600 |
| Tests of Iowa paving brick | 601 |
| General considerations | 601 |
| Advantages of brick paving | 602 |
| Paving brick tests..... | 603 |
| The crushing test | 606 |
| The absorption test..... | 608 |
| The transverse test | 609 |
| The rattler test | 613 |
| Specifications for standard method of conducting rattler tests | 617 |
| Table showing numerical values of rattler tests..... | 620 |

CHAPTER VIII.

Tests of Dry Press Building Brick Commonly Used in Iowa.

INTRODUCTION.

The series of tests described in this paper was undertaken with two aims in view. First, to determine the relative qualities of the dry press building brick commonly in use in this state, especially with a view to determine whether or not the home made brick were equal to those imported from adjoining states; second, to determine in the course of the tests various points of scientific interest in connection with the proper methods of testing dry press building brick.

As regards the first of the above objects it may be said that in the diagrams accompanying this paper the relative rank of the different kinds of brick may be readily seen. On these diagrams the different kinds of brick are indicated by letters for the sake of simplicity. The key to the kinds is given in the following table:

KEY TO KINDS OF BRICK.

| Letter. | KIND. | Letter | KIND. |
|---------|-----------------------------|--------|----------------------------|
| A | Van Meter Red. | a | Van Meter "d" Red. |
| B | Van Meter Buff. | b | La Salle No. 2 Buff. |
| C | La Salle Buff. | c | La Salle No. 1. Mottled. |
| D | Corey "a" Red. | d | St. Louis 7 Red. |
| E | Omaha 10 Red. | e | Corey 20 red. |
| F | Dale Goodwin Buff "P". | f | Corey "F" Buff. |
| G | St. Louis 100 Red Granite. | g | Corey 16 Red. |
| H | St. Louis 500 Mottled Gray. | h | St. Louis 500 Steel Gray. |
| I | La Salle 1 Red. | i | La Salle No. 2 Mottled. |
| J | Corey 7 and 9 Buff. | j | St. Louis 509 Red Granite. |
| K | Omaha 555 Buff. | k | Omaha 575 Gray. |
| L | Dale Goodwin Buff "B". | l | Omaha 550 Light Mottled. |
| M | Gethmann No. 10 Red. | m | St. Louis 511 Light Buff. |
| N | Gladbrook No. 1 Red. | n | Omaha 550 Dark Mottled. |
| O | Gethmann No. 6 Red. | o | Omaha 5 Red. |
| P | Gladbrook No. 3 Red. | p | Gladbrook No. 6 Red. |

The capital letters refer to those kinds in which cubes were frozen and thawed 40 times, while the small letters refer to those frozen and thawed 20 times.

In figure 89 the bricks are ranked in the order of their transverse strength. While the rank would vary with the different tests yet it will be seen that brick A, the Van Meter Red, ranked highest in all of the tests. This speaks well for Iowa brick. Brick B, the Van Meter Buff, ranks next. This brick makes a beautiful material for building purposes. It has been used for the construction of the Chimes Tower of the Iowa State College at Ames, Iowa, and in this structure has stood the test of several years exposure to the elements. The tower remains as beautiful as it was when first erected and stands as a monument to the good quality of Iowa pressed brick.

Bricks D, e and g, Corey Red manufactured at Lehigh, Iowa, and bricks J and f, the Corey Buff manufactured at the same place, are also most excellent brick manufactured in Iowa. Together with the Van Meter Buff the Corey Buff brick have been used for the interior finish of the walls of the new Engineering

Hall at Ames, which by many competent persons, has been pronounced the finest building of its kind in the country. The use of buff, dry pressed brick for the interior finish of churches and other public buildings is becoming deservedly popular. It makes a finish which, unlike plaster, is permanent as well as pleasing. If the walls should become stained with dirt they can be cleaned without the necessity of putting on a fresh coat of plaster, kalsomine or paint.

Bricks F and L, Dale Goodwin Buff, manufactured at Grand Junction, and bricks M, N, O, P and p, all red pressed brick manufactured at Gladbrook, Iowa, by the Gladbrook Pressed Brick Company and by Gethmann Brothers, are also excellent dry pressed brick.

This series of tests has thoroughly demonstrated that in quality Iowa dry pressed brick can compete with any manufactured in the country. Where the Iowa plants are lacking at present is, first, in their facilities for making brick in sufficient quantities so that architects and contractors can rely upon their being obtained without undue delay; and second, in their facilities for supplying different architectural grades of brick. Both of these deficiencies are of such nature as to be readily supplied by Iowa manufacturers. The question of quantity is one simply of a plant large enough for carrying on the work. The writer has had unfortunate experiences in getting Iowa dry pressed brick in quantities sufficient to enable the rapid carrying on of work in which he has specified their use. The quality of the brick is such that if well advertised and exploited there should be no trouble in disposing of the products of large plants.

The question of different architectural grades of brick is one for experimentation with different qualities of material and with the substances commonly used to produce the different colors and surfaces needed for architectural appearances. It is now possible to have samples of clay sent to the Ceramic Lab-

oratory at Ames, and there tested to determine what can be attained along these lines. There is no doubt that any enterprising manufacturer of good dry press brick could develop a sufficient number of kinds of brick to meet all necessities.

Incidentally, by the way, the query may be propounded, why do not the manufacturers of dry pressed brick in Iowa turn out to the meetings of the Brick and Tile Association, and display a public interest in the advancement of this industry? In the procuring of the specimens for these tests more trouble was experienced with one of the Iowa manufacturers than with all of the companies outside of the state. It is difficult to understand why this should be so when the tests were carried on without expense to the manufacturers and were planned mainly for their benefit.

It is to the second of the purposes for which these experiments were planned that this discussion will be mainly confined. To indicate what degree of reliability may be given to the conclusions reached, the number of tests may be stated; in all about 800 transverse tests were made; 100 crushing tests; 128 specific gravity determinations; 128 freezing and thawing tests. In all some 32 grades of dry press building brick from eight different companies were thoroughly tested, and several grades were partially tested. In testing each grade of brick twenty or more transverse tests were first made. From the ends of these broken brick cubes were then prepared for the crushing, absorption, specific gravity, and freezing and thawing tests.

The transverse tests were carried out in the manner adopted as standard by the Department of Civil Engineering of the Iowa State College for making such tests. Knife edges six inches apart, rounded both ways, were used to support the brick which were placed on edge in the machine. An adjustable knife edge was used at the top to apply the load mid-way be-

tween the supports. Steel bearing blocks were used between all knife edges and the brick to keep the knife edges from cutting into the brick and causing failure from local injury.

The crushing tests were partially made on two-inch cubes with two smooth surfaces at top and bottom, the bearing surfaces of the testing machine being steel plates. Other tests from the same brick were made upon specimens of larger size, each about one-third of a brick placed flatwise in the machine, and bedded above and below with plaster of Paris. The absorption, specific gravity, and thawing and freezing tests were all made upon four different kinds of cubes for each grade tested. For each grade two-inch and one-inch cubes ground truly to shape and size were tested, and also two-inch and one-inch cubes simply chipped out approximately to shape and size, but with surfaces left rough.

Compression Tests.—In fig. 82, the results of the compression tests are shown, and it will be noted that the tests of two-inch cubes with steel bearing plates showed considerable higher re-

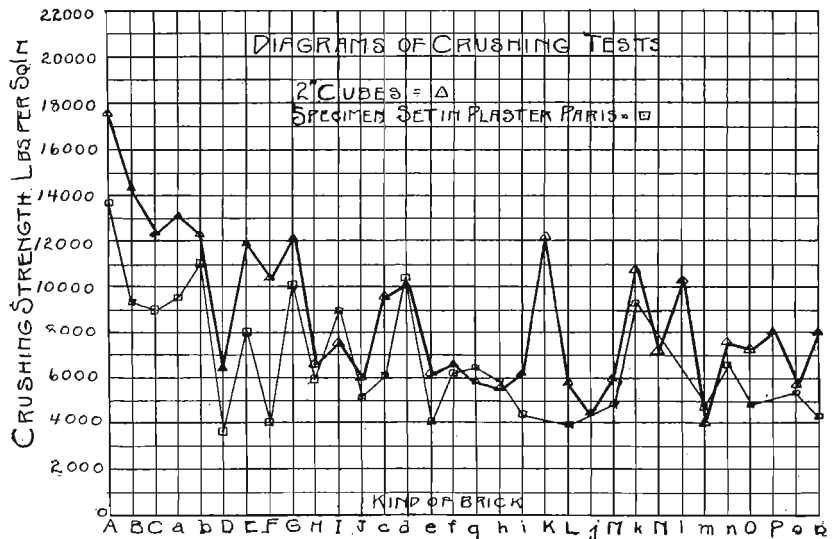

FIG. 82. Diagram showing results of compression tests.

sults than the tests of specimens set in plaster of Paris. For standard tests the writer is of the opinion that the specimens should be ground to two-inch cubes and steel bearing surfaces used.

Transverse Tests.—In fig. 83 four typical transverse tests were platted in detail. The transverse tests for the other grades would show similar results. The point brought out specially in these diagrams is the great lack of uniformity of the different individual specimens of the brick tested. Practical brick-makers are thoroughly aware that in each kiln of brick they make, all qualities of brick are found, from those too soft to use for any purpose, to those which are the best that they can turn out, and still further to those that are so over-burned as to be of no value for building purposes. Engineers and architects, however, in their specifications and in their modes of

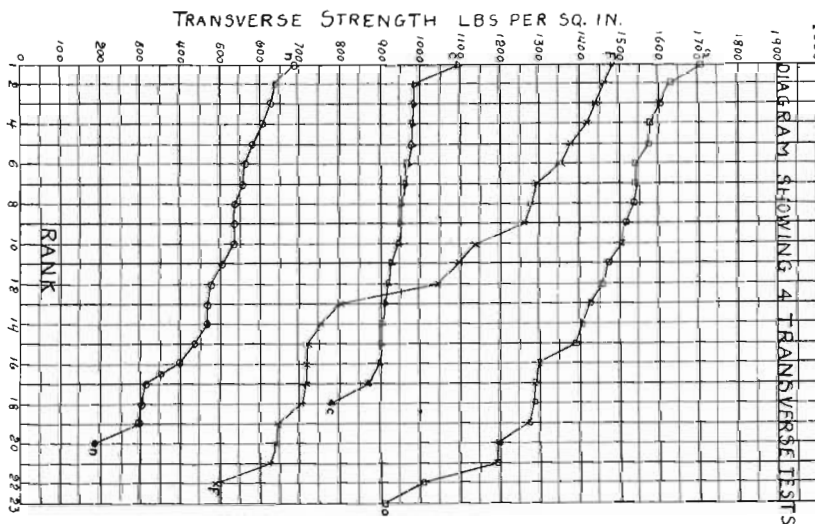

FIG. 83. Diagram showing results of transverse tests.

testing, seem to have overlooked, or not to have understood, this fact. Where the lack of uniformity is so great as is indicated by these transverse tests, it is evidently useless to try to rank

brick by tests of only a few from each grade, yet that is what is commonly attempted. It is often urged against transverse tests that they fail to give uniform results, but as the outcome of having personally seen to the carrying out of thousands of transverse tests the writer wishes emphatically to express his opinion that the transverse tests truly indicate the facts regarding the structure of the brick. They are to be commended, instead of condemned, because they bring out these facts. The writer has carried on such tests by the hundred, making comparison of the structure of each brick with the results of the transverse tests, and he is firmly convinced of the value of the transverse tests as indicating the quality of the brick. One of the most valuable characteristics of transverse tests is the facility with which they are made. On account of this facility a large number can be carried out for each grade of brick tested, and the average will give results correspondingly more reliable than those of a small number of brick.

The other tests also gave widely varying results when made upon different specimens of the same grade of brick. This is to be carefully borne in mind whenever an attempt is made to compare the ranking of different grades of brick by the results of the different tests, and it explains the most of the discrepancies which are usually noted.

Absorption Tests.—In figs. 84 and 85, the final results of the absorption tests for the different grades of brick are shown. In carrying out the absorption tests the specimens were first dried in an oven until they showed no further loss of weight from evaporation, and were then completely immersed in water and weighed at intervals. All the specimens showed a rapid absorption of water within the first three or four hours, and after the first twenty-four hours they showed a small, but still quite appreciable, increase in absorption. The specimens were left immersed about ten days, and at the end of the experiments

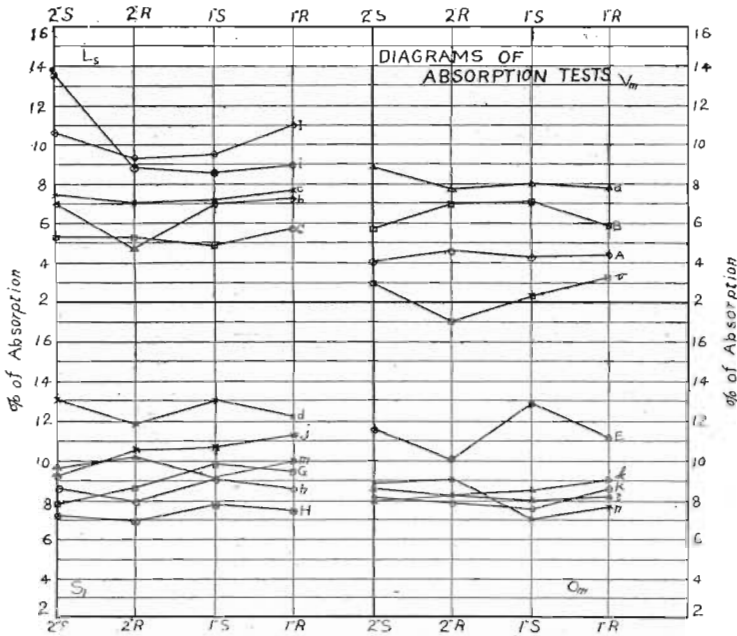

FIG. 84. Diagram showing results of absorption tests.

they were still absorbing water, so that the results given cannot be taken as the final per cents which they would take up. In figs. 84 and 85, the results of the different cubes are indicated by the figures and letters. 2" S indicates the two-inch smooth cube; 2" R indicates the two-inch rough cube, and the one-inch smooth and the one-inch rough cubes are indicated in similar ways. A careful study of the diagrams will show that there is no very great difference in the results with the different specimens. On the whole, however, the smaller cubes give slightly greater per cents than the larger cubes.

Freezing and Thawing Tests.—In figs. 86 and 87, the results of the freezing and thawing tests are indicated in a similar manner. These freezing and thawing tests were made upon the specimens saturated for the absorption tests. These were put into a freezing box, in which a temperature of from zero to six

TESTS OF CLAY PRODUCTS.

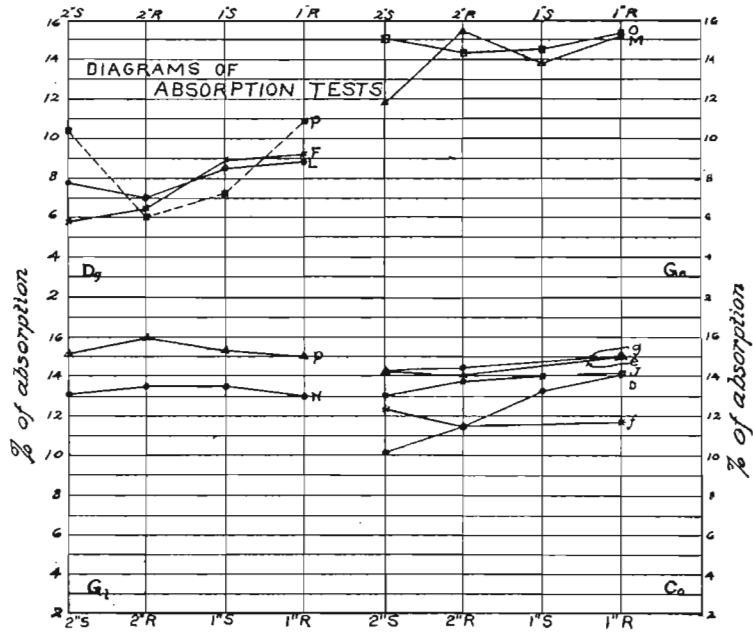

FIG. 85. Diagram showing per cent of absorption of brick tested.

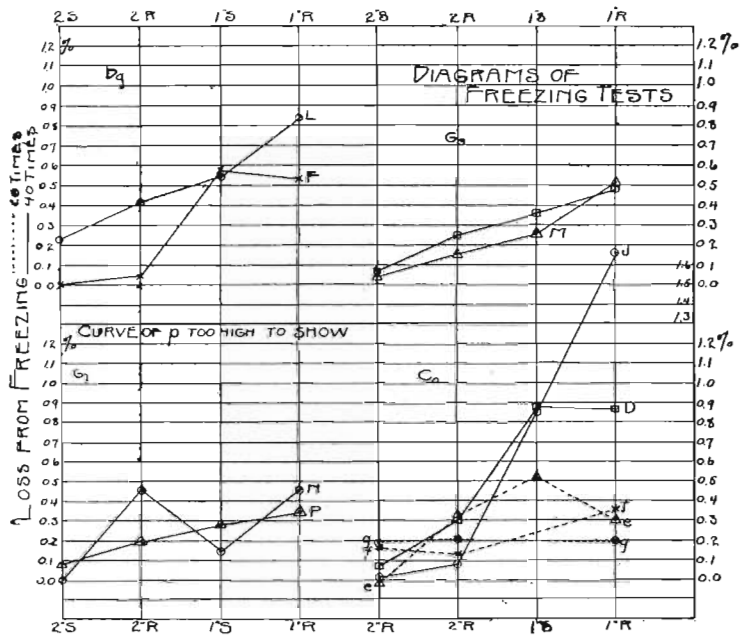

FIG. 86. Diagram showing results of freezing tests.

degrees above zero F. was maintained by a mixture of salt and ice. During the first twenty freezings and thawings the specimens were first frozen forty-eight hours, and then thawed by immersing in water for twenty-four hours. After the first twenty tests, the time of freezing was reduced to twenty-four hours, as the temperature records indicated that the cubes were completely frozen in that time. The writer advocates the twenty-four hour period as standard for such tests. The results of the tests show clearly that the rough cubes give greater losses than the smooth cubes, and that the small cubes give

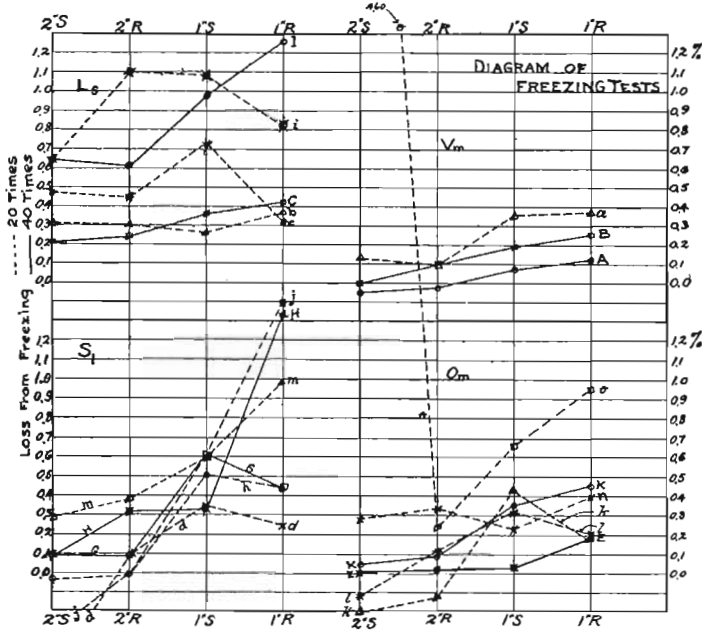
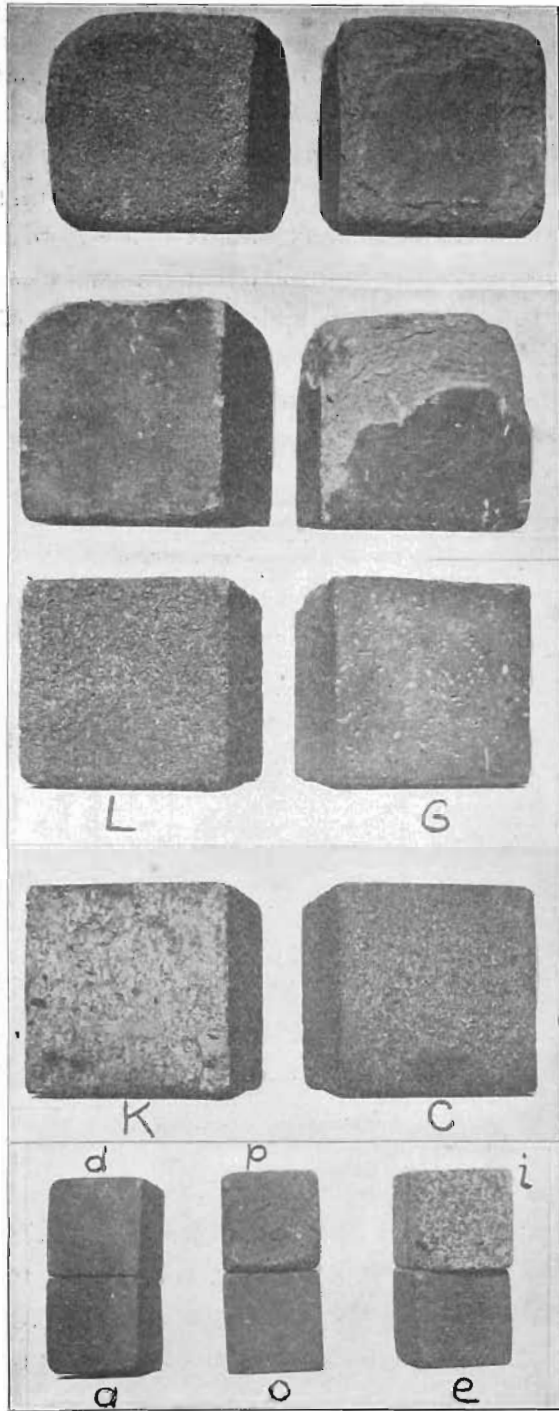

FIG. 87. Diagram showing comparative loss on a varying number of freezings.

greater losses than the large cubes. The writer advocates as standard for freezing and thawing tests one-inch smooth cubes. The rough cubes would give higher losses, but the smooth surface of the one-inch cubes enables the disintegration to be seen more clearly by the naked eye or under the microscope than is possible with the rough cubes.



LAKE
SUPERIOR
SAND-
STONES

FROZEN 20 TIMES

BEREA
SAND-
STONE
ON LEFT

LEGRAND
LIME-
STONE
ON RIGHT

FROZEN 40 TIMES

SPECI-
MENS OF
DRY
PRESS
BUILDING
BRICK

FROZEN 20 TIMES

PLATE XXXVIII.

In plate XXXVIII some photographs of the smooth cubes subjected to the freezing and thawing tests are given. The four cubes at the top of the figure represent tests of some commonly used building stones, and are shown here for comparative purposes. These were two-inch cubes and were frozen and thawed twenty times. It will be seen that the effects were very marked. In other tests of commonly used building stones some cubes show very little effect, while in one case a cube of Joliet stone was entirely destroyed. Buff Bedford stone showed about the same effect as the cube of Berea sandstone. Blue Bedford stone was apparently unaffected, as were also some cubes of Anamosa stone and the best grades of LeGrand stone. The four two-inch cubes shown immediately below the four cubes of building stone represent freezing and thawing tests made forty times upon specimens of the dry press brick. It will be seen that double the number of exposures produced much less effect than in the tests of the building stone, and, in general, it may be said that the tests on the best grades of dry press brick compare very favorably indeed with the tests of our best building stones. In the lower part of plate XXXVIII are shown the results of twenty freezing and thawing tests of six one-inch cubes of dry press brick. The cubes shown in plate XXXVIII may be taken as representative of the results of the tests of the dry press brick.

In the climate of Iowa the freezing and thawing test is the only direct one which can be applied to building brick, to duplicate the conditions under which they fail in actual use. A close observer will readily find many instances in any Iowa town in which the ordinary building brick show serious evidences of disintegration from freezing and thawing. These effects are especially to be looked for near the ground and directly under the coping. The only objection to the freezing and thawing test for building brick is the great expense and large amount of time required to carry it out. To freeze and thaw brick forty times in the manner followed in these tests would require eighty

days of continuous test, and unless a large number could be carried through at a time the expense per test would be great.

Since these tests were completed, however, as a result of further experimenting it has been found possible to reduce the time required by one-half, by freezing one-inch cubes twenty hours each day and thawing them four hours in hot water. This method is now adopted as standard in the writer's laboratory. The use of one-inch cubes enables a very large number of specimens to be treated at one time and the result is to greatly cheapen and simplify the freezing and thawing test.

The transverse test of brick is the one most readily and cheaply made, and as it detects all hidden flaws and enables a close study to be made of the internal structure of the brick, it is of great value, although to be considered simply as an indirect test. Close observation in carrying out such tests has shown the writer that the finer grained, more uniform and dense the structure of the brick, the higher will be the transverse strength; and also, the better burned the brick is the greater will be its transverse strength. We may hence consider it to be a fair measure of the quality of the brick for ordinary purposes, and it is of especial value because it can readily be made on a large number of specimens. To indicate how well the results of transverse tests conform to the results of freezing and thawing tests, fig. 88 is given. In this figure the brick tested have been grouped in the order of their rank, as shown by the transverse tests, and the results of the freezing and thawing tests are platted on the same diagram. It will be seen that there is a general agreement between the tests, although there are wide variations from the general rule. These variations are largely to be explained, the writer thinks, by the fact that the freezing and thawing tests were made on a very small number of brick from each grade, sometimes not more than two, while the

transverse tests give the average in each case of more than twenty brick. The results of the freezing and thawing tests also are to be taken as comparative rather than absolute, because in the work of the testing some brine came in contact with the brick, and it is certain that not quite all of the salt absorbed was gotten rid of before the weighings. This fact will explain some apparent discrepancies in figs. 86 and 87.

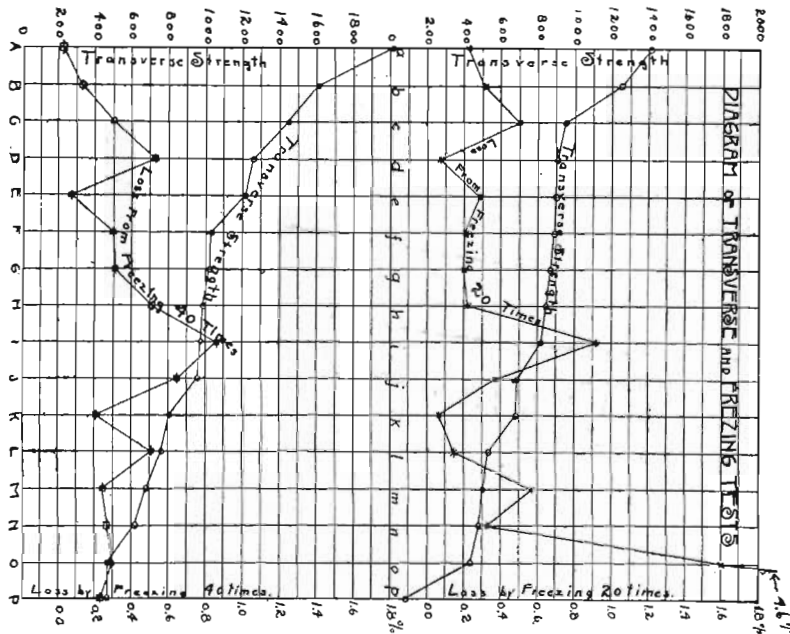

FIG. 88. Diagram showing results of transverse and freezing tests.

COMPARISON OF THE ABOVE TESTS.

To enable the comparison to be made between the results of all the different tests made on these brick, fig. 89 has been constructed. In this figure also the brick are ranked according to the results of the transverse tests, as all the other tests were made on a comparatively small number of specimens. It will be seen that there is a general agreement between the results of the different tests, with many discrepancies, however. These discrepancies are largely to be explained from the great lack

of uniformity which, as has already been shown, exists between different individual specimens of the same grade of brick, and from the fact that in all but the transverse tests only a small number of specimens were tested. The general agreement of the different tests is most readily seen by comparing the best grade with the poorest. In this case the same grade of brick

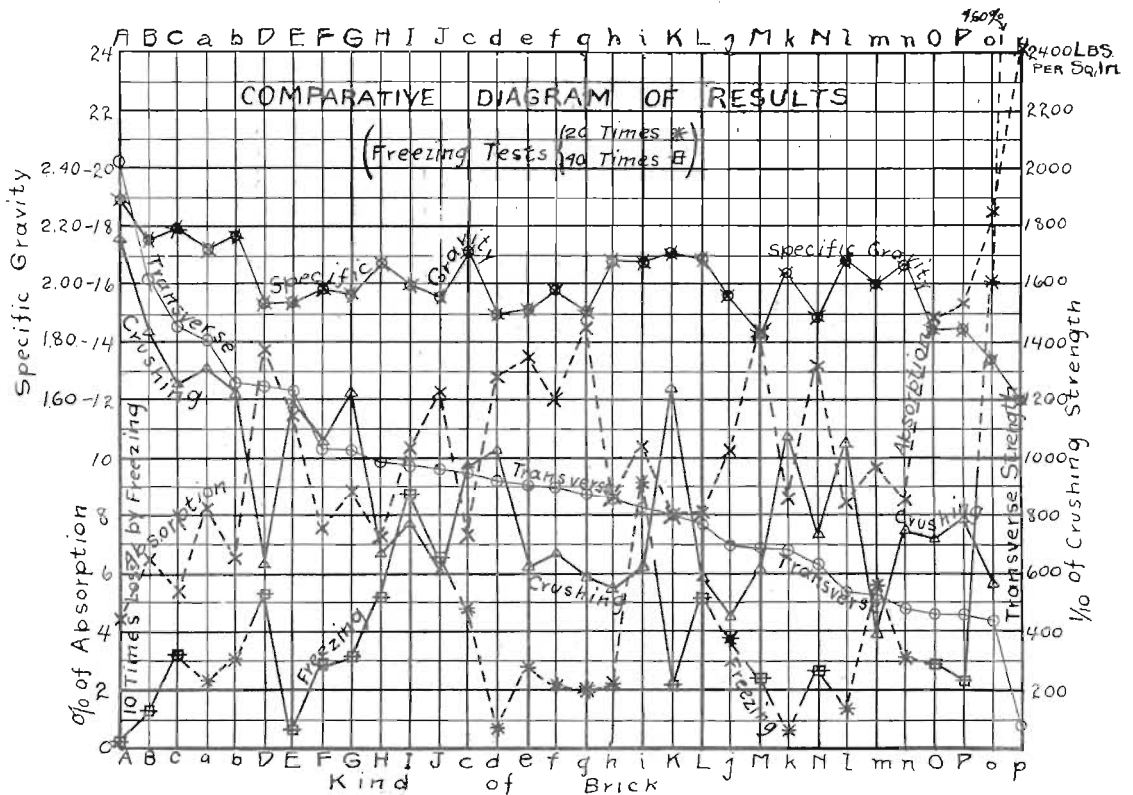

FIG. 89. Diagram showing comparative results of the different tests.

which gave the highest transverse strength had also the highest crushing strength, the lowest per cent of absorption, the smallest loss from freezing and thawing, and the highest specific gravity; while the brick which showed the lowest transverse strength was poorest in all the other tests which were made upon it. This poorest brick was one too soft to rank as

anything but an ordinary building brick, and was sent by special request made to the makers. It would probably be a better brick, however, than most of the ordinary sand brick used for building purposes in Iowa.

SUMMARY OF TESTS.

It would seem advisable to recapitulate the principal conclusions brought out by the discussion of this series of tests, as follows:

First. The best brick tested was an Iowa brick, and there appears to be no reason why the very best quality of dry press brick should not be made in Iowa.

Second. There is a great lack of uniformity in different brick from the same grade and the same kiln, and a large number of tests should be made to secure reliable deductions as to the relative rank of different grades of brick. The writer may add in this connection that in his opinion the making and interpretation of such tests should be intrusted only to experts who are perfectly familiar with the actual processes of the manufacture of brick.

Third. Crushing tests should be made upon two-inch cubes, with steel bearing plates.

Fourth. The size and character of the surface of the specimen make little difference in the results of absorption tests within the range of one-inch to two-inch cubes. Ten days immersion does not give complete saturation.

Fifth. One-inch smooth cubes should be adopted as standard for absorption and for freezing and thawing tests. These cubes should first be immersed in water and weighed, first at very short intervals, and then at longer intervals, until they are practically saturated. They should then be placed in a freezing box, in which the temperature should be 0 to 6° F. constantly maintained. This temperature can readily be attained

by the use of salt and ice. The cubes should be frozen twenty hours each day and thawed four hours in hot water having a temperature of about 150° F.

Sixth. The transverse test is one of the most valuable tests which can be made on brick. In carrying it out the brick should be placed on edge on knife edges six inches apart, rounded both ways, as for standard tests of paving brick. The pressure should be applied by a knife edge adjustable or rounded both ways, the steel bearing plates should be used between all knife edges and the surfaces of the brick. The brick should not be ground or prepared in any way for the transverse test. Careful study should be made of the internal structure of each brick in comparison with the results of the test upon it.

In conclusion the writer desires to say that the greater part of this series of tests was made by Messrs. George A. Smith, B. C. E., and F. I. Nichols, B. C. E., graduates of the Department of Civil Engineering of the Iowa State College, as thesis work. It is their earnest and painstaking work which has enabled the tests to be made.

Tests of Iowa Common Brick.

INTRODUCTION.

The following tests of common brick were carried out by the civil engineering department of the Iowa State college during the year 1902. The tests were undertaken as thesis work by Messrs. J. F. McBirney and J. E. Stewart, two senior students, who did most of the testing and calculating, and platted many of the curves. The writer desires to call especial attention to their painstaking work, and to say that without such invaluable assistance from students, given without remuneration in money, the investigations of Iowa brick heretofore reported by him, as

well as those now to be discussed, could not have been undertaken.

Previous tests of Iowa brick have been made of pavers and of dry press brick. The following tests are the first in which many data of the properties of common brick in this state have been ascertained. The greater part of the brick manufactured in the state are common brick and there is room for great improvement in the methods of manufacture. It should be understood by manufacturers and users of such brick that the testing of the product is one of the best means to bring about these improvements.

MANNER OF TESTING.

The brick were tested in four ways: viz., for transverse strength, crushing strength, percentage of absorption, and resistance to freezing and thawing. The transverse tests were made upon brick placed flatwise, on knife edges six inches apart, the knife edges being rounded both ways. Steel bearing blocks 3-4" x 3-4", a little less in length than the width of the brick, and with rounded edges, were placed between the knife edges and the brick. The crushing tests were made between adjustable steel plates, on two-inch cubes, ground out by an emery wheel. The absorption tests were made on one-inch cubes, immersed in water and weighed at intervals up to two or more weeks, but the brick are compared on the basis of forty-eight hours immersion. On the completion of the absorption tests the freezing tests were made by placing the saturated one-inch cubes in a freezing box where they were subjected to a minimum temperature of about one or two degrees above zero Fahrenheit, for twenty-four hours; then thawed in water twenty-four hours, then re-frozen twenty-four hours, etc., until the cubes were demolished.

Twenty-five bricks of each kind were broken in the transverse test. From the broken ends of ten of these the cubes were prepared for the other tests. Another set of transverse tests with the brick placed on edge was also made. In all six hundred and twenty-six transverse tests and one hundred and thirty each of crushing, absorption and freezing tests were made.

BRICK TESTED.

The brick tested were the product of seven different Iowa brick plants: viz., L. C. Besley, Council Bluffs; The Webster City Brick and Tile Company; The Dale Brick Company, Des Moines; the Goodwin Tile and Brick Company, of Grand Junction; the Mason City Brick and Tile Company, of Mason City;

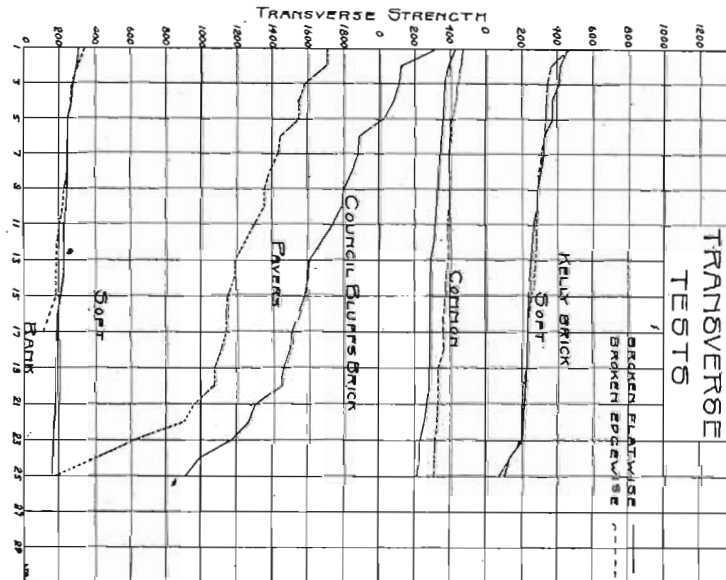

FIG. 90. Transverse tests, Council Bluffs brick.

the Kelly Brick and Tile Company, and the yard formerly operated by Mr. Cameron just west of the college. The following brief description of the clays and the processes of manufacture used in these different establishments has been prepared by Prof. S. W. Beyer.

Besley Brick.—All brick in and about Council Bluffs are made from loess clays or modified loess in the form of wash from the adjoining bluffs. Mechanical analyses show that fine sand and silt predominate with a lesser quantity of clay substance. Practically the entire mass will pass through a 100-mesh sieve. A small percentage of lime is usually present in a finely divided state and occasionally in the form of concretions and molluscan shells. Other deleterious elements are rarely present.

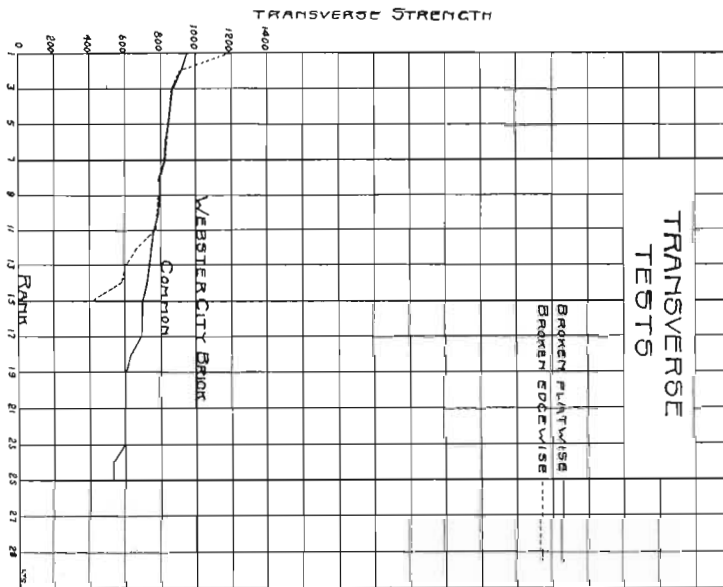

FIG. 91. Transverse tests, Webster City brick.

Webster City Brick.—Averages about one part shale obtained from the Des Moines stage of the Coal Measures to two parts surface wash and alluvium. The shale is variable in color, fissile and fairly plastic. The surface material contains a high percentage of fine sand and silt with but little clay substance, and some lime in a finely divided state.

Dale Brick (Des Moines).—The raw material is ordinary alluvium mixed with wash and loess. Sand and silt constitute the larger portion with a smaller balance of clay substance. No deleterious elements are present.

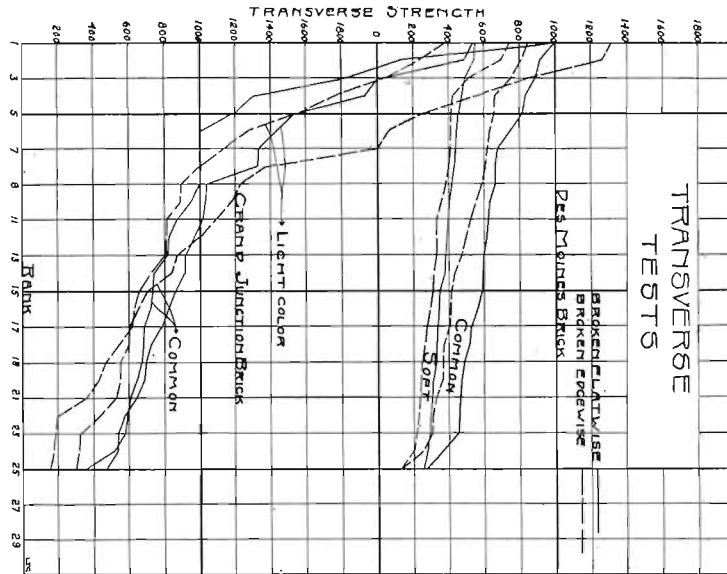

FIG. 92. Transverse tests, Des Moines brick.

Grand Junction Brick.—The raw material consists of a mixture of shale and fire clay and belongs to the Des Moines stage of the Coal Measures. The shale is slightly pyritic and moderately fissile and works into a plastic mass. The fire clay is plastic and non-fissile and more or less leached of the fluxes. The green brick is a heterogeneous mixture of the two.

Mason City Brick.—The material used is a shale clay belonging to the Line Creek stage of the Devonian. The unaltered clay is blue-gray in color, exceedingly fine-grained, highly plastic, and but imperfectly jointed, and slightly fissile. The irregular joints often contain gypsum cleavage flakes and crystals. Iron pyrite grains irregularly distributed and with the gypsum form the only grit which can be detected throughout the beds.

The upper portion of the clay beds are somewhat iron-stained to varying shades of yellow and brown, the stains following the jointings down to a considerable depth. Line in a finely divided state is present throughout the deposit.

Ames and Kelly Brick.—The material is practically the same and belongs to the loess. The beds used in each case have been

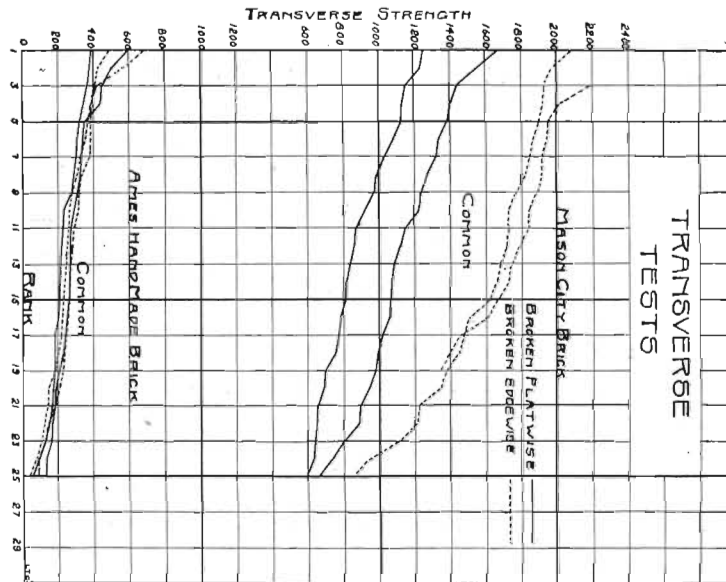

FIG. 93. Transverse tests, Mason City brick.

covered by the Wisconsin drift which necessitates considerable stripping. The loess clay at these places contains less fine sand and silt and more clay than does the Missouri river loess. It also contains more lime, both disseminated and in the form of concretions, and occasionally contains iron pyrite. Here, as is usual with loess deposits, the beds run sandier below and as in all loess clays the green ware is very tender and requires careful handling.

STRUCTURE OF BRICK TESTED.

Regarding the structure of the brick it may be said that the Council Bluffs brick were soft mud, machine made brick and were very fine-grained and homogeneous in texture, and free from laminations, the only noteworthy irregularity being the poor structure of the under side of the brick in the molds of the soft mud machine. Two grades were shipped by Mr. Besley for the tests, one grade consisting of very hard burned brick,

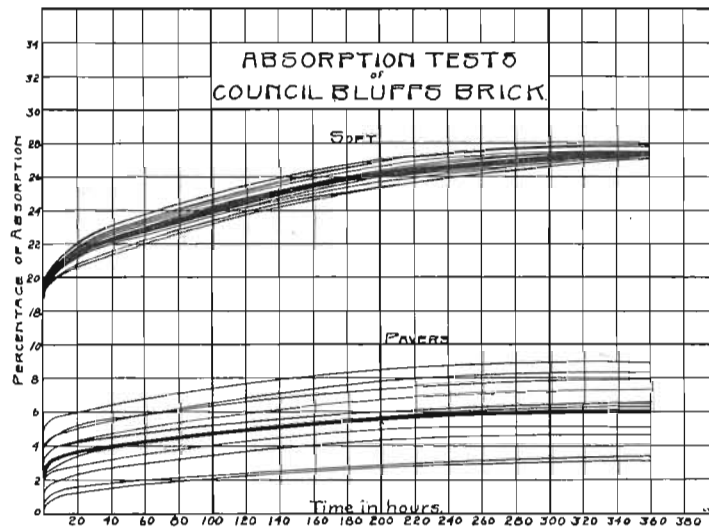

FIG. 94. Absorption tests, Council Bluffs brick.

good enough for pavers, while the other grade was composed of soft, under burned brick.

Only one grade of Webster City brick was tested and this consisted of heavy and uniformly well burned, stiff mud, side cut, brick. The interior structure showed a mixture of materials, which gave a rather loose appearing texture, but the mixture was quite uniform, the color indicated thorough burning, and the weight indicated that the porosity could not be great and the brick were hard.

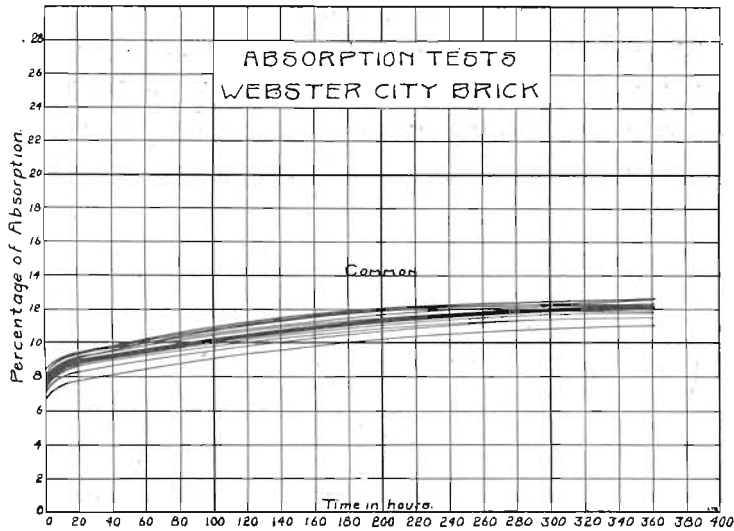

FIG. 95. Absorption tests, Webster City brick.

The Dale brick from Des Moines were selected as fairly representative of several cars shipped for the backing of the walls of the new Engineering Hall of the Iowa State College. All were stiff mud, side cut brick. Those hereinafter designated "com-

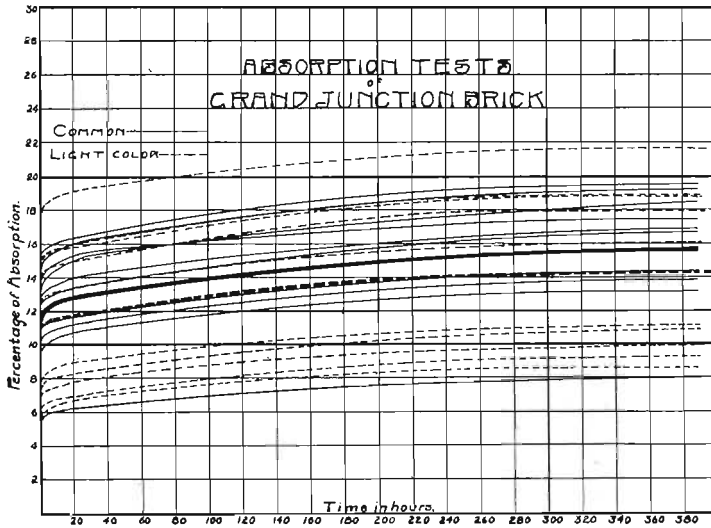

FIG. 96. Absorption tests, Grand Junction brick.

mon" were quite well burned, and of a uniformly red color, and of fairly uniform structure, although not so heavy and hard as the Webster City brick. Those Dale brick hereinafter designated "soft," were like the others except for being under burned, and in fact too soft for any use except the interior filling of walls.

The Grand Junction brick were also selected as fairly representative of some shipments for the backing of the walls of the

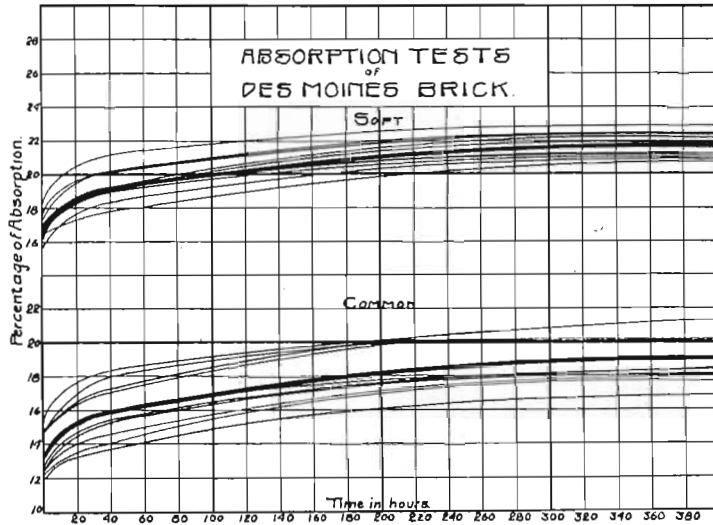

FIG. 97. Absorption tests, Des Moines brick.

Engineering Hall, and were also stiff mud, side cut brick. They were small but heavy for their size, and were made of a clay which burns to a light color, so that the lighter colored brick are the harder. The color in broken sections was quite irregular, some specimens, for example, showing a light colored external layer, then a reddish layer, and then a dark colored, blue or drab core. The color varied greatly with the different brick, however. The brick were small but heavy for their size, and quite hard. They showed some lamination. Two sets of tests

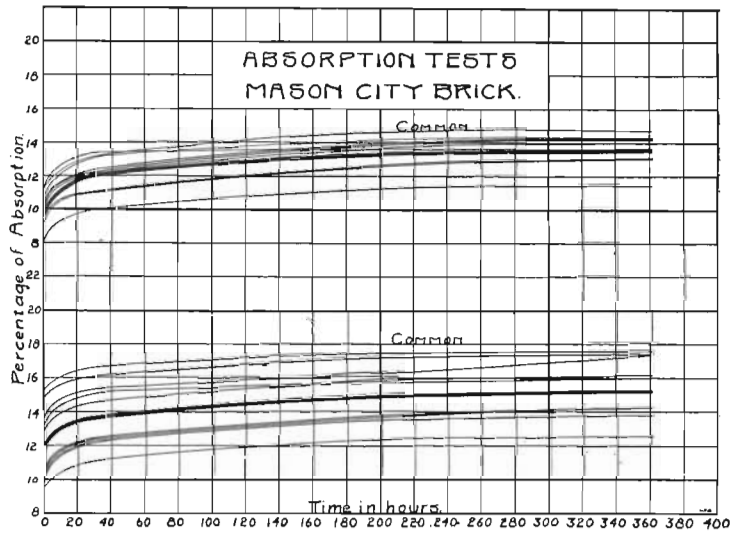

FIG. 98. Absorption tests, Mason City brick.

were made of these brick. The specimens of the two sets were not widely different in character, though probably the set marked light colored were on the average a little better burned. The Mason City brick were stiff mud, side cut brick, hard,

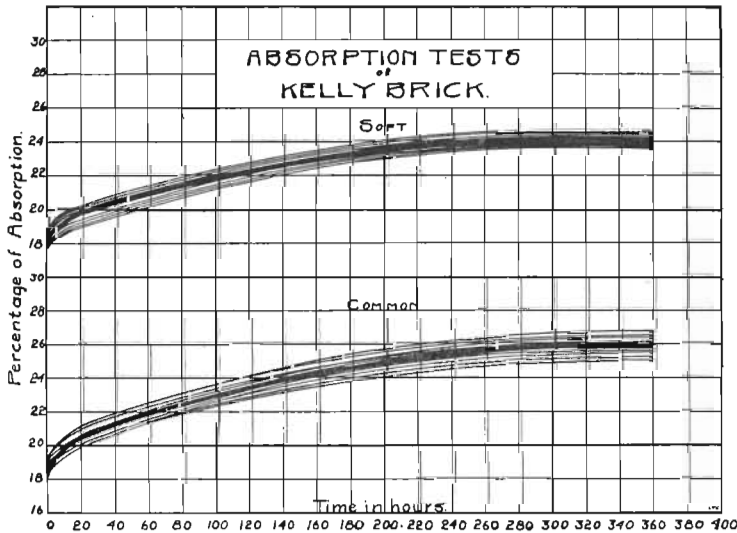

FIG. 99. Absorption tests, Kelly brick.

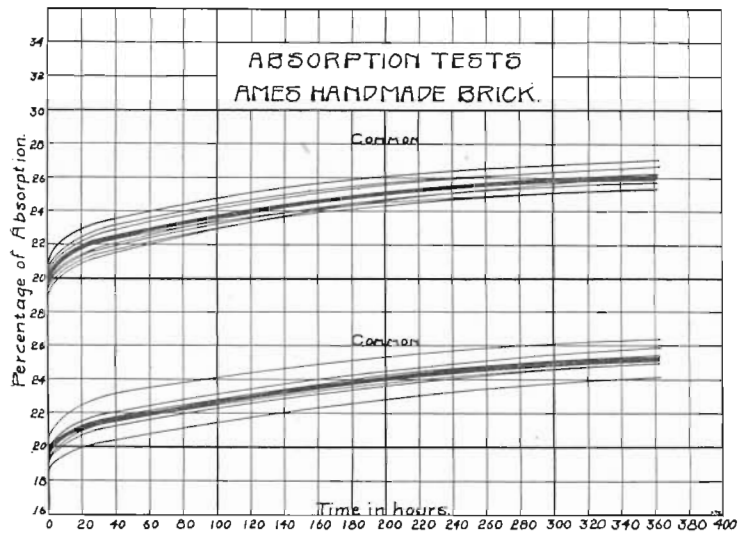

FIG. 100. Absorption tests, Ames hand made brick.

strong, heavy and moderately well burned. It was intended to test two grades, but when the brick arrived no very great difference could be detected, and the two sets of tests were on about the same grade of brick. These brick have a rather peculiar

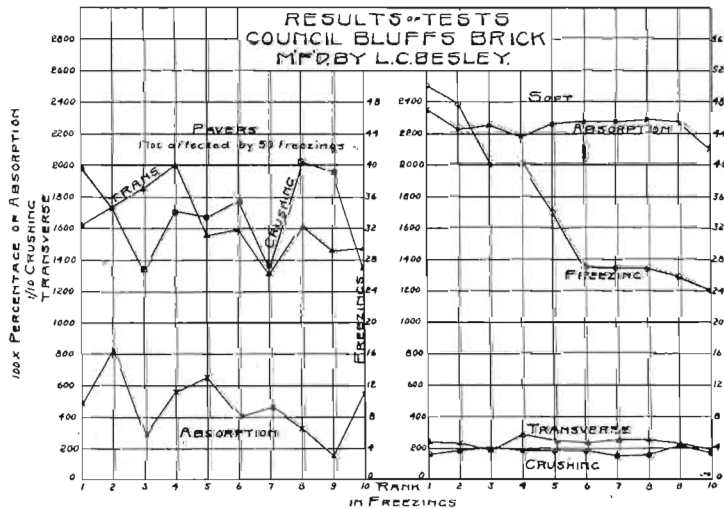

FIG. 101. Comprehensive diagram of results of tests on Council Bluffs brick.

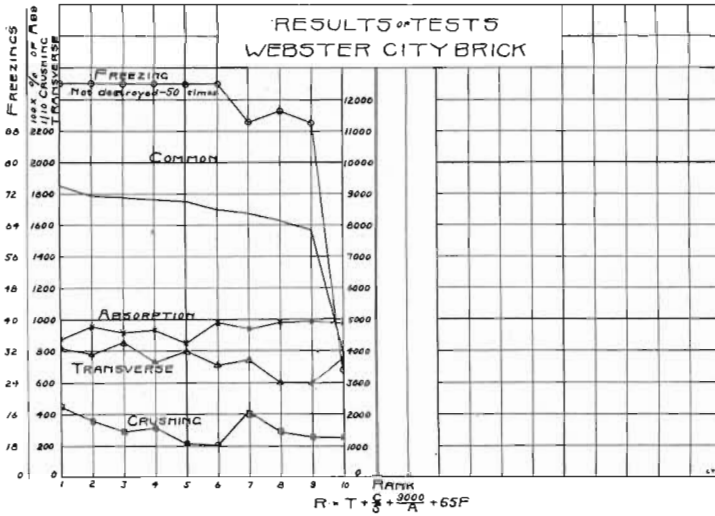

FIG. 102. Results of tests, Webster City brick.

structure. The material is evidently hard, strong, and durable, but the interior of the brick is badly laminated or fissured, up to within a short distance of those sides and ends which bear against the die in the machine. All surfaces of the brick which would be exposed in a wall, therefore, have an external layer of

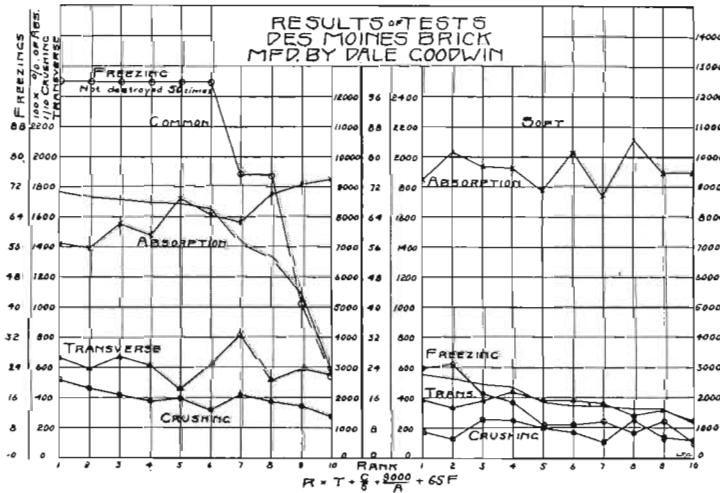

FIG. 103. Freezing tests, Goodwin brick.

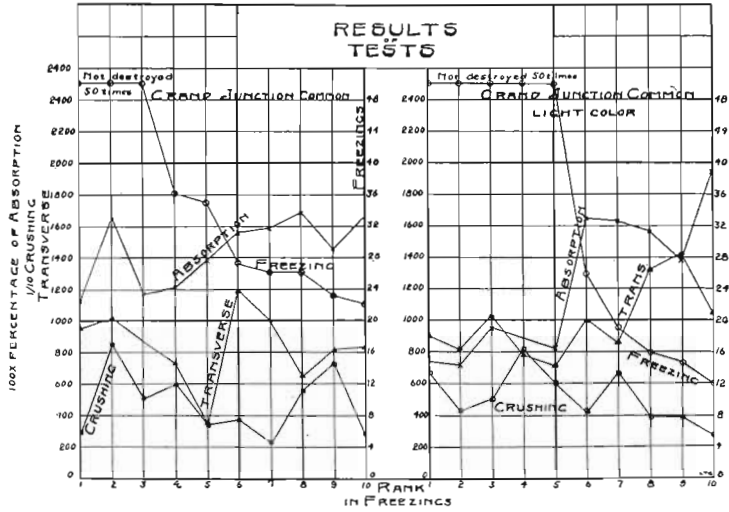

FIG. 104. Comprehensive diagram, Grand Junction brick.

extra good material. The brick were fine-grained and fairly homogeneous. The common quite frequently contained nodules of caustic lime, and the soft also contained a few such nodules, but not so many as the common.

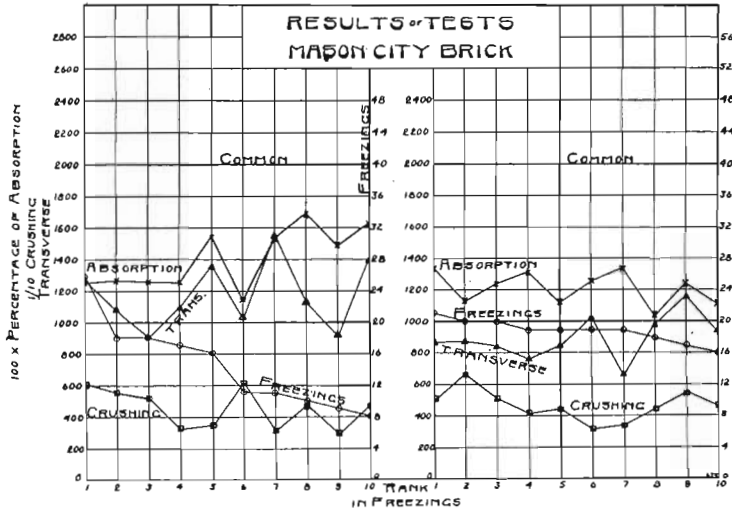

FIG. 105. Comprehensive diagram, Mason City brick.

The Ames brick were tested as representative of the old fashioned hand made, soft mud brick. The brick for the two sets of tests of Ames brick were selected from a pile delivered at a house near the college, as the yard is no longer operated. They probably represent about the best brick to be found in large percentage in the output of the yard.

RESULTS OF TRANSVERSE TESTS.

In figs. 90 to 93, inclusive, the results of the transverse tests are given. It should be clearly understood that in these diagrams, as well as in all which are to follow, it is the "modulus of rupture," i. e., the tensile stress in the outer fibre at breaking, which is shown, so that the size of the brick cuts no figure. The point of main interest in connection with figs. 90-93 is the comparison of the tensile strength of the brick when tested, first flatwise, as laid in a wall, and second, edgewise as laid in a pavement. The diagrams show no very material difference except in two instances, the Mason City common brick, and the Council Bluffs pavers. In the first of these exceptions the strength per square inch edgewise was the greater, while in the second case the strength per square inch flatwise was the greater.

In the case of the Mason City brick it is easy to see why the edgewise position should give the higher results, for in this the sound, extra good layers where the brick pressed against the die of the brick machine are put where they will do the most good, or farthest from the neutral axis. It will be remembered that the interior of these brick is badly fissured.

The Council Bluffs pavers were very hard burned, soft mud brick, and the defective side, the under side in the molds of the brick machine, was placed on top in the flatwise tests, where it would be in compression, and where the defects would have the least effect. The only difficulty in accepting this explanation for the flatwise modulus of rupture being the greater in this

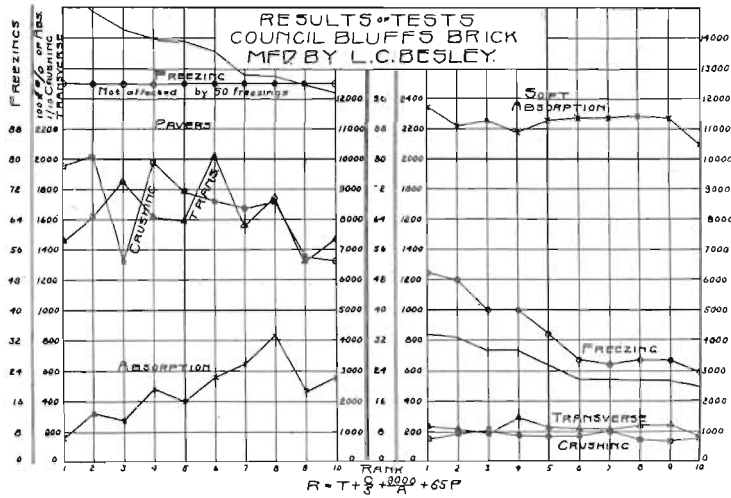

FIG. 103. Comprehensive diagram, Council Bluffs brick.

case is that we do not find the rule to hold true in the case of the soft Council Bluffs brick, nor in the case of the Ames hand made brick. Possibly the very hard burning of the Council Bluffs pavers made the defects, as would be the case with glass, very much more important as affecting the tensile strength.

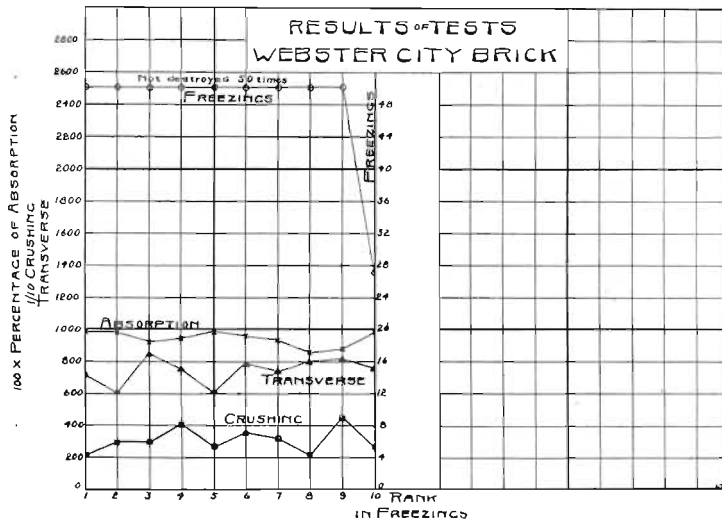

FIG. 107. Comprehensive diagram, Webster City brick.

From the results of these tests we may conclude that in transverse tests of common brick sometimes the edgewise and sometimes the flatwise position gives the greater modulus of rupture, depending on the structure of the brick, and that usually there is no very material difference.

In the diagrams which follow the modulus of rupture is from the flatwise tests.

RESULTS OF ABSORPTION TESTS.

In figs. 94 to 100, inclusive, the detailed results of the absorption tests are given. From these it is seen that when an inch cube of brick is immersed in water the absorption is at first very rapid. Within thirty minutes a large proportion of the total water eventually absorbed by the brick has been taken up. After this the rate of absorption proceeds at a continually diminishing rate until a period of from four or five up to thirty hours after the first immersion. After these initial periods a slow, steady, and very slowly decreasing additional absorption of water continues, which in nearly all the specimens was still going on after a lapse of two weeks.

Herein the brick are compared on the basis of forty-eight hours immersion. Although the final results would be ten per cent to fifty per cent greater, those for forty-eight hours were chosen because: first, the final per cents of absorption could not be obtained in any practicable test period; second, the forty-eight hours points on the absorption curves gave fair points for comparison, far enough removed from the starting points to be free from the irregularities where the curves bend rapidly; third, the water absorbed readily at first is of most importance, for brick are not usually so placed in structures as to become saturated with water, but they simply absorb part of what water is dashed against them by the storms.

As has already been indicated ten bricks were taken for each of the thirteen sets of tests made, and in each set of tests

each of the ten brick was subjected to each of the four tests, transverse strength, crushing strength, absorption, and freezing and thawing. In figs. 101-117, inclusive, the results of all these tests are shown. In further explanation it should be said that the transverse and crushing strengths are given in pounds per square inch, that the percentage of absorption is for forty-eight hours immersion of one inch, smooth cubes, and that the number of freezings platted is the number required to completely demolish a one-inch smooth cube saturated with water, the minimum freezing temperature being about two degrees above zero Fahrenheit.

RESULTS OF FREEZING TESTS.

The following should also be particularly noted in connection with the freezing tests. All ten of the Council Bluffs pavers remained practically unaffected at the end of fifty freezings,

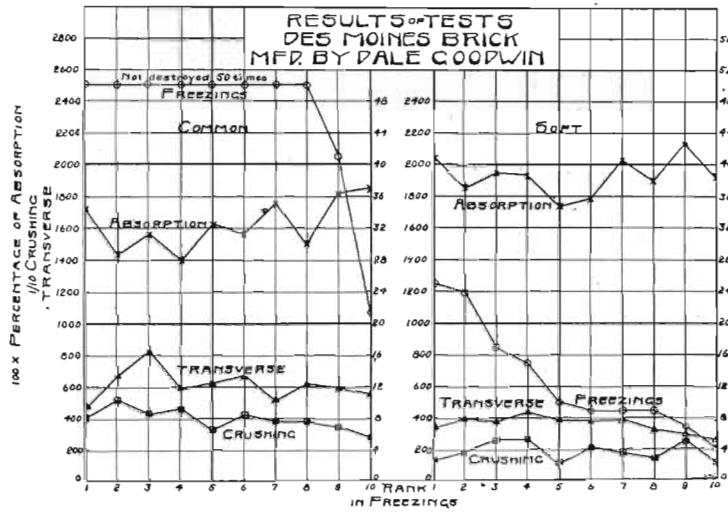

FIG. 108. Comprehensive diagram, Goodwin brick.

which was the number given all brick not demolished sooner. Of the Webster City specimens nine were not yet broken up and had lost only a small fraction of one per cent of their

original weights. Of the ten Dale common brick, six were not appreciably affected, one lost only 0.9 per cent and one 12.4 per cent. Of the ten Grand Junction brick, in the first set, one was very slightly affected, and two others lost respectively 0.8 per cent and 13.6 per cent. In the second ten, two were very little affected and three lost respectively 2.6 per cent, 6.3 per cent and 8.8 per cent. One of the surprising results of the tests described in this paper was that of the ten Kelly soft brick, three were not appreciably affected and one other was not demolished,

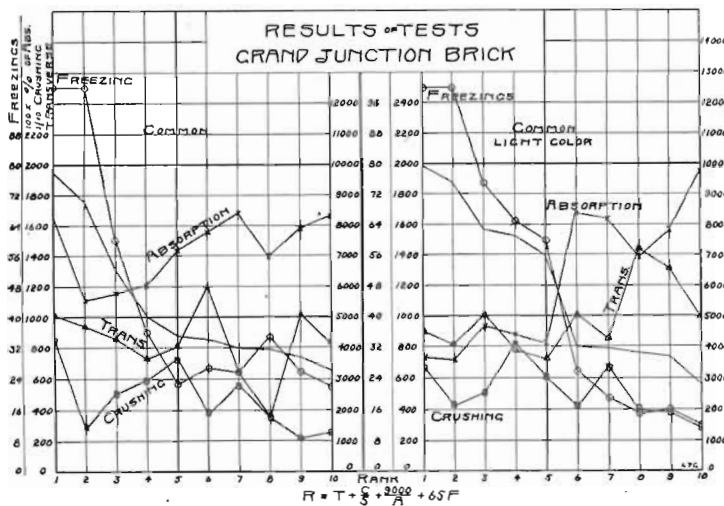

FIG. 108. Comprehensive diagram, Grand Junction brick.

though it lost 13.3 per cent of its weight. One of the second ten Ames hand made brick lost only 1.2 per cent.

In the diagrams those brick which were practically unaffected by fifty freezings were given an arbitrary rating of 100, and for the partially demolished cubes an approximate estimate was made of the number of additional freezings which would be required to totally demolish them. Of course this renders the absolute values platted for part of the freezing tests unreliable, but there is no uncertainty in the comparative results.

COMPARISON OF TESTS MADE.

In arranging all of these diagrams the aim kept in mind, in addition to showing the results in detail, was to so arrange the data that comparisons could be readily made between the results of the different kinds of tests. It was desired to ascertain conclusively whether the strongest brick would always have the lowest percentage of absorption, and especially whether it would always prove the most durable when exposed to freezing and thawing. In figs. 101 to 105, inclusive, the brick in each set of tests are arranged in the order of their resistance to freezing and thawing. In fig. 112 the average results for all ten brick of each set of tests are arranged in the order of transverse strength, and in fig. 113 in order of resistance to freezing and thawing.

By a careful study of the above diagrams some general correspondence between the results of the different tests can be traced, especially between the transverse, crushing and absorption tests, as evidenced by fig. 112, but this correspondence is only in a very general way and is subject to very many and very irregular exceptions. It is usually true that a very good brick will test better than a very poor brick in all four ways, as is seen by comparing the Council Bluffs pavers with the Council Bluffs soft, or the Dale common brick with the Dale soft, for example; but when different kinds of common brick are tested it very frequently happens that the stronger brick may not resist freezing so well as the weaker brick, and sometimes the weaker may also have a lower per cent of absorption.

To properly rank brick from the results of tests evidently requires some method which can properly take into account the results of all the tests. When we come to a consideration of this subject the question at once arises, what constitutes the value of a particular kind of brick? Obviously many things con-

tribute which are not subject to test, as, for example, regularity of form, smoothness of exterior, beauty of color, freedom from efflorescence. The qualities usually tested are strength, both transverse and crushing, and porosity. In this investigation the durability when exposed to freezing, has also been tested.

Of these three qualities strength is undoubtedly a very important quality, for a principal function of any wall is to carry weight, and the strength of a wall will depend upon the strength of the brick of which it is made. The transverse strength

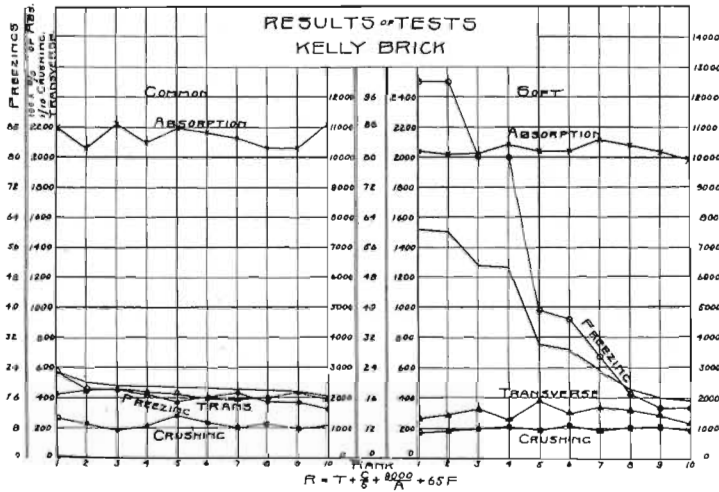

FIG. 110. Results of tests, Kelly brick.

as well as the crushing is of importance, for unsightly cracks due to uneven settlement are common and there is danger of cracks of individual brick due to imperfect bedding. The strength of the bond will also depend largely on the transverse strength of the brick.

The absorptive power of a brick is also important but not so much so as the strength. Upon the absorptive power must depend in a measure the liability to discoloration from dirt, and the more absorptive the brick the greater danger to the mortar from suction before it sets.

Undoubtedly for brick used in this climate the most important quality subject to test is the durability when exposed to freezing and thawing. It is seldom that walls fall by crushing under too great weight, while on the exterior of almost any building made of common brick a close search after a few years' exposure to our climate will disclose some evidences of disintegration.

The weight to be assigned to each of the qualities enumerated above will depend upon the use to which the brick are to be put. For example, in an interior pier not subjected to freezing at all but carrying a very heavy load, strength would be the all important quality. In other cases the resistance to freezing and thawing may be all important, and in fact is usually much more important than any other quality subjected to test. On the whole it seems fair to give strength twice the weight given to the results of the absorption test and to give the freezing and thawing test a weight equal to all of the other tests combined.

In order to prepare formulae embodying this it is necessary to know what are the average ratios between the results of the different kinds of tests. For the brick tested in these experiments the results are shown in the following table:

TABLE SHOWING COMPARATIVE RESULTS OF BRICK TESTS.

| Kind of Brick. | Transverse Strength lbs. per sq. in. | Crushing Strength lbs. per sq. in. | Per Cent Absorption | No. Freezings to Destroy 1" Cube | Ratio $\frac{C}{T}$ | Product $T \times A$ | Ratio $\frac{T}{F}$ | $R = T + \frac{C}{5} + \frac{9000}{A} + 65F$ | $R' = \frac{2T}{65} + \frac{9000}{A}$ |
|--------------------------------------|---|---------------------------------------|---------------------|-------------------------------------|---------------------|----------------------|---------------------|--|---------------------------------------|
| Council Bluffs Pavers | 1620 | 16800 | 4.7 | 100 | 10.4 | 7600 | 16.2 | 13409 | 11700 |
| Webster City Common | 740 | 3060 | 9.5 | 90 | 4.1 | 7000 | 8.2 | 8100 | 8300 |
| Dale Common | 610 | 3000 | 15.4 | 81 | 6.4 | 9400 | 7.5 | 7200 | 7100 |
| Grand Junction Lt. Col. Common | 990 | 5180 | 12.3 | 40 | 5.2 | 12200 | 20.3 | 6000 | 5900 |
| Grand Junction Common | 840 | 4720 | 13.5 | 45½ | 5.6 | 11300 | 18.5 | 5400 | 5300 |
| Grand Junction Average | 910 | 4950 | 12.9 | 47 | 5.4 | 11700 | 19.4 | 5790 | 5600 |
| Kelly Soft | 300 | 1930 | 20.5 | 51 | 6.4 | 6200 | 5.9 | 4400 | 4300 |
| Mason City Common | 890 | 4660 | 12.1 | 19 | 5.2 | 10800 | 47.0 | 3800 | 3800 |
| Mason City Common | 1170 | 4460 | 13.8 | 15 | 3.8 | 16100 | 78.0 | 3700 | 3000 |
| Mason City Average | 1030 | 4560 | 13.0 | 17 | 4.5 | 13400 | 60.6 | 3700 | 3800 |
| Council Bluffs Soft | 239 | 1790 | 22.6 | 34 | 7.8 | 5290 | 6.8 | 3200 | 3100 |
| Ames Common | 280 | 1510 | 22.7 | 31 | 5.4 | 6300 | 9.0 | 3000 | 3000 |
| Ames Common | 230 | 1470 | 21.8 | 27½ | 6.4 | 5000 | 8.4 | 2700 | 2700 |
| Ames Common Average | 250 | 1490 | 22.3 | 29 | 5.9 | 5600 | 8.6 | 2800 | 2800 |
| Kelly Common | 420 | 2240 | 21.4 | 17 | 5.3 | 9000 | 24.8 | 2400 | 2400 |
| Dale Soft | 360 | 1830 | 19.3 | 13 | 5.1 | 6900 | 27.8 | 2000 | 2000 |
| Average 6 Common | 660 | 3370 | 15.7 | 47 | 5.3 | 9400 | 21.5 | | |
| Average 3 soft | 300 | 1850 | 20.8 | 33 | 6.4 | 6000 | 13.5 | | |

It will be seen that some of these ratios are subject to wide fluctuations and the average values are not to be taken as yet well established by the results of this single series of tests.

RATING FORMULA.

For a rating formula whose coefficients are approximately determined, we may take, however,

$$R = T + \frac{C}{5} + \frac{9000}{A} + 65F,$$

In which R is a ranking number.

T—Transverse modulus of rupture in pounds per square inch.

C—Crushing strength in pounds per square inch.

A—Per cent of absorption in forty-eight hours immersion.

F—The number of freezings required to demolish a one-inch smooth cube.

In figs. 106 to 111, inclusive, the results of the individual tests are arranged according to this formula, and in the later diagrams the average results of each set of tests are arranged in similar manner. Of course the tests correspond much more nearly to the rank when arranged in this way than in figs. 101 to 105, for the results of the tests are taken into account in making the arrangement.

This subject is one which demands considerable further investigation.

Crushing tests are difficult and expensive. In case they have not been made the transverse strength may be given double weight, making the formula.

$$R' = 2T + \frac{9000}{A} + 65F,$$

In the above table the values of R' are also given and it will be seen that they rank its brick in the same order as R .

Attention is called to the results of the freezing test in the case of the Mason City brick and the Kelly brick. In the case of the Mason City brick it is undoubtedly true that the results of the freezing test did not correctly indicate the durability of the brick as they are commonly used in walls.

The structure of these brick has already been discussed and it will be remembered that the interior is considerably fissured, while the exterior surfaces which are exposed to the weather are smooth, dense and hard, and not fissured. In the freezing test the brick are saturated with water taken into the interior fissures, whereas when laid in a wall the brick could not absorb much water on account of the dense, hard exterior skin.

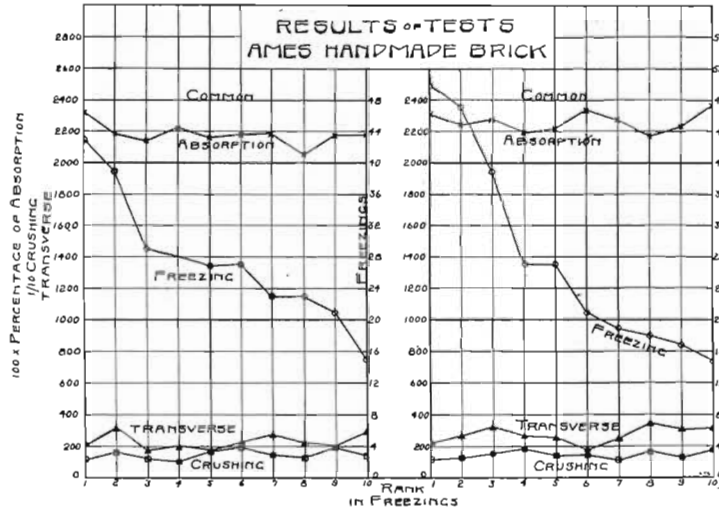

FIG. 111. Results of tests, Ames hand made brick.

In the case of the Kelly brick it was a very surprising thing that the soft brick tested better than the well burned brick as regards the per cent of absorption and especially as regards the resistance to freezing and thawing. It is very difficult to ex-

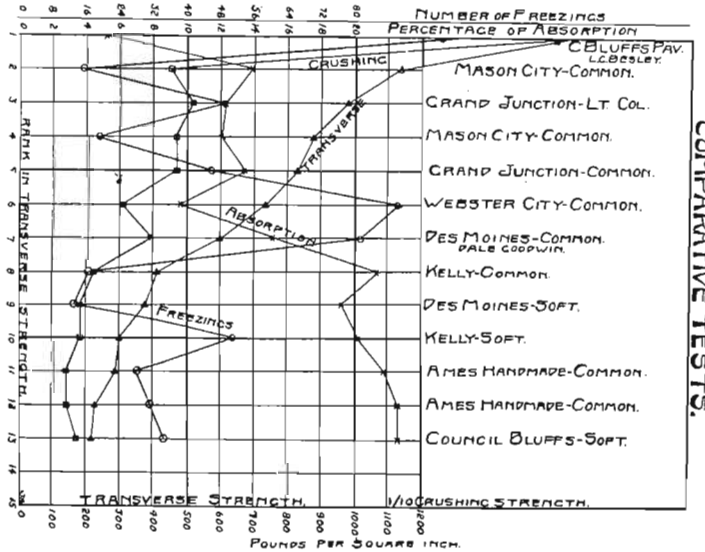

FIG. 112. Diagram showing comparative results of tests.

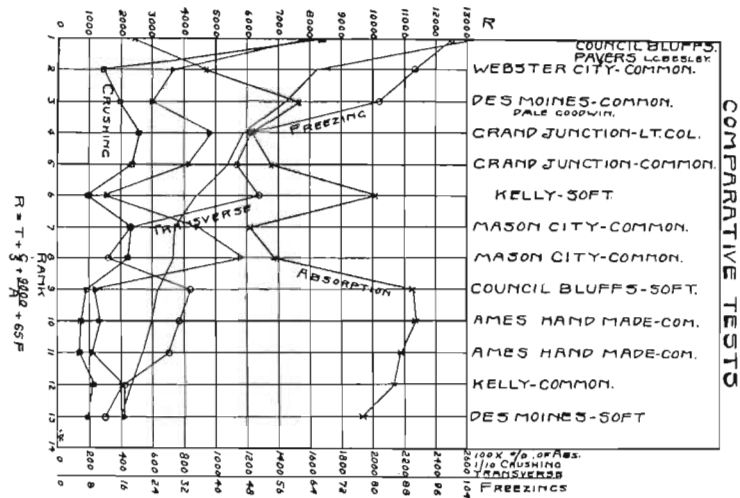

FIG. 113. Diagram of comparative results.

plain why this should be the case for the soft brick were pale and apparently not so well burned as the common brick. The only explanation which can be given by the author is perhaps that the clay of which the soft brick were made was taken from a different place in the pit and was of much better material than that from which the common brick were made. There is some in-

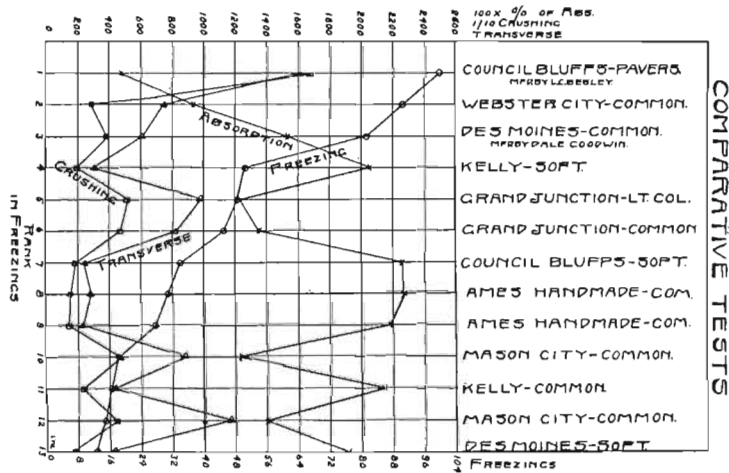

FIG. 114. Diagram of comparative results.

dication of this in the brick, for the common brick showed many more nodules of lime than the soft brick.

Tests of Strength of Hollow Building Blocks.

ADVANTAGES OF HOLLOW BLOCKS.

During the last few years there has been an extensive development in the manufacture and use of hollow clay blocks in place of solid brick for building construction. These blocks have some strong advantages in competition with brick. One is the saving in weight, which leads to economy where the material must be transported long distances. In the walls themselves the saving in weight may often be of great importance as it lessens the loads on the other parts of the building and on the foundations. Another very important advantage of hollow blocks is in the air space in the walls due to the hollow spaces in the blocks. These secure much drier walls. Another advantage is the larger size of the blocks, which permits greater rapidity in laying and makes a much smaller number of joints. Of course the greater disadvantage of brick masonry as compared with stone masonry is in the much larger number of joints imperfectly filled with mortar through which cold air may find its way.

However, hollow blocks have not been used a sufficient number of years to thoroughly demonstrate their merits and it often becomes difficult to secure their use. The principal objection which is raised to them is their lack of strength as compared with solid brick. There is no doubt that hollow blocks are much weaker than solid brick and that hollow block walls are much weaker than walls constructed of solid brick. This objection is so strongly urged that it sometimes prevents the use of hollow blocks in places where they would otherwise be adopted.

TESTS OF HOLLOW BLOCKS.

During the past few years several tests of the strength of hollow blocks have been made by the civil engineering department of the Iowa State College and for the information of manufacturers and users of building materials they are grouped in the table given below. All the tests were made by imbedding the building blocks in plaster of Paris in the 100,000 pounds testing machine of the engineering division at Ames. The blocks were imbedded in plaster of Paris both at the top and the bottom and the plaster of Paris was allowed to set usually over night. An adjustable top bearing was used to enable the machine to adjust itself to lack of parallelism of the top and bottom.

TABLE SHOWING TESTS OF IOWA HOLLOW BLOCKS.

| MANUFACTURER. | Approximate dimensions | Position. | Crushing strength tons per square foot. |
|---|------------------------|-----------|---|
| Capital City Brick and Pipe Co., Des Moines, Iowa. | 4x8x12 | Flatwise. | 78.1+* |
| | 4x8x12 | Endwise. | 230.8 |
| | 4x8x12 | Edgewise | 171.5+* |
| Mason City Brick and Tile Co., Mason City, Iowa. | 4x8x12 | Flatwise. | 64.0 |
| | 4x8x12 | Edgewise | 59.6 |
| | 5x5x12 | Flatwise. | 39.1 |
| | 4x4x12 | Flatwise. | 56.5 |
| Sioux City Brick and Tile Co., Sioux City, Iowa | 5x8x12 | Flatwise. | 30.2 |
| | 5x8x12 | Edgewise | 65.0 |
| Johnson Brothers, Kalo, Iowa | 5x8x12 | Flatwise. | 47.0 |
| | 5x8x12 | Endwise. | 131.0 |
| | 5x8x12 | Edgewise | 59.9 |
| Des Moines Clay Manufacturing Co., Des Moines, Ia | 5x8x16 | Flatwise. | 49.0 |
| | 5x8x16 | Flatwise. | 55.5+* |
| | 8x8x16 | Flatwise. | 58.0+* |

* Failed to break at full power of testing machine.

In stating the results given in the above table it may be said that architects allow five to ten tons per square foot pressure

on brick masonry. Even if this usual pressure were adopted with hollow block walls a large factor of safety would evidently be secured. Of course in walls built of hollow blocks piers of solid brick are usually built to carry concentrated loads from beams and trusses. It may be said that with proper precaution the strength of hollow blocks appears ample for all ordinary building construction.

Tests of Iowa Paving Brick.

GENERAL CONSIDERATIONS.

The manufacture of paving brick constitutes a very important part of the manufacture of clay products in Iowa. Although the use of brick paving has been very extensive it began at a comparatively recent date, and the standardizing and developing of the various tests of the material is, even yet, in an unsatisfactory state. It cannot be said that the development of satisfactory tests has kept pace with the use of paving brick.

In Iowa the manufacture and use of paving brick developed very rapidly in the few years following 1890, but, owing largely to uncertainties regarding the constitutionality of paving laws, there has been a lull in the extension of brick paving until very recently. The construction of paving is now again developing, but the brick are coming into keen competition with asphalt. The question of brick paving versus asphalt paving is one which has aroused bitter discussions in several Iowa cities during the last year or two, and it must be admitted that the use of asphalt has greatly increased recently in this state. It is easy to see why this should be the case when consideration is given to the pleasing appearance, the smooth unbroken surface and the comparatively noiseless character of the asphalt paving.

ADVANTAGES OF BRICK PAVING.

It must be admitted that brick paving has many advantages as compared with asphalt or any other form of paving, especially in the middle west, and there is practically no doubt that the construction of brick pavements will continue to be more extensive in the future. In the first place, brick is cheaper than asphalt, and this is an important consideration, especially in the cities of Iowa which have yet to construct pavements. Second, as is proven by recent tests by the civil engineering department of the Iowa State College at Ames, and by other experimenters, the traction on brick pavements is materially less than on asphalt, contrary to the common impression due to the smooth surface of asphalt pavements. Third, brick pavements do not require so high a degree of professional skill for their repair and maintenance. It is an interesting question to consider what the smaller cities of Iowa which are putting in asphalt pavements at the present time will do when the guarantee period expires and they are thrown on their own resources, or the mercy of the large corporations to repair and maintain their pavements. Fourth, the methods of construction of good brick pavement and the materials and processes can be submitted to constant direct inspection and supervision, while with asphalt entire confidence must be placed in the contractor. Fifth, brick pavement is capable of withstanding successfully heavier traffic than the asphalt, although this statement should be qualified by the statement that asphalt is suited to much heavier traffic than it was formerly supposed it could successfully stand. Sixth, brick pavements are not so slippery as asphalt pavements and can be constructed on much steeper grades.

PAVING BRICK TESTS.

The above extensive list of advantages insures that the manufacture and use of paving brick will continue to be extensive and

important in the state of Iowa. Consequently, tests of the paving brick of the state are of great interest and value, if made sufficiently numerous and with sufficient skill and care. During the last four years the civil engineering department of the Iowa State College has been engaged in making an extensive series of tests of Iowa paving brick, in all over four thousand individual tests having been made. The calculation, compilation and discussion of these tests require a vast amount of labor, which has not yet been entirely completed, so that we are now able to give only a preliminary report of the tests. In the following diagrams the principal results of these tests may be seen in the most compact form possible.

The brick for these tests were furnished by the following manufacturing companies:

Capital City Brick and Pipe Company, Des Moines, Iowa.

Merrill Brick Company, Des Moines, Iowa.

Iowa Brick Company, Des Moines, Iowa.

Flint Brick Company, Des Moines, Iowa.

Granite Brick Company, Burlington, Iowa.

Boone Brick, Tile and Paving Company, Boone, Iowa.

Each of these companies was asked to furnish three kinds of brick: first, the best or No. 1 brick, which in these diagrams is designated by the subscript "A"; second, the overburned brick, which in these diagrams is designated by the subscript "B"; and third, the underburned or soft brick, which in these diagrams is designated by the subscript "C." In the diagrams, also, for the sake of avoiding a large amount of lettering the initial letter of the company's name is used to designate the brick. Hence the following is the key to the kinds of brick given on the diagrams:

Capital City Brick and Pipe Company,

| | |
|-----------------------|----------------|
| No. 1 brick | C _A |
| Overburned brick..... | C _B |
| Soft brick | C _C |

Merrill Brick Company,

| | |
|------------------------|----------------|
| No. 1 brick..... | M _A |
| Overburned brick | M _B |
| Soft brick..... | M _C |

Iowa Brick Company,

| | |
|-----------------------|----------------|
| No. 1 brick..... | I _A |
| Overburned brick..... | I _B |
| Soft brick | I _C |

Flint Brick Company,

| | |
|-----------------------|----------------|
| No. 1 brick | F _A |
| Overburned brick..... | F _B |
| Soft brick | F _C |

Granite Brick Company, (Burlington)

| | |
|------------------------|-----------------|
| No. 1 brick | Bu _A |
| Overburned brick | Bu _B |
| Soft brick..... | Bu _C |

Boone Brick, Tile and Paving Company,

| | |
|------------------------|-----------------|
| No. 1 brick | Bo _A |
| Overburned brick | Bo _B |
| Soft brick..... | Bo _C |

An examination of the diagrams will show as a very striking fact the great lack of uniformity of the results of all paving brick tests. This same lack of uniformity is encountered by all careful experiments and is an indication of corresponding variations in the properties of the brick. It is evident, on account of this lack of uniformity, that a large number of tests should be made of each kind of brick to give results at all worthy of use.

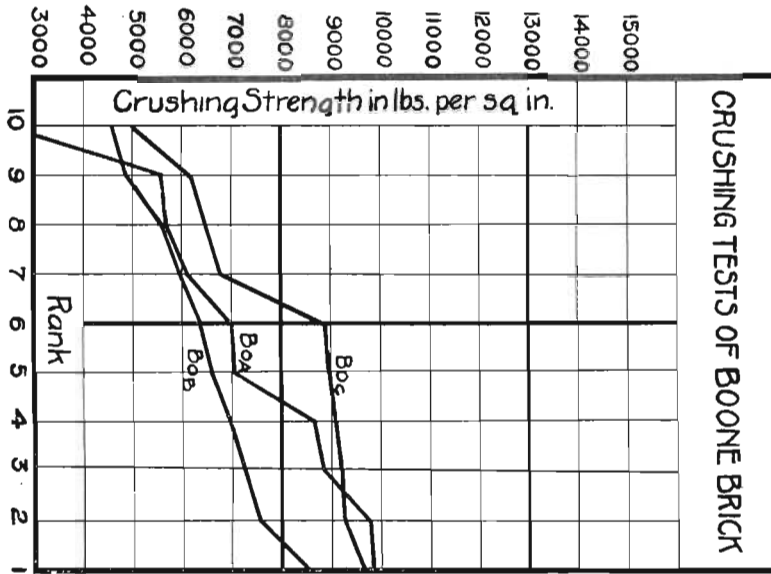

FIG. 115. Crushing tests, Boone brick.

The tests of paving brick which have been made in the past are four in number: the crushing test, the absorption test, the test of transverse strength and the rattler test.

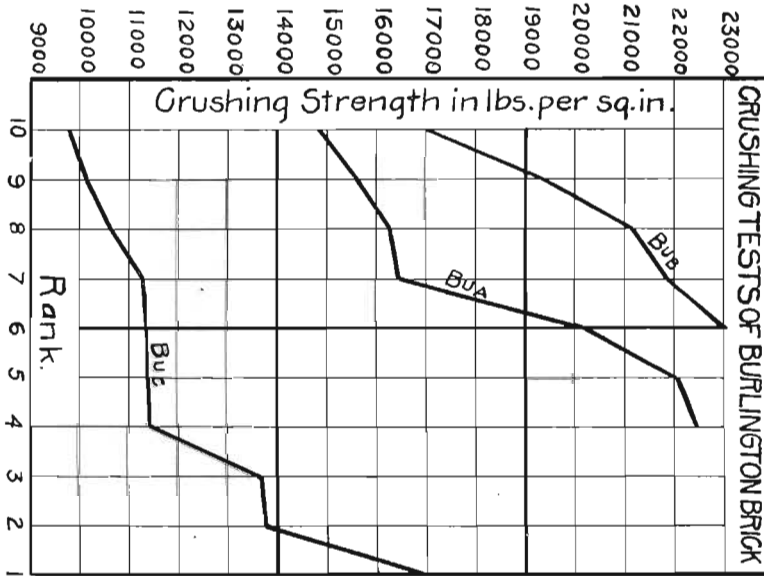

FIG. 118. Crushing tests, Burlington brick.

THE CRUSHING TEST.

The crushing test of paving brick may be said now to have been abandoned by practically all experimenters. In the inves-

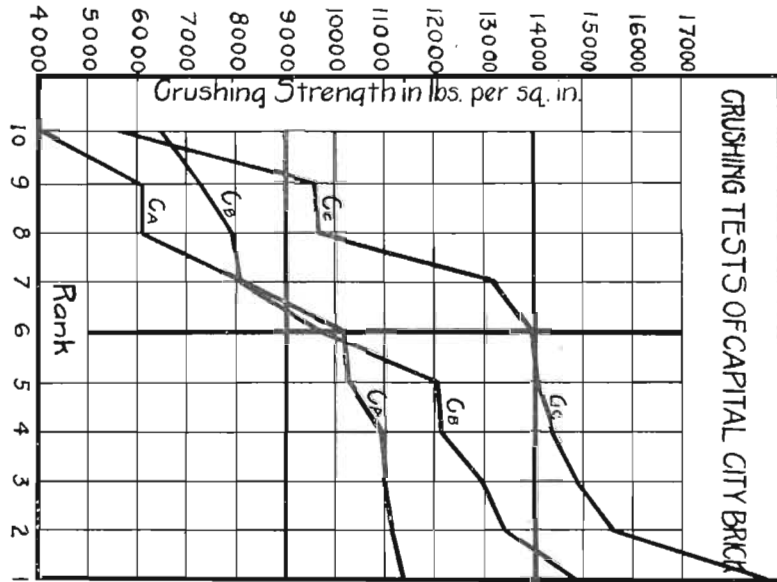

FIG. 117. Crushing tests, Capital City brick.

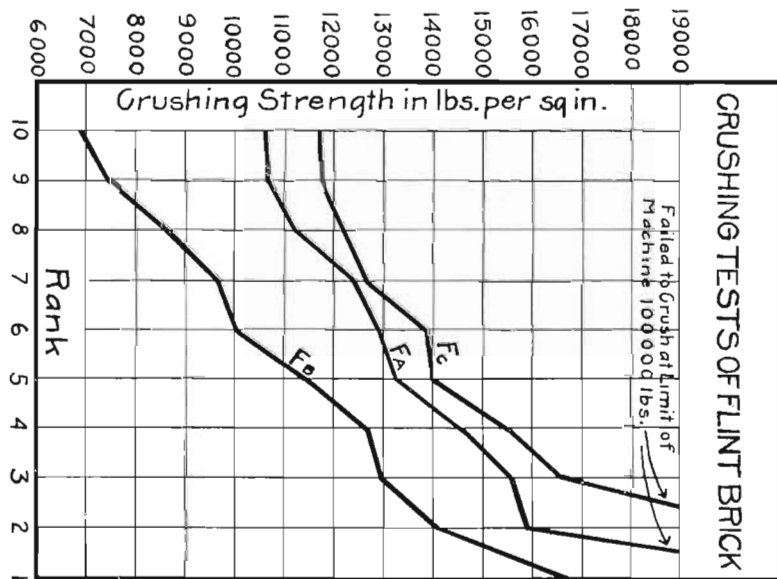

FIG. 118. Crushing tests of Flint brick.

tigation now under discussion crushing strength was determined simply as a matter of scientific interest. Paving brick never fail in the street by direct crushing and, in fact, the crushing strength of paving brick compares very favorably with the strength of granite. The test is not abandoned because its results would be of no value or interest, but because the same information can be secured by transverse tests in a much simpler and less expensive manner. The crushing test requires a very

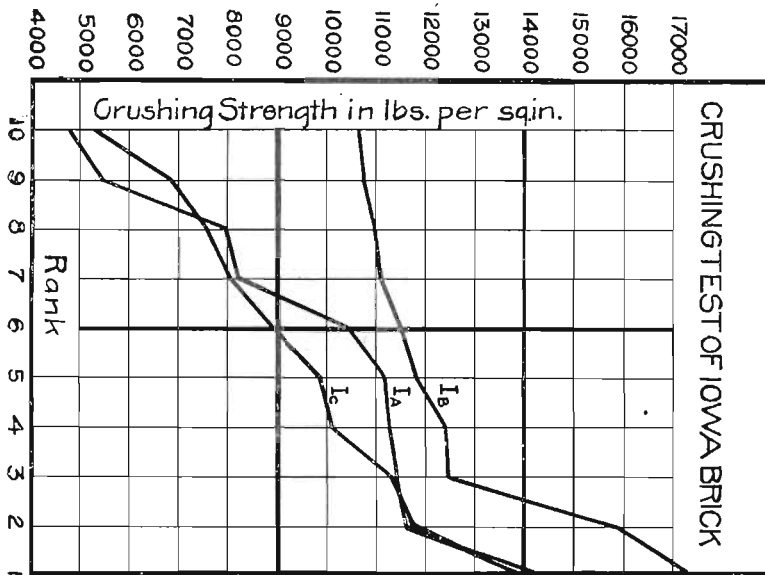

FIG. 19. Crushing tests of Iowa brick.

powerful testing machine and it is difficult and expensive to prepare the specimens for the tests. All the crushing tests in this investigation were made of ends of brick previously broken in the transverse tests. These were shaped so as to be practically square in cross section. The upper and lower edges of the brick were made respectively the upper and lower bearing surfaces in the tests. These bearing surfaces were carefully ground to true planes and in the testing machine were placed immediately

in contact with steel bearing plates. The upper bearing plate was adjustable to take care of lack of parallelism.

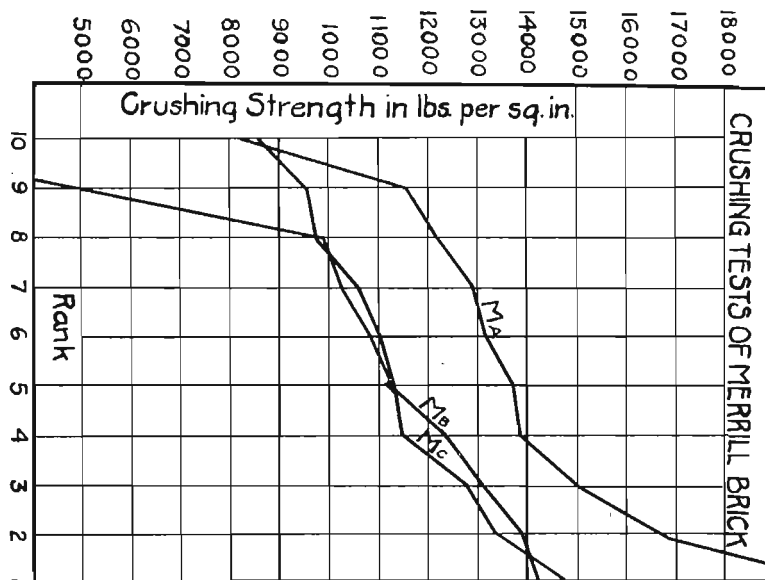

FIG. 120. Crushing tests of Merrill brick.

THE ABSORPTION TEST.

The absorption test of paving brick is of value as showing the hardness of burning of the material. However, when brick from different localities, made from different materials, are compared, the absorption test cannot be taken as a relative index of the quality, for some materials give a larger percentage than others of absorption for the same degree of vitrification. The absorption test has been standardized by the National Brick Manufacturers' Association, and these tests have been conducted in accordance with their recommendations. The tests are made of brick previously tested in the rattler tests so that the outer skin is removed. These are first placed in the oven and dried for forty-eight hours, then soaked in water and the percent of gain in forty-eight hours determined. In the tests under discussion the bricks were weighed at intervals up to many days immersion.

THE TRANSVERSE TEST.

The writer considers the transverse test of paving brick to be one of the most valuable made, although he must confess that in this opinion he is not well supported by all other experimenters on paving brick. As a result of his experience in making thousands of tests, the writer, nevertheless, believes that the transverse test furnishes fully as reliable an index of the quality of

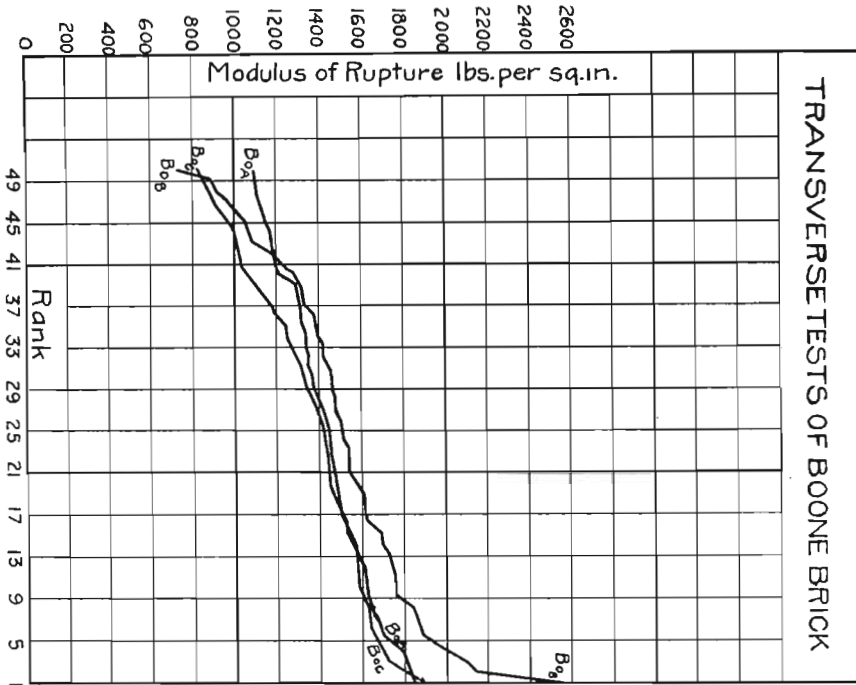

FIG. 121. Transverse tests of Boone brick.

paving brick as any yet proposed. In fact, in some cases under his observation, where the quality of the brick was known in other ways than by test, the writer has believed that the transverse test gave more accurate indications as to the relative quality of the brick than the rattler test. When we understand that actual use of brick in pavements has not always given results agreeing with the rattler tests of the material, and when we

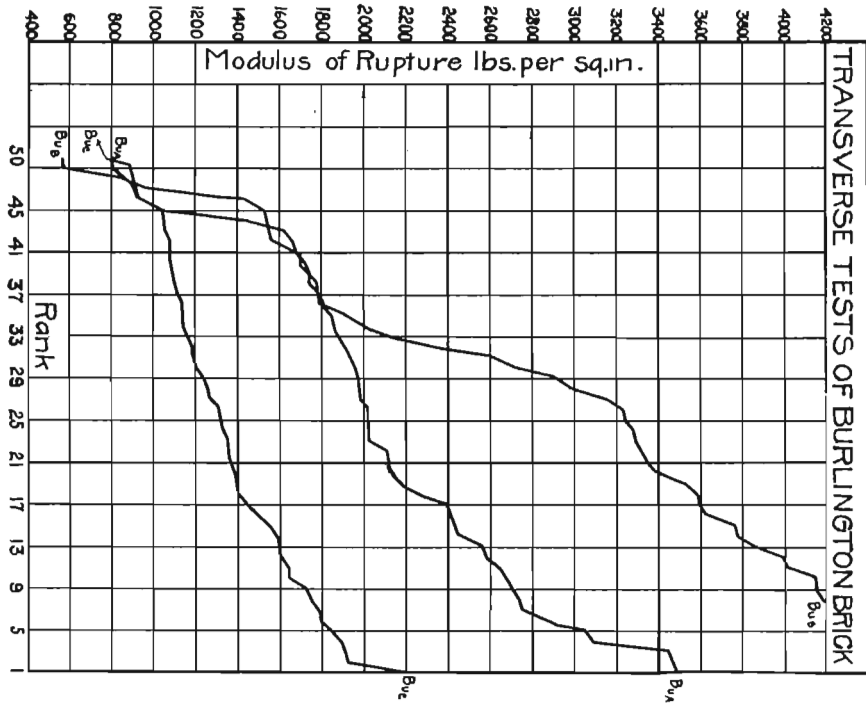

FIG. 122. Transverse tests of Burlington brick.

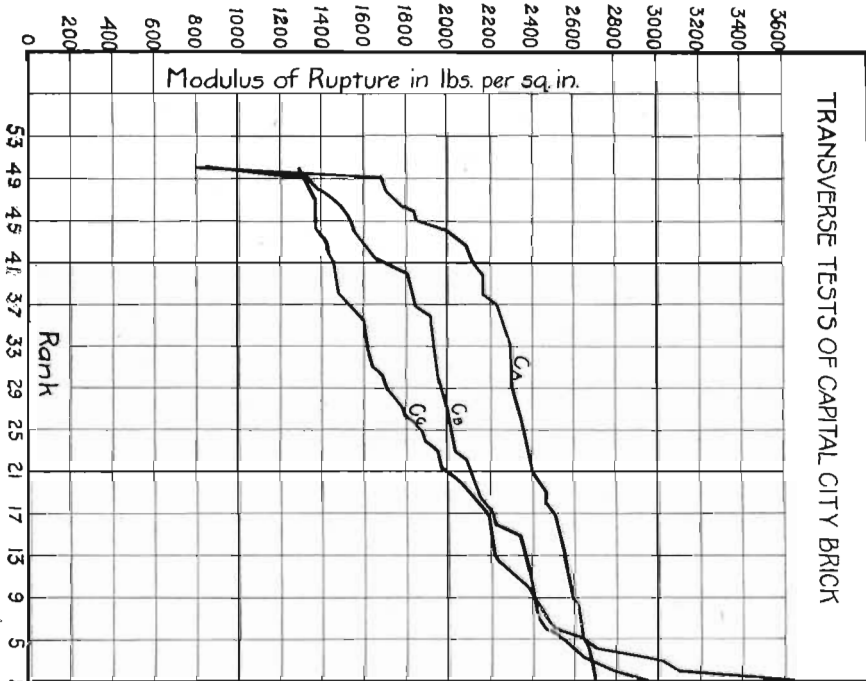

FIG. 123. Transverse tests of Capital City brick.

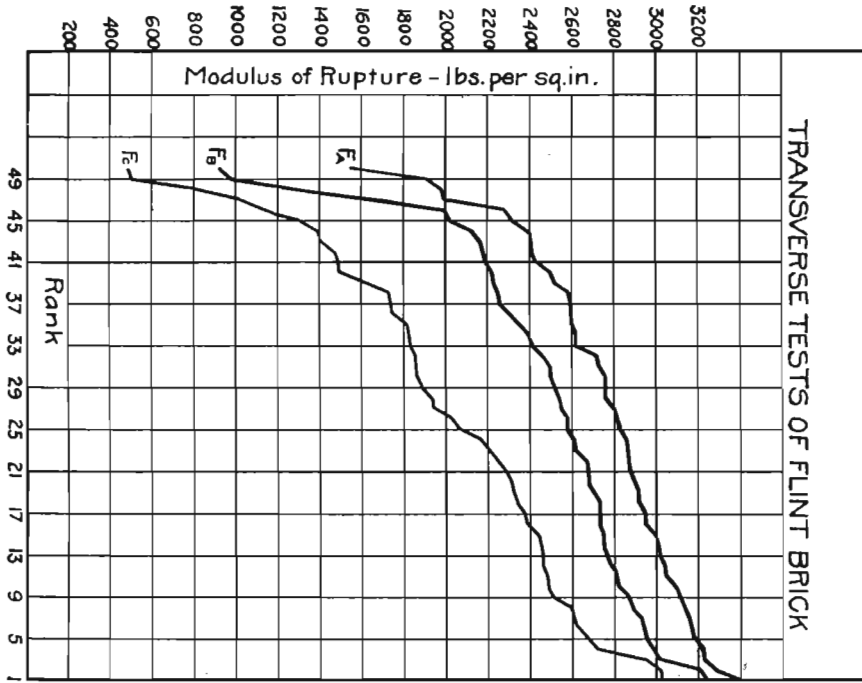

FIG. 124. Transverse tests of Flint brick.

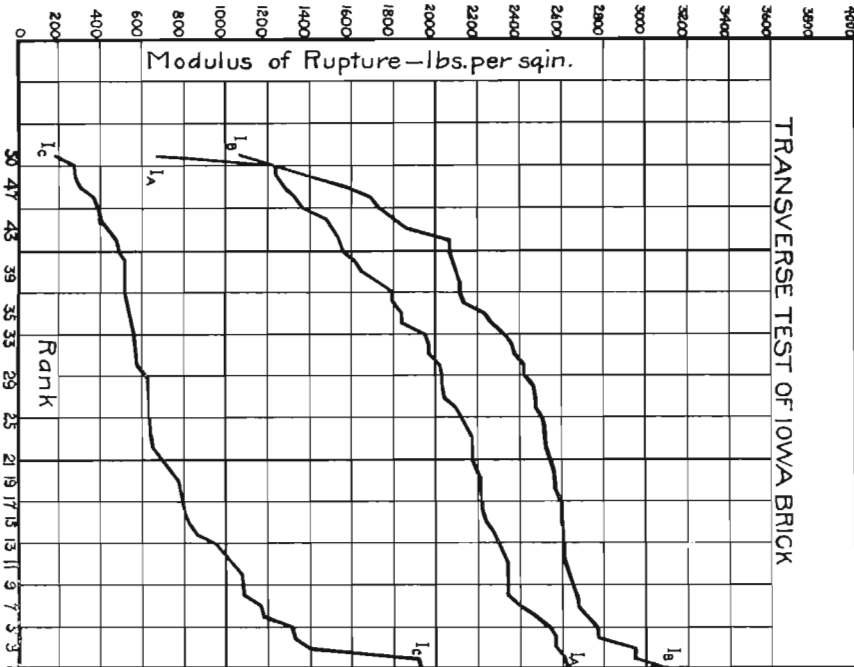

FIG. 125. Transverse tests of Iowa brick.

further have been embarrassed by the great diversity in the results of paving brick of apparently the same grade, we may well question the acceptance of the rattler tests as being infallible and of itself all-sufficient.

In the civil engineering laboratory at the Iowa State College the transverse test has been standardized in a somewhat different manner from that commonly followed by experimenters.

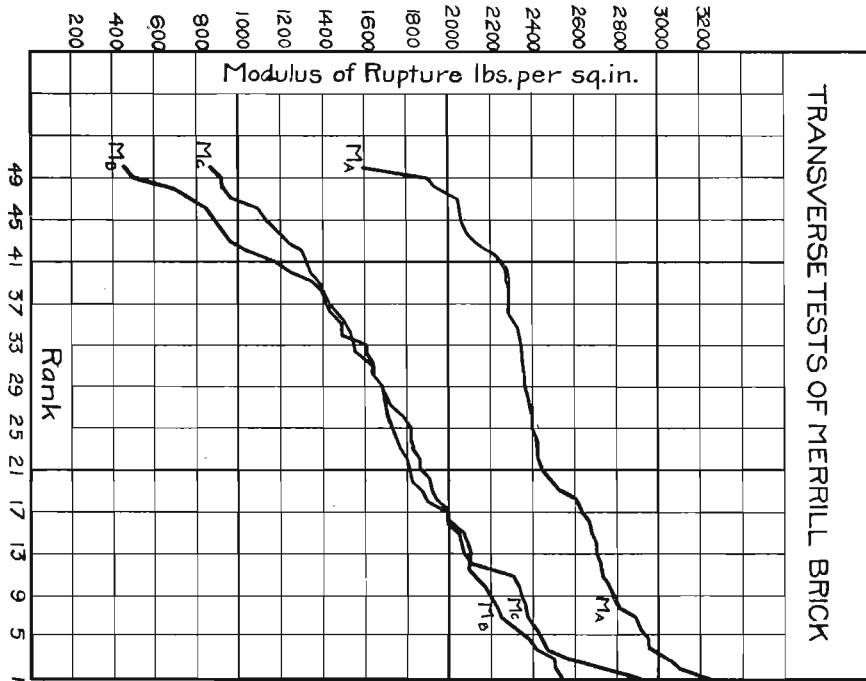

FIG. 123. Transverse tests of Merrill brick.

The brick are placed on edge, supported near each end on knife edges six inches apart rounded both ways, and the load is applied at the center by an adjustable knife edge. Between all knife edges and the brick steel bearing blocks are placed to prevent knife edges cutting into the brick.

One great advantage of the transverse test is that it fully exposes the interior structure of each brick tested and that it searches out any hidden flaws.

THE RATTLER TEST.

The rattler test of paving brick is a test not usually made of other materials of construction, but is a test which has been developed especially for this work. It has come to be considered universally the most reliable test of paving brick. In the street under actual conditions of wear brick fail mainly by abrasion from the blows of the horses' feet and the wheels of loaded vehicles. In the rattler test the brick pound against each other

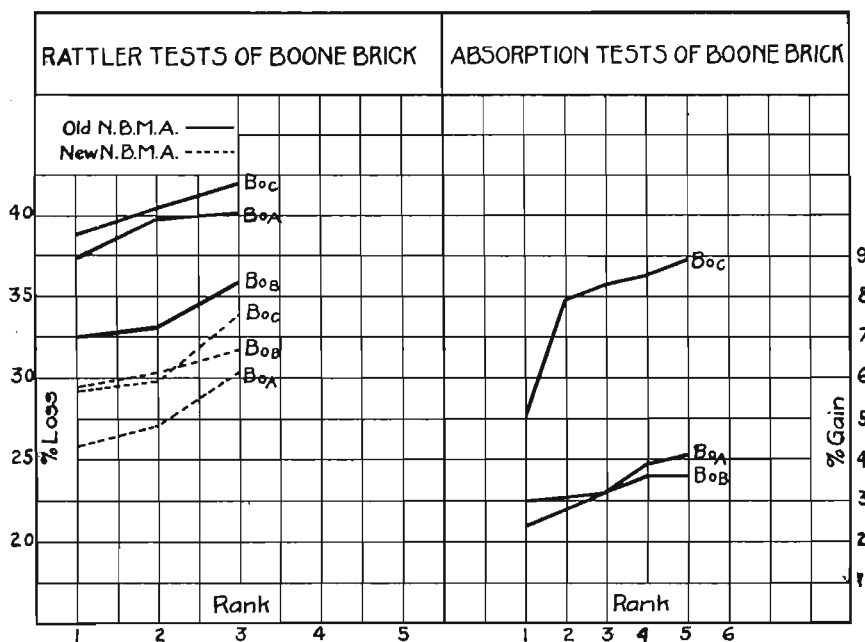

FIG. 127. Rattler and absorption tests of Boone brick.

and against the sides of the rattler, and the iron in the charge also pounds the brick in a way to produce excessive wear mainly by abrasion, and the brick fail in a manner somewhat the same as in actual use in the street.

A great deal of attention has been given to the standardizing of the rattler tests by the National Brick Manufacturers' Association, the work being done mainly by Professor Orton of the

Ohio State University. As a result of this work the National Brick Manufacturers' Association first recommended a standard method of conducting the test with the rattler containing only brick, and that these should be placed in to the extent of 15 per cent of the volume.

Experience with this method of testing soon lead to abandoning it and to the adoption of another method, which Professor

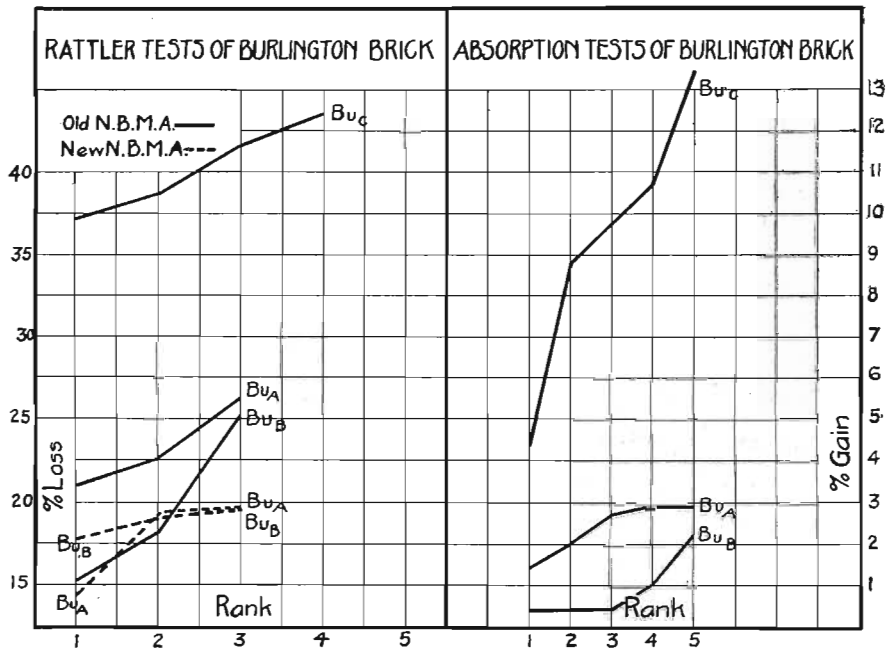

FIG. 123. Rattler and absorption tests of Burlington brick.

A. N. Talbot of the University of Illinois took a prominent part in developing. In the diagrams given herewith the method first proposed by the N. B. M. A. is designated as the "old N. B. M. A. test" and the new method as the "new N. B. M. A. test." The change was made while this investigation was under way.

Still another method of conducting the rattler test has been proposed, in which the brick are clamped around the interior perimeter of the rattler so as to make a sort of cylindrical brick

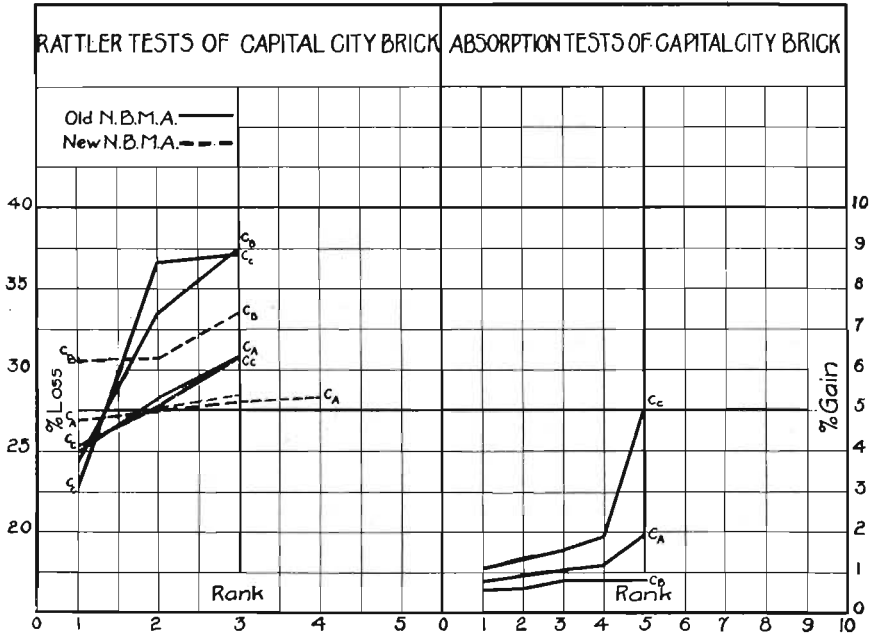

FIG. 129. Rattler and absorption tests of Capital City brick.

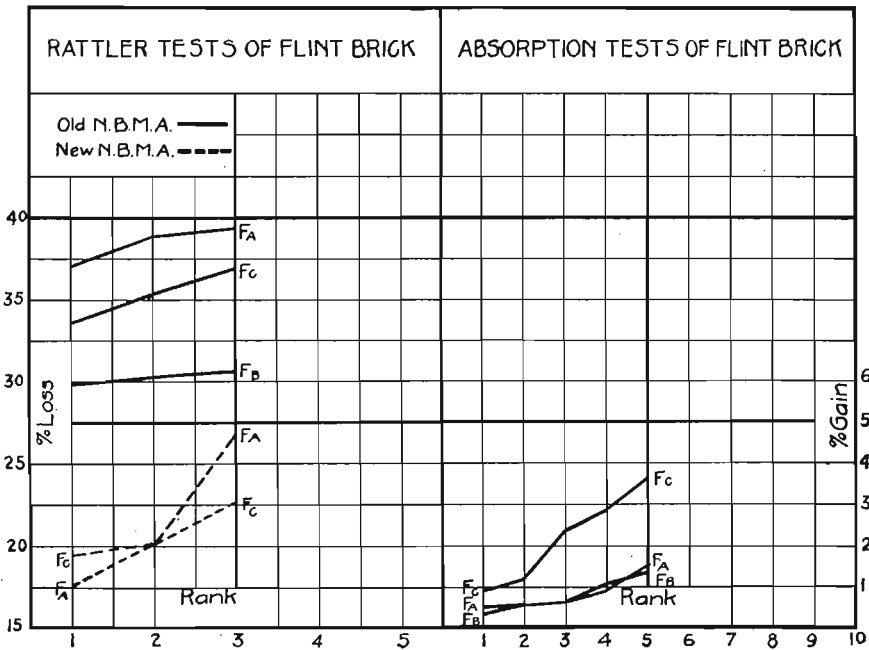

FIG. 130. Rattler and absorption tests of Flint brick.

pavement. The charge of iron in the machine then wears against only one edge of the brick in a way more closely resembling the wear in the street. In 1901 a commission of engineers consisting of the late Professor J. B. Johnson, dean of the college of engineering of the University of Wisconsin, Professor A. N. Talbot of the University of Illinois, Professor W. K. Hatt of Purdue University, and Professor A. Marston of Iowa

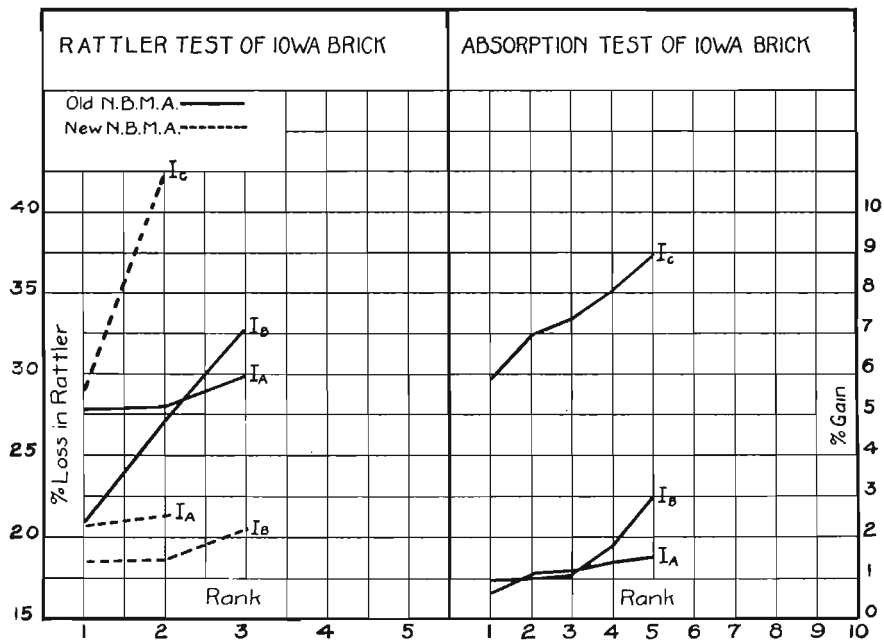

FIG. 131. Rattler and absorption tests of Iowa brick.

State College, met Professor Orton and a number of brick manufacturers, and other people interested in paving brick tests at Columbus, Ohio, to report upon the advisability of adopting this other method of testing. After careful consideration of the extensive series of tests reported, this commission advised against the adoption of the proposed method and recommended adherence to the old method, called in this paper the "new N. B. M. A. test."

It is very desirable that a standard method of conducting the rattler test should be adopted universally and it is strongly recommended that all rattler tests should be conducted in accordance with the following specifications, which have been adopted as standard by the National Brick Manufacturers' Association:

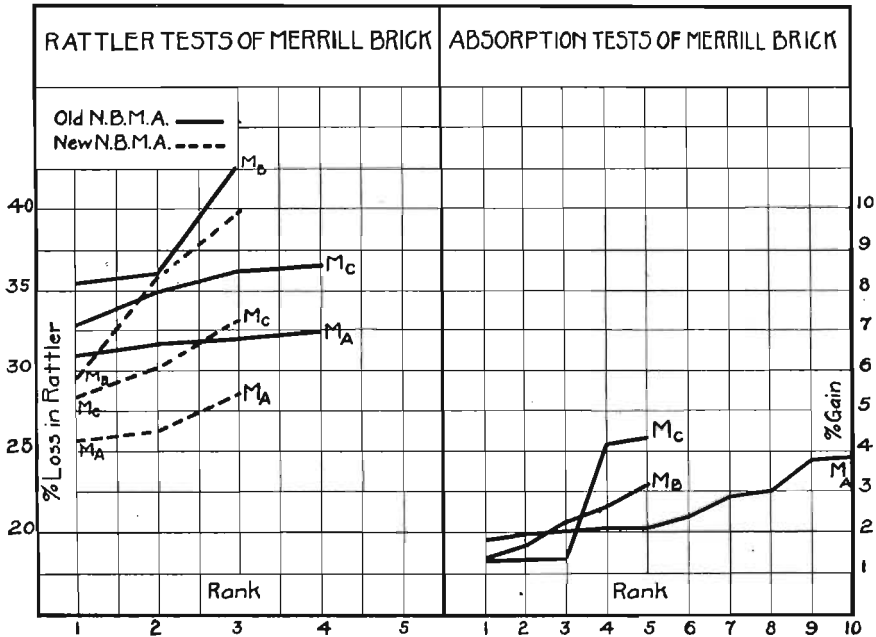

FIG. 182. Rattler and absorption tests of Merrill brick.

SPECIFICATIONS FOR STANDARD METHOD OF CONDUCTING RATTLER TESTS.

1. *Dimensions of Machine.*—The standard machine shall be 28 inches in diameter and 20 inches in length, measured inside the rattling chamber.

Other machines may be used, varying in diameter between 26 and 30 inches, and in length from 18 to 24 inches, but if this is done, a record must be attached to the official report. Long rattlers must be cut up into sections of suitable length by the insertion of an iron diaphragm at the proper point.

2. *Construction of the Machine.*—The barrel may be driven by trunnions at one or both ends, or by rollers underneath, but in no case shall a shaft pass through the rattler chamber. The cross-section of the barrel shall be a regular polygon, having fourteen sides. The heads shall be composed of gray cast-iron, not chilled nor case-hardened. The staves shall preferably be composed of steel plates, as cast-iron peans and ultimately breaks under the wearing action on the inside. There shall be a space of one-fourth of an inch between the staves for the escape of the dust and small pieces of waste.

Other machines may be used having from twelve to sixteen staves, with openings from one-eighth to three-eighths of an inch between staves, but if this is done a record of it must be attached to the official report of the test.

3. *Composition of the Charges.*—All tests must be executed on charges containing but one make of paving material at a time. The charge shall be composed of the brick to be tested and iron abrasive material. The brick charge shall consist of that number of whole bricks or blocks, whose combined volume most nearly amounts to 1,000 cubic inches, or 8 per cent of the cubic contents of the rattling chamber. (Nine, ten or eleven are the number required for the ordinary sizes on the market.) The abrasive charge shall consist of 300 pounds of shot made of ordinary machinery cast-iron. This shot shall be of two sizes, as described below and the shot charge shall be composed of one-fourth (75 pounds) of the larger size and three-fourths (225 pounds) of the smaller size.

4. *Size of the Shot.*—The larger size shall weigh about $7\frac{1}{2}$ pounds and be about $2\frac{1}{2}$ inches square and $4\frac{1}{2}$ inches long, with slightly rounded edges. The smaller size shall be $1\frac{1}{2}$ -inch cubes, weighing about seven-eighths of a pound each, with square corners and edges. The individual shot shall be replaced by new ones when they have lost one-tenth of their original weight.

5. *Revolutions of the Charge.*—The number of revolutions of the standard test shall be 1,800, and the speed of rotation shall not fall below 28 nor exceed 30 per minute. The belt power shall be sufficient to rotate the rattler at the same speed, whether charged or empty.

6. *Condition of the Charge.*—The bricks composing the charge shall be thoroughly dried before making the test.

7. *The Calculation of the Results.*—The loss shall be calculated in percentages of the weight of the dry brick composing the charge, and no result shall be considered as official unless it is the average of two distinct and complete tests, made on separate charges of brick.

While the rattler tests of Iowa paving brick are clearly shown by the diagrams given in this article, yet for the purpose of preparing specifications it is desirable that the numerical values should be available. These are presented in the following table.

In this table some rattler tests of the Purington paving brick, manufactured at Galesburg, Illinois, are also given for the purpose of comparison, because these Purington brick are so extensively used for pavements. Unfortunately we are unable to say that the Iowa brick make a better showing than the Purington brick, but it may be stated without fear of contradiction that the best grades of Iowa paving brick, as manufactured in enormous quantities at Des Moines during many years past, have demonstrated their good quality and reliability when used in brick pavements.

RATTLE TESTS OF IOWA PAVING BRICK.

PER CENT. OF LOSSES IN WEIGHT.

| KIND OF BRICK. | GRADE OF BRICK. | | | | | |
|--|------------------------|--------------------------|------------------------|--------------------------|------------------------|--------------------------|
| | No. 1. | | Overburned. | | Underburned. | |
| | Recommend- ed test. | Old N. B. M. A. test. | Recommend- ed test. | Old N. B. M. A. test. | Recommend- ed test. | Old N. B. M. A. test. |
| Flint, Des Moines..... | 17.6 | 39.1 | 37.0 | 30.6 | 22.7 | 33.5 |
| | 20.1 | 37.0 | 33.2 | 38.1 | 20.1 | 35.3 |
| | 26.8 | 38.9 | 29.8 | 31.9 | 19.5 | 36.9 |
| | | | 30.3 | | | |
| Average..... | 21.5 | 38.3 | 32.5 | 33.3 | 20.8 | 35.2 |
| Iowa, Des Moines..... | 27.5 | 27.9 | 18.5 | 32.8 | 28.8 | 36.9 |
| | 21.3 | 29.8 | 18.7 | 27.1 | 42.1 | |
| | 20.7 | 28.0 | 20.5 | 20.9 | | |
| | | | | | | |
| Average..... | 23.1 | 28.5 | 19.2 | 26.9 | 35.5 | 36.9 |
| Capital City, Des Moines..... | 26.9 | 28.3 | 30.7 | 37.5 | 27.8 | 37.2 |
| | 28.3 | 30.8 | 33.5 | 20.9 | 25.2 | 36.6 |
| | 28.1 | 24.9 | 30.5 | 24.3 | 30.9 | 22.7 |
| | | | | 33.5 | | |
| Average..... | 27.7 | 28.0 | 31.6 | 29.0 | 27.9 | 32.2 |
| Merrill, Des Moines..... | 28.5 | 32.3 | 36.5 | 42.7 | 53.2 | 32.9 |
| | 25.6 | 31.7 | 33.9 | 36.0 | 30.1 | 34.9 |
| | 26.2 | 31.0 | 39.3 | 35.5 | 28.4 | 36.2 |
| | | 32.0 | | | | 36.5 |
| Average..... | 26.7 | 32.3 | 36.6 | 38.0 | 30.6 | 35.1 |
| Burlington..... | 19.7 | 26.3 | 17.6 | 18.1 | 34.7 | 37.2 |
| | 14.4 | 21.0 | 19.3 | 25.3 | | 38.8 |
| | 19.3 | 27.6 | 29.1 | 15.3 | | 43.6 |
| | | | | | | 41.7 |
| Average..... | 17.8 | 25.0 | 18.6 | 19.6 | 34.7 | 40.3 |
| Boone..... | 30.3 | 39.8 | 31.7 | 35.9 | 29.8 | 40.4 |
| | 28.8 | 37.4 | 30.3 | 32.5 | 29.2 | 38.7 |
| | 27.2 | 74.2 | 29.5 | 33.1 | 33.6 | 41.9 |
| | | | | | | |
| Average..... | 28.7 | 39.1 | 30.5 | 33.8 | 30.9 | 40.3 |
| Purinton Paving Brick, Galesburg, Illinois..... | | 17.8 | | 19.0 | | 16.3 |
| | | 18.9 | | 20.1 | | 22.8 |
| | | 19.0 | | 22.0 | | 30.6 |
| | | 20.3 | | | | |
| Average..... | | 19.0 | | 20.4 | | 23.2 |

DIRECTORY OF IOWA CLAY WORKERS

BY

S. W. BEYER AND I. A. WILLIAMS.

DIRECTORY OF IOWA CLAY WORKERS.

ADAIR COUNTY.

| FIRM NAME. | LOCATION OF PLANT. | MATERIAL USED. | PROCESS. | DRYER. | KILNS. | PRODUCTS. |
|----------------------|--------------------|----------------|---------------------|--------|------------------------------------|---|
| C. H. Cass | Bridgewater | Loess | Soft and stiff mud. | | 1 up and down draft..... | Common brick, hollow block, drain tile. |
| Ledman & Strong..... | Bridgewater | Loess | | | | Common brick. |
| J. W. Darby | Greenfield..... | Loess | Dry press .. | | 2 round down draft and 1 up draft. | Front brick and drain tile. |

ADAMS COUNTY.

| | | | | | | |
|----------------------------------|------------------|-------------|----------------|------------------|-------------------------|------------------------------|
| Davy Burnt Clay Ballast Company. | Corning | Loess | | | | Burnt clay ballast. |
| W. Newcomb & Co..... | Corning | Loess | Soft mud..... | | 5 Stewart down draft .. | Common brick. |
| A. C. Peter-on..... | Mount Etna | Loess | Soft mud..... | | Open | Common brick. |
| M. F. Trabert..... | Prescott..... | Loess | Soft mud..... | Pallet | 3 clamp..... | Common brick. |
| E. W. & G. A. Gillet..... | Corning | Loess | Stiff mud..... | Rack and pallet. | 3 clamp..... | Common brick and drain tile. |

APPANOOSE COUNTY.

| | | | | | | |
|-------------------------------------|------------------|----------------------|-----------------|-------|-------------------------|-------------------------|
| Centerville Brick and Tile Co. | Centerville..... | Coal measure shales. | Dry press | | 1 continuous kiln | Common and front brick. |
|-------------------------------------|------------------|----------------------|-----------------|-------|-------------------------|-------------------------|

AUDUBON COUNTY.

| | | | | | | |
|---------------------------|---------------|-------------|-----------------|-------|-------------------------|------------------------------|
| L. E. Tramp & Tramp | Audubon. | Loess | Stiff mud | | 4 round down draft..... | Common brick and drain tile. |
|---------------------------|---------------|-------------|-----------------|-------|-------------------------|------------------------------|

BENTON COUNTY.

| | | | | | | |
|-----------------------------------|-------------------|-------------|---------------------|-------|---------------------------|------------------------------|
| R. F. Smith..... | Belle Plaine..... | Loess | Soft mud..... | | Up draft | Common brick. |
| Garrison Brick and Tile Company.. | Garrison | Loess | Stiff mud | | 3 round down draft..... | Common brick and drain tile. |
| E. A. Peacock..... | Newhall..... | Loess | Stiff mud | | 2 down draft..... | Drain tile. |
| Chas. Trojorsky | Norway..... | Loess | Soft and stiff mud. | | 2 round down draft | Common brick and drain tile. |
| Samuel Shannon..... | Shellsburg | Loess | Dry press | | 1 down and 1 up and down. | Common brick and drain tile. |
| David Aikley..... | Vinton | Loess | Soft mud | | 2 clamp | Common brick and drain tile. |

DIRECTORY OF IOWA CLAY WORKERS—CONTINUED.

BLACK HAWK COUNTY.

| FIRM NAME. | LOCATION OF PLANT. | MATERIAL USED. | PROCESS. | DRYER. | KILNS. | PRODUCTS. |
|------------------------------------|--------------------|-------------------------|-----------------|----------------|--------------------------|---------------|
| Waterloo & Cedar Falls Brick Co... | Cedar Falls | Kansan and Iowan drift. | Stiff mud | Phillips | Up draft and down draft. | Common brick. |
| Stead Brothers & Guenther..... | Waterloo | Loess | Stiff mud | | 3 round down draft | Common brick. |

BOONE COUNTY.

| | | | | | | |
|------------------------------------|----------------|----------------------|-----------------|---------------|----------------------------------|--|
| Boone Brick, Tile and Paving Co... | Boone | Coal measure shales. | Stiff mud | Tunnel dryer. | 10 round down draft... | Common brick and drain tile. |
| A. E. Goldthwaite..... | Boone | Wisconsin drift. | Soft mud.... | | Up draft..... | Paving brick and common brick. |
| McHose Brothers | Boone | Shale | Stiff mud | Tunnel dryer | 5 round and 2 square down draft. | Common brick, drain tile and fire brick. |
| Fred Carlson | Madrid | Drift and wash. | Soft mud.... | | 2 up draft, 1 down draft. | Common brick. |
| John Slater..... | Moingona | Drift and wash. | Soft mud | | 2 up draft, 1 down draft. | Common brick. |
| Scandia Brick and Tile Company.. | Madrid | Shale | Stiff mud | | 2 round down draft | Common brick and drain tile. |

BREMER COUNTY.

| | | | | | | |
|----------------------------------|---------------|-------------|----------------|-------|---------------|---------------|
| Waverly Brick and Tile Company.. | Waverly | Loess | Soft mud.... | | Clamp..... | Common brick. |
| Henry Cretzmeier..... | Waverly | Loess | Soft mud | | Up draft..... | Common brick. |

BUENA VISTA COUNTY.

| | | | | | | |
|-------------------------------------|--------------------|---------------------------|-----------------|-------|--------------------------|------------------------------|
| Linn Grove Brick and Tile Co. | Linn Grove | Wisconsin drift and wash. | Stiff mud | | 2 down draft..... | Drain tile and common brick. |
| Storm Lake Brick and Tile Works. | Storm Lake..... | Drift | Stiff mud | | 3 round down draft | Common brick and drain tile. |
| Sioux Rapids Brick and Tile Factory | Sioux Rapids | Drift and wash. | Stiff mud | | 2 round down draft | Drain tile. |

BUTLER COUNTY.

| | | | | | | |
|-------------------------|---------------|--------------|----------------|-------|-------------------|---------------|
| L. M. Harris & Son..... | Clarkville... | Iowan drift. | Stiff mud | | Scove No. 2 | Common brick. |
|-------------------------|---------------|--------------|----------------|-------|-------------------|---------------|

CALHOUN COUNTY.

| | | | | | | |
|-----------------------------|--------------------|--------------------|----------------|-------|------------------------|---|
| Lake City Clay Works..... | Lake City..... | Cretaceous shales. | Stiff mud | | 8 round down draft ... | Common brick, drain tile, and sidewalk brick. |
| Steinberger & Marriott..... | Rockwell City..... | Wisconsin drift. | Stiff mud | | 8 down draft .. | Drain tile. |
| Manson Clay Works..... | Manson..... | Wisconsin drift. | Stiff mud | | 2 round down draft ... | Drain tile. |

CARROLL COUNTY.

| | | | | | | |
|--------------------------|--------------|------------|-------|-------|-------|---------------|
| O'Neal & Kallenberg..... | Carroll..... | Loess..... | | | | Common brick. |
|--------------------------|--------------|------------|-------|-------|-------|---------------|

CASS COUNTY.

| | | | | | | |
|------------------------------------|---------------|------------|----------------|-------|-------------------|---------------|
| C. L. Martin..... | Anita..... | Loess..... | Soft mud | | 4 up draft. | Common brick. |
| Chas. E. Taylor Brick Company..... | Atlantic..... | Loess..... | Stiff mud | | 8 down draft..... | Common brick. |

CEDAR COUNTY.

| | | | | | | |
|----------------------|-------------|------------|----------------|-------|-------------------------|------------------------------|
| Geo. H. Kettell..... | Tipton..... | Loess..... | Stiff mud | | 2 Platt, 1 common. | Common brick and drain tile. |
|----------------------|-------------|------------|----------------|-------|-------------------------|------------------------------|

CERRO GORDO COUNTY.

| | | | | | | |
|--|-----------------|----------------------|----------------|---------------|---------------------|---|
| American Brick and Tile Company..... | Mason City..... | Devonian shales. | Stiff mud | Tunnel dryer. | 10 down draft. | Common brick, drain tile hollow block. |
| Mason City Brick and Tile Company..... | Mason City..... | Devonian shales. | Stiff mud | Tunnel dryer. | 18 down draft .. | Common brick, drain tile, hollow block, and radial stack block. |
| Mason City Clay Works..... | Mason City..... | Devonian shales..... | Stiff mud | Tunnel dryer | 8 down draft..... | Common brick, drain tile, hollow block. |

CHEROKEE COUNTY.

| | | | | | | |
|---------------------|---------------|------------|----------------|----------------|--------------------------------------|------------------------------|
| D. W. Townsend..... | Cherokee..... | Loess..... | Stiff mud | Iron clad..... | 1 down draft, 3 clamp, 1 continuous. | Common brick and drain tile. |
|---------------------|---------------|------------|----------------|----------------|--------------------------------------|------------------------------|

DIRECTORY OF IOWA CLAY WORKERS—CONTINUED.

CLAY COUNTY.

| FIRM NAME. | LOCATION OF PLANT. | MATERIAL USED. | PROCESS. | DRYER. | KILNS. | PRODUCTS. |
|--------------------------|--------------------|----------------|--------------|--------|---------------------------|---------------|
| Hilliard & Johnson | Spencer..... | Wisconsin .. | Soft mud.... | | 1 up draft 3 down draft.. | Common brick. |

CLARKE COUNTY.

| | | | | | | |
|------------------|--------------|-------------|---------------|-------------|---------------|---------------|
| Geo. Siegel..... | Osceola..... | Loess | Stiff mud.... | Sheds | 2 clamp. | Common brick. |
|------------------|--------------|-------------|---------------|-------------|---------------|---------------|

CLAYTON COUNTY.

| | | | | | | |
|------------------------|------------------|-----------------------------|---------------|-------------|-----------------------------|------------------------------|
| Myron Mellen | Edgewood..... | Loess and Maquoketa shales. | Stiff mud.... | | 1 down draft..... | Common brick and drain tile. |
| Matthias Burr..... | Guttenberg | Loess | Soft mud. .. | | Clamp. | Common brick. |
| Monona Brick Works.... | Monona..... | Loess | Soft mud.... | Sheds | 2 up drafts. 2 down draft.. | Common brick. |

CLINTON COUNTY.

| | | | | | | |
|--------------------------------|-----------------------|-------------|---------------|-------|-------------------|------------------------------|
| Chas. F. Capion..... | Spring Valley Twp.... | Loess | Soft mud.... | | 2 clamp | Common brick. |
| James Taller..... | Clinton..... | Loess | Soft mud.... | | 3 clamp..... | Common brick. |
| W. E. McKinney & Company. | DeWitt..... | Loess | Stiff mud.... | | 2 down draft..... | Common brick and drain tile. |

CRAWFORD COUNTY.

| | | | | | | |
|--------------------|---------------|----------------|---------------|-------|-------------------------|---------------|
| C. Green..... | Denison | Loess. | Stiff mud.... | | 2 clamp, 1 down draft.. | Common brick. |
| Joe La Turno | Manilla..... | Loess | Soft mud.... | | 2 up draft.. | Common brick. |

DALLAS COUNTY.

| | | | | | | |
|---|----------------|----------------------|------------------------------|-------------------------|----------------------------------|-------------------------------------|
| E. O. Fenn..... | Adel | Loess..... | Soft mud..... | | 1 up draft..... | Common brick. |
| S. J. Harris & Company..... | Adel | Loess and shale..... | Stiff mud..... | Hot floor and shed..... | 1 up draft and 3 down draft..... | Common brick and tile. |
| Union Brick and Tile Company..... | Dawson..... | | Stiff mud..... | | 1 Eudaly, 1 Stewart..... | Common brick and drain tile. |
| McKissick and Kiles..... | De Soto..... | Shale..... | Stiff mud..... | | 6 down draft..... | Drain tile. |
| McFarland & Hill..... | Minburn..... | Surface..... | Stiff mud..... | | 2 down draft..... | Brick and tile. |
| Rob't Goodwin, Jr..... | Redfield..... | Shales..... | Stiff mud..... | | 7 down draft..... | Common brick and tile. |
| Platt Pressed & Fire Brick Company..... | Van Meter..... | Shales..... | Dry press and stiff mud..... | Steam..... | 7 down draft..... | Front brick, common brick and tile. |
| Perry Brick and Tile Company..... | Perry..... | Drift..... | Stiff mud..... | | 3 down draft..... | Common brick and tile. |

DAVIS COUNTY.

| | | | | | | |
|----------------------|------------|------------|---------------|-------|-------------------------|---------------|
| M. L. Parker..... | Eldon..... | Loess..... | Soft mud..... | | 1 clamp..... | Common brick. |
| A. P. Birchmier..... | Troy..... | Loess..... | Soft mud..... | | 1 round down draft..... | Common brick. |

DECATUR COUNTY.

| | | | | | | |
|---------------------|-------------------|------------|-------------------------|-------|-------------------|------------------------|
| G. C. Dilsaner..... | Garden Grove..... | Loess..... | Soft and stiff mud..... | | 2 down draft..... | Common brick and tile. |
| W. H. Jenkins..... | Leon..... | Loess..... | Soft mud..... | | 2 up draft..... | Common brick. |

DELAWARE COUNTY.

| | | | | | | |
|----------------------|-----------------|------------|----------------|-------|-------------------------|------------------------|
| Frank H. Stead..... | Hopkinton..... | Drift..... | Stiff mud..... | | 2 round down draft..... | Common and face brick. |
| Chas. H. Mattox..... | Manchester..... | Drift..... | Soft mud..... | | Scove..... | Common brick. |

DES MOINES COUNTY.

| | | | | | | |
|--------------------------------------|-----------------|------------------------|----------------|----------------|-------------------------|--|
| Burlington Pottery Company..... | Burlington..... | Kinderhook shales..... | | | 1 down draft..... | Stoneware. |
| The Granite Brick Company..... | Cascade..... | Kinderhook shales..... | Stiff mud..... | Hot floor..... | 5 Eudaly..... | Paving and common brick and front brick. |
| Mediopolis Tile and Brick Works..... | Mediopolis..... | Loess..... | Stiff mud..... | | 3 round down draft..... | Common brick. |

DIRECTORY OF IOWA CLAY WORKERS—CONTINUED.
DUBUQUE COUNTY.

| FIRM NAME. | LOCATION OF PLANT. | MATERIAL USED. | PROCESS. | DRYER. | KILNS. | PRODUCTS. |
|----------------------|--------------------|----------------|---------------|--------|-----------------|---------------|
| Dietrich Bros | Dubuque | Loess | Soft mud..... | | 8 up draft..... | Common brick. |
| Albert Gasser | Dubuque..... | Loess | Soft mud..... | | Clamp..... | Common brick. |
| Agatha Heim | Dubuque..... | Loess | Soft mud..... | | 8 clamp..... | Common brick. |
| Augustus Klaas | Dubuque..... | Loess | Soft mud..... | | 8 scove..... | Common brick. |

EMMET COUNTY.

| | | | | | | |
|----------------------------------|-----------------|------------------|---------------|------------|-----------------|-------------|
| Armstrong Brick and Tile Company | Armstrong | Wisconsin drift. | Stiff mud.... | Steam..... | Down draft..... | Drain tile. |
|----------------------------------|-----------------|------------------|---------------|------------|-----------------|-------------|

FAYETTE COUNTY.

| | | | | | | |
|-----------------------|---------------|-------------------|---------------|-----------|---------------------------|--------------------------------------|
| C. Miller & Son | Clermont..... | Maquoketa shales. | Stiff mud.... | Shed..... | 4 down draft, 1 up draft. | Common brick, tile and hollow block. |
| L. A. Book | Hawkeve..... | Surface..... | Soft mud..... | | 1 clamp..... | Common brick. |

FLOYD COUNTY.

| | | | | | | |
|--------------------|---------------|------------------|----------------|-------|--------------------------|------------------------|
| L. M. Harris | Rockford..... | Devonian shales. | Stiff mud..... | | 2 scove, 2 down draft... | Common brick and tile. |
|--------------------|---------------|------------------|----------------|-------|--------------------------|------------------------|

FRANKLIN COUNTY.

| | | | | | | |
|-----------------|----------------|------------------|---------------|-------|-------------------|------------------------|
| E. P. Fox | Sheffield..... | Devonian shales. | Stiff mud.... | | 1 down draft..... | Common brick and tile. |
|-----------------|----------------|------------------|---------------|-------|-------------------|------------------------|

FREMONT COUNTY.

| | | | | | | |
|-----------------------------|---------------|-------------|----------------|------------|-----------------|---------------|
| C. W. Carman | Hamburg..... | Loess | Soft mud..... | Sheds..... | Up draft..... | Common brick. |
| Fred Johnson | Hamburg..... | Loess | Soft mud..... | | Up draft..... | Common brick. |
| Johnson Bros | Riverton..... | Loess | Soft mud..... | | 2 up draft..... | Common brick. |
| New South Brick Works | Sidney..... | Loess | Stiff mud..... | | 1 up draft..... | Common brick. |
| John Weatherhead..... | Tabor..... | Loess | Stiff mud..... | | 8 up draft..... | Common brick. |

GREENE COUNTY.

| | | | | | | |
|---------------------------------|---------------------|----------------------|--------------|-------|-------------------|------------------------|
| Goodwin Tile and Brick Company. | Grand Junction..... | Coal measure shales. | Stiff mud .. | | 5 down draft..... | Common brick and tile. |
|---------------------------------|---------------------|----------------------|--------------|-------|-------------------|------------------------|

GRUNDY COUNTY.

| | | | | | | |
|----------------------|--------------------|---------------|-----------------|-------|--------------------------|------------------------|
| C. E. Smith | Grundy Center..... | Surface | Stiff mud | | 2 down draft. | Common brick. |
| Ady & Frerichs | Grundy Center..... | Surface | Stiff mud | | 1 down draft, 1 up draft | Common brick and tile. |

GUTHRIE COUNTY.

| | | | | | | |
|--------------------------|--------------|---------------|-----------------|-------------|--------------------------|------------------------|
| John Piner..... | Stuart..... | Surface | Stiff mud | | 1 down draft, 1 up draft | Common brick and tile. |
| H. M. Pentecost | Panora..... | Coal measures | Stiff mud | Steam | 4 down draft. | Common brick and tile. |
| W. D. Simons & Sons..... | Jamaica..... | Surface | Soft mud..... | | 2 round down draft..... | Common brick and tile. |

HAMILTON COUNTY.

| | | | | | | |
|------------------------------------|--------------------|----------------------|-----------------|-----------------|-------------------|------------------------|
| Jewell Brick and Tile Company..... | Jewell Junction .. | Drift | Stiff mud | Pallet | 1 down draft..... | Common brick and tile. |
| Webster City Brick and Tile Co.... | Webster City..... | Coal measure shales. | Stiff mud | Iron clad. | Down draft..... | Common brick and tile. |

HANCOCK COUNTY.

| | | | | | | |
|---|------------|------------------|--------------|-------|--------------------|------------------------|
| Interstate Drainage and Investment Company. | Britt..... | Wisconsin drift. | Stiff mud .. | | 2 down draft. | Common brick and tile. |
|---|------------|------------------|--------------|-------|--------------------|------------------------|

HARDIN COUNTY.

| | | | | | | |
|----------------------------------|-----------------|---------------------|-----------------|------------------|--------------------|---------------------------------------|
| Eldora Pipe and Tile Co..... | Eldora..... | Shales..... | Stiff mud | Slat floor. | 5 down draft. | Drain tile. |
| Eldora Tile Works..... | Eldora..... | Surface and shales. | Stiff mud | Sheds. | 3 down draft..... | Drain tile. |
| X. Y. Z. Brick and Tile Co | Eldora..... | Shales | Stiff mud | | 2 down draft..... | Drain tile. |
| Gearhart & Mason..... | Gifford | Shales | Stiff mud | | 2 down draft..... | Common brick and tile. |
| F. W. Heidenreich..... | Iowa Falls..... | Shales..... | Stiff mud | | Down draft..... | Common and face brick and drain tile. |

DIRECTORY OF IOWA CLAY WORKERS—CONTINUED.

HARRISON COUNTY.

| FIRM NAME. | LOCATION OF PLANT. | MATERIAL USED. | PROCESS. | DRYER. | KILNS. | PRODUCTS. |
|-------------------------|-----------------------------|----------------|---------------|--------|-----------------|---------------|
| H. L. Wood..... | Dunlap | Loess | Soft mud..... | | 4 up draft..... | Common brick. |
| J. W. Lawson..... | Dunlap..... | Loess..... | Soft mud..... | | Up draft..... | Common brick. |
| J. S. Vanseoy | Woodbine and Logan. | Loess..... | Soft mud..... | | Clamp | Common brick. |
| Elisha Mahoney..... | Near Magnolia R. R. o. 2 | Loess..... | Soft mud..... | | Up draft | Common brick. |
| Chas. Smith..... | Missouri Valley..... | Loess..... | Soft mud..... | | Up draft | Common brick. |
| M. Analyser | Persia | Loess..... | Soft mud..... | | Up draft..... | Common brick. |
| Canfield & Cromie | Woodbine | Loess..... | Soft mud..... | | 3 up draft..... | Common brick. |

HENRY COUNTY.

| | | | | | | |
|----------------------------------|--------------------------------------|------------|----------------|-------------|-------------------|---------------------------------|
| August Brink..... | 2½ miles south of New London..... | Loess..... | Stiff mud..... | | 1 up draft..... | Common brick and drain tile. |
| New London Brick and Tile Co.... | New London..... | Loess..... | Stiff mud..... | Am. Blower. | Stewart..... | Common brick and tile. |
| L. B. Pierce..... | Winfield..... | Loess..... | Stiff mud..... | | 3 down draft..... | Common brick and tile. |
| Jas. Brown..... | Mount Pleasant..... | Loess..... | Soft mud..... | | Clamp | Common brick. |

HOWARD COUNTY.

| | | | | | | |
|-------------------------|-------------|---------------|----------------|------------|-------------------|--|
| Wheeler & Marshall..... | Cresco..... | Iowan Drift.. | Stiff mud..... | S eds..... | 3 down draft..... | Common brick, drain tile and hollow block. |
|-------------------------|-------------|---------------|----------------|------------|-------------------|--|

HUMBOLDT COUNTY.

| | | | | | | |
|----------------------------------|----------------|---------------|----------------|-------|-------------------|--------------------------|
| Livermore Brick and Tile Company | Livermore..... | Wisconsin.... | Stiff mud..... | | 2 down draft..... | Drain tile and brick. |
|----------------------------------|----------------|---------------|----------------|-------|-------------------|--------------------------|

IDA COUNTY.

| | | | | | | |
|-----------------|----------------|---------------|---------------|-------|------------------------------|---------------|
| A. S. Wert..... | Ida Grove..... | Surface | Soft mud..... | | 1 down draft. 3 up draft. | Common brick. |
|-----------------|----------------|---------------|---------------|-------|------------------------------|---------------|

IOWA COUNTY.

| | | | | | | |
|------------------------------------|--------------------------------|--------------|----------------|------------|-------------------|------------------------|
| Dauskin & Wagner..... | 2½ miles southwest of Marengo. | Surface..... | Stiff mud..... | | Down draft..... | Common brick. |
| H. A. Cheney..... | Millersburg..... | Loess..... | Soft mud..... | Shed..... | 1 down draft..... | Common brick. |
| E. J. Smith & Sons..... | North English..... | Loess..... | Stiff mud..... | | 4 down draft..... | Common brick and tile. |
| Williamsburg Brick and Tile Co.... | Williamsburg..... | Loess..... | Stiff mud..... | Steam..... | 3 down draft..... | Common brick and tile. |
| Preston Tile Works..... | Preston..... | Loess..... | Stiff mud..... | | 1 down draft..... | Drain tile. |

JASPER COUNTY.

| | | | | | | |
|--------------------------|-----------------------|------------|----------------|-----------|--------------------------|------------------------------|
| Henry Harrington..... | Colfax..... | Loess..... | Soft mud..... | | 3 up draft..... | Common brick. |
| Holdsworth Brothers..... | Kellogg..... | Loess..... | Stiff mud..... | | | Brick and tile. |
| Newby & Macy..... | Lynnville..... | Loess..... | Stiff mud..... | Shed..... | 1 down draft, 1 Stewart. | Common brick and tile. |
| G. H. Orcutt..... | Monroe..... | Loess..... | Stiff mud..... | | 3 down draft..... | Common brick and drain tile. |
| William Henning..... | ¼ mile west of Newton | Loess..... | | | 2 up draft, 2 Cooke..... | Common brick. |

JEFFERSON COUNTY.

| | | | | | | |
|------------------------------------|----------------|-------------------|----------------|-------|-------------------|------------------------|
| Batavia Brick and Tile Company.... | Batavia..... | Loess..... | Stiff mud..... | | 1 down draft..... | Brick and tile. |
| Raney Brothers..... | Fairfield..... | Loess and shales. | Stiff mud..... | | Down draft..... | Common brick and tile. |
| W. E. Supernois..... | Packwood..... | Loess..... | Stiff mud..... | | 2 down draft..... | Drain tile. |

JOHNSON COUNTY.

| | | | | | | |
|------------------------------|---------------------|------------|----------------|-------------------|---------------------------|--|
| Frendale Brick and Tile..... | Frendale..... | Loess..... | Stiff mud..... | Pallet and sheds. | 1 down draft, 1 up draft. | Common brick and drain tile. |
| Christ Gauchoer..... | Iowa City..... | Loess..... | Soft mud..... | | 3 clamp kilns..... | Common brick. |
| Michael Goss..... | Iowa City..... | Loess..... | Soft mud..... | | 2 clamp kilns..... | Common and front brick. |
| Oakes Brothers..... | Iowa City..... | Loess..... | Stiff mud..... | | 3 down draft..... | Common brick and drain tile. |
| P. H. Katzemeyer..... | River Junction..... | Loess..... | Soft mud..... | | 1 up draft..... | Common and front brick. |
| Tiffin Tile Company..... | Tiffin..... | Loess..... | Stiff mud..... | | 2 Stewart..... | Common brick, drain tile and hollow block. |

JONES COUNTY.

| | | | | | | |
|------------------|--------------|------------|---------------|-------|------------|---------------|
| B. F. Smith..... | Anamosa..... | Loess..... | Soft mud..... | | Scove..... | Common brick. |
|------------------|--------------|------------|---------------|-------|------------|---------------|

DIRECTORY OF IOWA CLAY WORKERS—CONTINUED.
KEOKUK COUNTY.

| FIRM NAME. | LOCATION OF PLANT. | MATERIAL USED. | PROCESS. | DRYER. | KILNS. | PRODUCTS. |
|----------------------------|---------------------|----------------|---------------|--------------------|---------------------------------|------------------------------|
| F. W. Heidenreich | Hedrick | Loess | Stiff mud ... | Steam heated shed. | Down draft | Drain tile. |
| S. K. Leacox | Keota | Loess | Stiff mud ... | | Down draft: 2 round, 1 Stewart. | Common brick and drain tile. |
| U. R. Harvey & Son | Martinsburg | Loess | Stiff mud ... | Sheds | 2 down draft. | Common brick and drain tile. |
| Jas. L. Hill | Sigourney | Loess | Stiff mud ... | | Down draft: 1 round, 1 square. | Common brick and drain tile. |
| Lawler Brothers & Co. | South English | Loess | Stiff mud ... | | 2 down draft. | Common brick and drain tile. |
| G. G. Nicholson | What Cheer | Loess | Stiff mud ... | Sheds | 2 down draft. | Common brick and drain tile. |

KOSSUTH COUNTY.

| | | | | | | |
|--------------------|--------------|------------------|---------------|-------------|------------------|---------------|
| A. P. Ostrum | Algona | Wisconsin drift. | Stiff mud ... | Sheds. | 2 up draft. | Common brick. |
|--------------------|--------------|------------------|---------------|-------------|------------------|---------------|

LEE COUNTY.

| | | | | | | |
|----------------------------------|------------------------------------|-------------|-----------------|-------|--------------------|---|
| J. B. Helling & Son | Fort Madison | Loess | Stiff mud. | | 1 up draft | Common brick. |
| Ben Kotzenstette & Company | $\frac{1}{2}$ mi. out Fort Madison | Loess | Soft mud. | | 1 down draft. | Common brick. |
| Gate City Brick Works | Keokuk | Loess | Soft mud. | | Scove | Common brick. |
| Julius Reichelt | Fort Madison | Loess | Stiff mud. | | 1 down draft. | Common brick, front brick and drain tile. |
| McCutcheon & Swanson | Keokuk | Loess | Stiff mud. | | 1 down draft. | Common brick and front brick. |

LINN COUNTY.

| | | | | | | |
|-------------------------------------|--------------------|-------------|-----------------|---------------|----------------------------------|------------------------------|
| Chas. L. Besler | Cedar Rapids | Loess | Soft mud. | Standard. ... | Clamp kiln. | Common brick. |
| G. W. McBride | Cedar Rapids | Loess | Soft mud. | | 2 up draft. | Common brick. |
| D. W. Stooky | Cedar Rapids | Loess | Stiff mud. | | 2 down draft. | Drain tile. |
| P. A. Wolf | Cedar Rapids | Loess | Soft mud. | | 4 up draft. | Common brick. |
| C. W. Johnson | Center Point | Loess | Stiff mud. | | 1 up and down draft and 1 clamp. | Common brick and drain tile. |
| Central City Brick and Tile Co. ... | Central City | Loess | Stiff mud. | | 2 down draft. | Common brick and drain tile. |
| McBride & Snyder | Marion | Loess | Stiff mud. | | 1 up draft. | Common brick and drain tile. |
| H. E. Mason | Mt. Vernon | Loess | Soft mud. | | 1 open kiln. | Common brick. |

LOUISA COUNTY.

| | | | | | | |
|----------------------------------|----------------------|------------|----------------|-------|----------------|------------------------------|
| G. W. Oakes..... | Columbus Junction... | Loess..... | Stiff mud... | | | Common brick and drain tile. |
| McClurkin, Ochiltree & Company.. | Morning Sun..... | Loess..... | Stiff mud..... | | 1 Stewart..... | Common brick and drain tile. |

LUCAS COUNTY.

| | | | | | | |
|----------------|---------------|------------|---------------|-------|-------------|---------------|
| S. Bailey..... | Chariton..... | Loess..... | Soft mud..... | | 2 open..... | Common brick. |
|----------------|---------------|------------|---------------|-------|-------------|---------------|

MADISON COUNTY.

| | | | | | | |
|-----------------|----------------|------------|---------------------|-------|-------------------|------------------------------|
| Clark Bros..... | Winterset..... | Loess..... | Soft and stiff mud. | | 2 down draft..... | Common brick and drain tile. |
|-----------------|----------------|------------|---------------------|-------|-------------------|------------------------------|

MAHASKA COUNTY.

| | | | | | | |
|----------------------------------|------------------|-------------|----------------|--------------------|--------------------------|--|
| Ollie Wilson..... | Barnes City..... | Loess..... | Stiff mud... | Sheds..... | 2 down draft..... | Common brick and drain tile. |
| John Dawson & Co..... | Fremont..... | Loess..... | Stiff mud..... | | 2 square down draft..... | Common brick and drain tile. |
| Chas. Stark..... | Muscatine..... | | | | | Clay pipes, common brick. |
| Martin & Younkin..... | New Sharon..... | Loess..... | Stiff mud..... | Steam..... | 3 down draft..... | Drain tile, hollow block |
| Peter Meyer..... | New Sharon..... | Loess..... | Stiff mud..... | | | Drain tile, common brick. |
| M. N. Logue..... | Oskaloosa..... | Loess..... | Soft mud..... | | 3 clamp..... | Common brick. |
| Oskaloosa Paving Brick Company.. | Oskaloosa..... | Shales..... | Stiff mud..... | Standard dry kiln. | | Common brick, front brick, paving brick. |

MARION COUNTY.

| | | | | | | |
|-------------------------------|----------------|------------|----------------|-------|-------------------|------------------------------|
| King Bros..... | Knoxville..... | Loess..... | Stiff mud..... | | 1 down draft..... | Common brick and drain tile. |
| Dillon Wright..... | Knoxville..... | | | | | |
| Otis J. Penton..... | Otterbein..... | Loess..... | Stiff mud..... | | 1 clamp..... | Common brick and drain tile. |
| Pella Drain Tile Company..... | Pella..... | Loess..... | Stiff mud..... | | 5 down draft..... | Common brick and drain tile. |

DIRECTORY OF IOWA CLAY WORKERS—CONTINUED.

MARSHALL COUNTY

| FIRM NAME. | LOCATION OF PLANT. | MATERIAL USED. | PROCESS. | DRYER. | KILNS. | PRODUCTS. |
|-----------------------------------|--------------------|----------------|---------------------|------------------|---------------------------|------------------------------|
| Bromley Brick and Tile Works..... | Bromley..... | Loess..... | Stiff mud .. | | 3 down draft..... | Drain tile. |
| W. H. Vosburg & Co..... | Gilman..... | Loess..... | Stiff mud..... | | 1 up draft, 1 down draft. | Common brick and drain tile. |
| Liscomb Brick and Tile Company .. | Liscomb..... | Loess..... | Stiff mud..... | | 5 down draft..... | Drain tile. |
| Anson Company..... | Marshalltown..... | Loess..... | Dry press..... | | 3 up draft..... | Common brick. |
| Buchwald & Cummings..... | Marshalltown..... | Loess..... | Stiff mud..... | | 2 down draft clamp..... | Common brick and drain tile. |
| Size & Carpenter..... | Marshalltown..... | Loess..... | Soft and stiff mud. | Rack and pallet. | 6 up draft..... | Common brick. |
| Marshalltown Pottery Company.... | Marshalltown..... | | | | 4 down draft..... | Stoneware. |
| Melbourne Brick and Tile Company | Melbourne..... | Loess..... | Stiff mud..... | | 1 down draft, 2 Stewart | Common brick and drain tile. |
| A. J. Bonham..... | Rhodes..... | Loess..... | Stiff mud..... | | 2 down draft..... | Common brick and drain tile. |

MILLS COUNTY.

| | | | | | | |
|--|-----------------------|------------|----------------|------------|-----------------|---------------|
| J. W. McMullin..... | Emerson..... | Loess..... | Soft mud..... | | Open..... | Common brick. |
| Iowa Institution for Feeble-Minded Children. | On State Grounds..... | Loess..... | Soft mud..... | | 2 up draft..... | Common brick. |
| E. A. Stone & Son..... | Malvern..... | Loess..... | Stiff mud..... | Sheds..... | 2 up draft..... | Common brick. |

MONONA COUNTY.

| | | | | | | |
|-----------------|---------------|------------|---------------|-------|----------------|---------------|
| Ira C. Ray..... | Moorhead..... | Loess..... | Soft mud..... | | Temporary..... | Common brick. |
|-----------------|---------------|------------|---------------|-------|----------------|---------------|

MONROE COUNTY.

| | | | | | | |
|---------------------------------|----------------|------------|-------|-------|-------|--------------------|
| Davy Burnt Clay Ballast Company | Selection..... | Loess..... | | | | Burnt clay ballast |
|---------------------------------|----------------|------------|-------|-------|-------|--------------------|

MONTGOMERY COUNTY.

| | | | | | | |
|---------------------------------|----------|------------------|-------------------------|---------|---------------------------|--------------------------------|
| H. F. Lenneke | Elliott | Loess | Soft mud | | 2 clamp. | Common brick. |
| R. E. Cook | Red Oak | Loess | Stiff mud | | 1 down draft, 3 up draft. | Common brick and drain tile. |
| J. C. Curtis | Red Oak | Loess and shale. | Stiff mud, dry press. | | 2 down draft, 2 up draft. | Common, front and fire brick. |
| Villisca Brick and Tile Company | Villisca | Loess | Stiff mud | Bucyrus | 3 up draft, 1 down draft. | Common brick and drain tile. |
| Weatherhead & Giveuspiel | Red Oak | Loess | Soft mud and dry press. | | 2 up draft. | Common, pressed brick. |
| J. C. Curtis | Red Oak | Shale | | | 2 up and 2 down draft. | Red earthenware and stoneware. |

MUSCATINE COUNTY.

| | | | | | | |
|---------------------------------|-----------|------------------|-----------|--|----------------------------|------------------------------|
| Jno. Schellhorn | Fairport | | | | 1 muffle. | Red earthenware. |
| G. E. Feustel | Fairport | | | | 1 semi-muffle, 1 up draft. | Red earthenware. |
| J. Koetting & Sons | Muscatine | Loess | Soft mud | | 2 up draft. | Common brick. |
| Carl Hagemeister | Muscatine | Loess | Soft mud | | 3 up draft. | Common brick. |
| Muscatine Pressed Brick Company | Muscatine | Loess | Soft mud | | 4 clamp. | Common brick. |
| Nyenhuis Brothers | Muscatine | Loess | Soft mud | | Clamp. | Common brick. |
| Samuel Brothers | Muscatine | Loess | Soft mud | | 3 square up draft. | Common brick. |
| Fred Beenk | Wheatland | Loess | Stiff mud | | 1 down draft. | Common brick and drain tile. |
| O'Brien Sheldon Brick Company | Sheldon | Wisconsin drift. | Soft mud | | 2 down draft. | Common brick. |

PAGE COUNTY.

| | | | | | | |
|-------------------|------------|-------|-----------|------------------|---------------|---------------|
| J. M. Crabill | Clarinda | Loess | Soft mud | Back and pallet. | | Common brick. |
| F. A. Cook & Sons | Clarinda | Loess | Stiff mud | | 2 down draft. | Drain tile. |
| Rankin Brothers | Shenandoah | Loess | Stiff mud | | 6 up draft. | Common brick |

PLYMOUTH COUNTY.

| | | | | | | |
|-----------------|---------|-------|----------|--|-------------|---------------|
| John A. Leonard | Le Mars | Loess | Soft mud | | 2 up draft. | Common brick. |
|-----------------|---------|-------|----------|--|-------------|---------------|

POCAHONTAS COUNTY.

| | | | | | | |
|-----------------|-------|------------------|-----------|--|---------------|-------------|
| Straight Bros. | Fonda | Wisconsin drift. | Stiff mud | | 5 down draft. | Drain tile. |
| Nelson & Dawson | Rolfe | Wisconsin drift. | Stiff mud | | 2 down draft. | Drain tile. |

DIRECTORY OF IOWA CLAY WORKERS—CONTINUED.
POLK COUNTY.

| FIRM NAME. | LOCATION OF PLANT. | MATERIAL USED. | PROCESS. | DRYER. | KILNS. | PRODUCTS. |
|-----------------------------------|--------------------|--------------------|-----------------------|-------------|--|--|
| Des Moines Co-operative Brick Co. | Des Moines | Modified loess | Soft mud | | 2 up draft, 1 down draft, 1 clamp. | Common brick. |
| Bridge Bros. | Bondurant | Surface | Stiff mud | | 1 clamp, 1 Stewart. | Drain tile. |
| W. H. Brereton | Des Moines | Modified loess | | | | Common brick. |
| Barber Asphalt Paving Company | Des Moines | Shales | Stiff mud | Direct heat | 5 round, 1 long, 1 continuous. | Common brick and paving brick. |
| Dale Brick Company | Des Moines | Shale and loess. | Dry press, stiff mud. | Wolf | 4 clamp, 4 down draft. | Common brick, front brick and hollow block. |
| Flint Brick Company | Des Moines | Shale | Stiff mud | | 6 Eudaly. | Common brick, front brick and paving brick. |
| J. T. Fredregill | Des Moines | Modified loess | Soft mud | Sheds | 2 down draft. | Common brick. |
| Iowa Brick Manufacturing Co. | Des Moines | Shale | Stiff mud | Standard | 7 square, 1 round down draft. | Common brick, paving brick and hollow block. |
| Iowa Pipe and Tile Company | Des Moines | Shale | Stiff mud | Stat floor | | Drain tile and sewer tile. |
| Likes Improvement Company | Des Moines | Shale | Stiff mud | | 8 down draft. | Common and paving brick. |
| James Maine | Des Moines | Modified loess | Soft mud | | 4 down draft, 2 clamp. | Common brick. |
| Pixley Conduit Company | Des Moines | Shale | Stiff mud | | 5 down draft. | Hollow block and electrical conduits. |
| Shackelford Brick Company | Des Moines | Surface and shale. | Stiff mud | Freese | 4 down draft, 4 clamp. | Common brick. |
| Star Brick Company | Des Moines | Surface | Soft mud | | 3 up draft. | Common brick. |
| Granite Brick Company | Hastie | Shale | Dry press, stiff mud. | | 3 down down draft, 2 up draft, 1 continuous. | Common brick and front brick. |
| E. Woodworth | Mitchellville | Loess | Stiff mud | | 2 up draft, 1 down draft. | Common brick. |
| Hug & Harman | Polk City | Surface | Stiff mud | | 2 down draft. | Drain tile. |
| Des Moines B. & T. Company | Des Moines | Shale | Stiff mud | Tunnel | Round down draft. | Drain tile. |
| Goodwin Tile and Brick Company | Des Moines | Shale | Stiff mud | | 5 down draft. | Drain tile. |

POTTAWATTAMIE COUNTY.

| | | | | | | |
|-----------------------------|---------------------|-------------|---------------------|--------------|----------------------------|-----------------------------|
| Avoca Pressed Brick Co..... | Avoca | Loess | Soft mud..... | | Down draft | Common brick. |
| Karl Anderson..... | Council Bluffs..... | Loess..... | Soft mud..... | | 2 clamp..... | Common brick. |
| L. C. Besley..... | Council Bluffs..... | Loess..... | Stiff and soft mud. | Pallet | 2 up draft, 3 down draft.. | Common brick. |
| John P. Weaver..... | Council Bluffs..... | Loess..... | Soft and stiff mud. | | 4 up draft, 1 down draft. | Common brick, paving brick. |
| Wickham Bros..... | Council Bluffs..... | Loess..... | Soft mud..... | | 4 up draft..... | Common brick. |
| C. C. Norgaard | Council Bluffs..... | Loess..... | Soft mud..... | | Clamp..... | Common brick. |
| Willoughby, Dye & Co..... | Meceдонia..... | Loess..... | Stiff mud..... | | 4 clamp..... | Common brick, drain tile |

POWESHIEK COUNTY.

| | | | | | | |
|-----------------------|-----------------|------------|----------------|-------|-------------------|---|
| McHose Bros..... | Grinnell..... | Loess..... | Stiff mud..... | | 3 down draft..... | Common brick, drain tile, hollow block. |
| B. J. Broadston | Montezuma | Loess..... | Stiff mud..... | | Down draft..... | Common brick, drain tile. |

RINGGOLD COUNTY.

| | | | | | | |
|---------------------------------|-----------------|------------|----------------|-------------|---------------------------|---------------|
| Diagonal Brick and Tile Co..... | Diagonal | Loess..... | Stiff mud..... | Shed..... | 2 up draft..... | Common brick. |
| Kellerton Brick and Tile | Kellerton | Loess..... | Stiff mud..... | Sheds | 1 up draft, 2 down draft. | Common brick. |

SAC COUNTY.

| | | | | | | |
|---------------------|-----------------|------------|---------------|-------|---------------|---------------|
| George Hicks | Grant City..... | Loess..... | Soft mud..... | | Open | Common brick. |
| Wm. Pellersels..... | Sac City..... | Loess..... | Soft mud..... | | Up draft..... | Common brick |

SCOTT COUNTY.

| | | | | | | |
|--|-----------------|------------|----------------|-------|-------------------|---|
| Bettendorf Brick and Tile Co | Bettendorf..... | Loess..... | Soft mud..... | | 2 open..... | Common brick. |
| Davenport Paving Brick and Tile Co | Buffalo | Shale..... | Stiff mud..... | | 8 down draft..... | Paving brick, drain tile, hollow block. |
| Black Hawk Brick Co | Davenport | Loess..... | Soft mud..... | | 4 clamp..... | Common brick. |
| Otten & Pohlmann..... | Davenport | Loess..... | Soft mud..... | | 4 clamp..... | Common brick. |
| H. D. Pohlmann's Sons..... | Davenport | Loess..... | Soft mud..... | | | Common brick. |

SHELBY COUNTY.

| | | | | | | |
|------------------------------------|--------------|------------|---------------|-------|----------------|------------------------------|
| Harlan Brick and Tile Company..... | Harlan | Loess..... | Soft mud..... | | 3 clamp..... | Common brick and drain tile. |
| | | | | | 1 Holman | |

DIRECTORY OF IOWA CLAY WORKERS—CONTINUED.

SIoux COUNTY.

| FIRM NAME | LOCATION OF PLANT. | MATERIAL USED | PROCESS. | DRYER. | KILNS. | PRODUCTS. |
|-------------------|--------------------|---------------|--------------|--------|--------------|---------------|
| G. W. Orton | Maurice | Loess | Stiff mud .. | | 4 open | Common brick. |
| A. H. Kuhne | Rock Valley | Loess | Soft mud .. | | Open | Common brick. |

STORY COUNTY.

| | | | | | | |
|--------------------------------------|--------------------|---------------|--------------|-------------|--------------------|--|
| Chas. E. McHose | Maxwell | Shale | Stiff mud .. | | 3 down draft | Common brick, paving brick and drain tile. |
| R. C. Stark | Kelly | Loess | Stiff mud .. | Shed | Down draf | Common brick. |
| S. M. McHose | Nevada | Surface | Stiff mud .. | | | Common brick and drain tile. |
| F. Hennaman | State Center | Loess | Soft mud .. | Sheds | 2 square | Common brick. |
| Cambridge Brick and Tile Works | Cambridge | Loess | Stiff mud .. | | 1 down draft | Common brick and drain tile. |

TAMA COUNTY.

| | | | | | | |
|---------------------------------------|------------------|----------------|--------------|-------|--------------------|----------------------------------|
| Dysart Brick and Tile Company | Dysart | Surface | Stiff mud .. | | 5 down draft | Common brick and drain tile. |
| Gethmann Bros | Gladbrook, | Surface | Dry press .. | | 4 down draft | Common brick and front brick. |
| Gladbrook Dry Pressed Brick Co. | Gladbrook | Surface | Dry press .. | | Down draft | Common and front brick. |
| C. B. Bently & Son | Tama | Loess | Stiff mud .. | | 1 up draft | Common brick. |
| John Wild & Son | Toledo | Modified loess | Stiff mud .. | | 2 open | Common brick and drain tile. |
| | | | | | 1 down draft | |

TAYLOR COUNTY.

| | | | | | | |
|------------------------|----------------|---------------|-------------|-------|------------------|---------------|
| G. S. McKinley | Bedford | Surface | Soft mud .. | | Open | Common brick. |
| Miles E. Watson | Blockton | Surface | Soft mud .. | | 2 up draft | Common brick. |
| W. B. Cunningham | Brooks | Surface | Soft mud .. | | 2 clamp | Common brick. |
| Geo. Lewellen | Gravity | Loess | Soft mud .. | | 2 clamp | Common brick. |

UNION COUNTY.

| | | | | | | |
|---------------------|---------------|-------------|-----------------|-------|--------------------|--|
| D. J. Spencer | Afton | Loess | Stiff mud | | 1 Stewart | Common brick and drain tile. |
| Tramp Brothers..... | Creston | Loess | Stiff mud | | 8 down draft | Common brick, drain tile and hollow block. |

VAN BUREN COUNTY.

| | | | | | | |
|--------------------------|-----------------|---------------|-----------------|--------------|------------------|---------------|
| H. A. Whitmore..... | Bonaparte..... | Surface | Stiff mud | | Open | Common brick. |
| Vansgen Brickyard..... | Farmington..... | Surface | | | Open | Common brick. |
| C. W. Baird | Milton..... | Surface | Soft mud | | 1 up draft..... | Common brick. |
| Hangler & Kirkhart | Milton..... | Surface | Stiff mud | Pallet | Down draft | Common brick. |

WAPELO COUNTY.

| | | | | | | |
|---|-------------------|---------------|-----------------|-------------|-----------------------------|--|
| H. B. Ostdiek | Ottumwa | Surface | Soft mud..... | | 8 Swift. | Common brick and front brick. |
| Ottumwa Brick and Construction Company. | Ottumwa | Shale | Stiff mud..... | Steam | 1 continuous, 5 down draft. | Common brick, paving brick, drain tile and hollow block. |
| Swift & Campbell Brick Company.. | East Ottumwa..... | Surface | Stiff mud | Sheds | 4 up draft, 1 continuous. | Common brick. |

WARREN COUNTY.

| | | | | | | |
|------------------|---------------|-------|-------|-------|----------------|---------------|
| W. G. Kurtz..... | Hartford..... | | | | Up draft | Common brick. |
|------------------|---------------|-------|-------|-------|----------------|---------------|

WASHINGTON COUNTY.

| | | | | | | |
|-------------------|------------------|---------------|-----------------|-------|---|------------------------------|
| H. L. Swift | Riverside | Surface | Stiff mud | | 5 down draft | Common brick and drain tile. |
| Jas. Eckels | Washington | Surface | Stiff mud | | | Drain tile. |
| E. A. Swift | Washington | Surface | Stiff mud | | 3 round, 1 square down draft, 4 up draft. | Common brick and drain tile. |

WAYNE COUNTY.

| | | | | | | |
|---------------------|----------------------|---------------|-----------------|-------------|--------------------|------------------------------|
| A. L. Wigert | Allerton | Surface | Soft mud..... | | 3 up draft | Common brick. |
| Alex Mardis..... | Corydon | Surface | Soft mud | Sheds | 3 clamp | Common brick. |
| Logan & Gann | Lineville | Surface | Soft mud | | | Common brick. |
| Brown Brothers..... | Crawfordsville | Surface | Stiff mud | | 2 down draft | Common brick and drain tile. |

DIRECTORY OF IOWA CLAY WORKERS—CONTINUED.

WEBSTER COUNTY.

| FIRM NAME. | LOCATION OF PLANT. | MATERIAL USED. | PROCESS. | DRYER. | KILNS. | PRODUCTS. |
|--|----------------------|-----------------|----------------|------------------|----------------------------------|---|
| Fort Dodge Stoneware Company | Fort Dodge | Shale | | | 2 up draft, | Stoneware. |
| Bradshaw & Company..... | Fort Dodge..... | Shale..... | Stiff mud..... | | 4 down draft..... | Drain tile, hollow block. |
| Fort Dodge Brick and Tile Company | Fort Dodge..... | Shale..... | Stiff mud..... | Steam..... | 2 square, 4 round down draft. | Common brick and hollow block. |
| Fort Dodge Clay Works..... | Fort Dodge..... | Shale..... | Stiff mud..... | Wolff & Andrews. | 1 continuous and 3 down draft. | Common brick. |
| Kalo Brick and Tile Company..... | Kalo..... | Shale..... | Stiff mud..... | | 7 down draft..... | Common brick, drain tile, hollow block. |
| Johnston Bros..... | Kalo Junction..... | Shale..... | Stiff mud..... | | 5 down draft..... | Common brick, drain tile, hollow block. |
| Corey Pressed Brick Company..... | Lehigh..... | Shale..... | Dry press..... | | 5 down draft, 1 muffle up draft. | Front brick. |
| Lehigh Clay Works..... | Lehigh..... | Shale..... | Stiff mud..... | | 8 down draft..... | Drain tile, hollow block. |
| Jas. Campbell..... | Lehigh..... | Shale..... | Stiff mud..... | | 6 down draft..... | Common brick, drain tile, hollow block. |
| Lehigh Brick and Tile Company.... | Lehigh..... | Shale..... | Stiff mud..... | | 8 down draft..... | Drain tile, hollow block. |

WINNESHIEK COUNTY.

| | | | | | | |
|---------------------|--------------|--------------|---------------|-------|---------------------------|---------------|
| Kornmeyer Bros..... | Decorah..... | Surface..... | Soft mud..... | | 1 down draft, 1 scove.... | Common brick. |
| Henry Schulz..... | Decorah..... | Surface..... | | | | Common brick. |

WOODBURY COUNTY.

| | | | | | | |
|------------------------------------|-----------------------------------|---------------|-----------------|--------------|-----------------------------------|---|
| Cherry Red Pressed Brick Co. | Correctionville | Loess | Dry press | | 2 down draft. | Front brick. |
| Leeds Brick Works | Leeds | Surface | Stiff mud. | | 3 up draft. | Common brick. |
| Lower Brick Company | Riverside, Sioux City. | Shale | Stiff mud. | | 1 Radford, 1 Hoffman, continuous. | Common and front brick. |
| Sioux City Brick and Tile Co. | Springdale, North Riverside | Shale | Stiff mud. | | 1 Haigh, continuous | Common and front brick, drain tile, hollow block. |
| Sioux Paving Brick Company | Riverside, Sioux City. | Shale | Stiff mud. | | | Common brick, hollow block. |
| C. J. Holman & Brother. | Sargents Bluffs | Shale | Stiff mud. | Tunnel. | 12 Ho'man | Common and paving brick, hollow block. |
| C. W. Ritz | Sargents Bluffs | Shale | Stiff mud. | | 1 continuous | Common brick. |

WRIGHT COUNTY.

| | | | | | | |
|---------------------------------|-------------------|---------------|-----------------|-------|--------------------|---------------------------|
| C. A. Quasdorf | Dows | Surface | Stiff mud. | | 4 down draft. | Drain tile. |
| David Morgan | Eagle Grove | Surface | Stiff mud. | | 1 down draft. | Drain tile. |
| John Floyd and Son | Eagle Grove | Surface | Stiff mud. | | 2 down draft. | Common brick, drain tile. |
| Star Brick and Tile Works | Goldfield | Surface | Stiff mud. | | 3 down draft. | Common brick, drain tile. |

ACKNOWLEDGMENTS.

The writers of this report desire to express their appreciation and obligation to the clay workers of the state who have so generously co-operated in the carrying forward of the work. In fact, anything like a satisfactory report would have been impossible without their assistance.

Most of the chemical work was done by Dr. J. B. Weems, Chemist of the Survey, and the chapter entitled "Chemistry of Clays" included in this report, dealing with the methods of rational and ultimate analyses, was prepared by Dr. Weems, and will undoubtedly prove to be a welcome contribution to chemists generally.

The laboratory work on the physical properties of clays was done by Mr. I. A. Williams, and the chapter on technology bearing upon these properties, and the descriptions of clay working machinery and processes were almost wholly prepared by him. Nearly all of the cuts illustrating the various types of clay working machinery were generously loaned by the manufacturers of the most approved types in the country, and to them due acknowledgment is made herewith.

The chapter on "Power Plants" prepared by Professor Bissell is timely and will undoubtedly be appreciated by all progressive clay workers.

It was the intention of the writers to include an elaborate report on clay testing but owing to the press of other work Professor Marston was unable to complete his work on the tests of paving brick. Fairly complete reports are submitted on common brick and dry press brick, and synopses on hollow block and paving brick.

In the preparation of the chapter on "The Geology of Clays" published articles and, in some instances, the unpublished notes of members of the Survey, to which the completeness of this chapter is largely due, were freely used and without special acknowledgment in the text.

The increasing scarcity of good lumber gives any treatise on structural materials, which may be used as substitutes for lumber, greater interest than it would otherwise deserve, and it is hoped that the present volume may be of service to contractors, builders and prospective as well as active clay workers.

MINERAL PRODUCTION OF IOWA

IN 1903

BY

S. W. BEYER.

VALUE OF MINERAL PRODUCTION.

1902.

| | |
|-------------|---------------------|
| Coal..... | \$ 8,058,779 |
| Clay..... | 2,843,591 |
| Stone..... | 673,591 |
| Gypsum..... | 337,735 |
| Lead..... | 11,178 |
| Total..... | <u>\$11,924,644</u> |

1903.

| | |
|-------------|---------------------|
| Coal..... | \$10,439,139 |
| Clay..... | 3,033,583 |
| Stone..... | 597,965 |
| Gypsum..... | 523,008 |
| Lead..... | 3,013 |
| Total..... | <u>\$14,596,708</u> |

MINERAL PRODUCTION IN IOWA FOR 1903.

BY S. W. BEYER.

In the production for 1903, Iowa shows a gain of more than 21 per cent in the selling value of her mineral products marketed. Coal, clay goods and gypsum show substantial increases, while a falling off is recorded in lead and quarry products. No zinc or iron was sold during the year.

The number of producers for the various mineral industries of the state is shown below in parallel columns for the years 1900 to 1903 inclusive.

| | 1900 | 1901 | 1902 | 1903 |
|--------------------|------|------|------|------|
| Coal..... | 231 | 242 | 274 | 271 |
| Clay..... | 381 | 349 | 329 | 296 |
| Stone..... | 170 | 229 | 273 | 197 |
| Gypsum..... | 7 | 7 | 7 | 8 |
| Lead and zinc..... | 6 | 10 | 8 | 8 |
| Iron..... | 1 | 1 | ... | ... |
| | 796 | 838 | 891 | 780 |

The number of producers reporting shows a marked decrease owing to the continued wet weather which made the "summer brickyard" unprofitable and many of the smaller quarries impossible.

The statistics were gathered as usual through the co-operation of the Federal and State Geological Surveys.

The value of the total mineral production in Iowa for 1903 is shown in Table I.

TABLE No. 1.

VALUE OF TOTAL MINERAL PRODUCTION BY COUNTIES FOR 1903.

| COUNTIES. | Number of producers | TOTAL COAL. | TOTAL CLAY. | TOTAL STONE. | MISCELLANEOUS | TOTAL. |
|------------------|---------------------|-------------|-------------|--------------|---------------|-----------|
| Adair..... | 3 | \$..... | \$ 14,360 | \$. | \$..... | \$ 14,360 |
| Adams..... | 23 | 57,700 | 27,230 | .. | | 84,930 |
| Allamakee..... | 4 | | | 479 | | 479 |
| Appanoose..... | 54 | 1,784,682 | | 710 | | 1,785,392 |
| Auburn..... | 1 | | | | | |
| Benton..... | 9 | | 22,015 | 1,165 | | 23,180 |
| Black Hawk..... | 9 | | 10,375 | 15,492 | | 25,867 |
| Boone..... | 14 | 599,040 | 82,968 | | | 682,008 |
| Bremer..... | 2 | | 2,193 | | | 2,193 |
| Buena Vista..... | 3 | | 17,026 | | | 17,026 |
| Buchanan..... | 1 | | | | | |
| Butler..... | 1 | | | | | |
| Calhoun..... | 3 | | 13,745 | | | 13,745 |
| Carroll..... | 1 | | | | | |
| Cass..... | 2 | | 10,596 | | | 10,596 |
| Cedar..... | 4 | | | 59,782 | | 59,782 |
| Cerro Gordo..... | 8 | | 258,415 | 34,145 | | 292,560 |
| Cherokee..... | 1 | | | | | |
| Clarke..... | 5 | | | 882 | | 882 |
| Clay..... | 1 | | | | | |
| Clayton..... | 9 | | 13,622 | 14,888 | | 28,510 |
| Clinton..... | 12 | | 10,200 | 4,570 | | 14,770 |

VALUE OF TOTAL MINERAL PRODUCTION.

649

TABLE No. I--CONTINUED.

| COUNTIES. | Number of producers. | TOTAL COAL | TOTAL CLAY | TOTAL STONE. | MISCELLANEOUS | TOTAL. |
|-----------------------|----------------------|--------------|--------------|--------------|---------------|---------------|
| Crawford..... | 2 | \$ | \$ 11,500 | \$ | \$ | \$ 11,500 |
| Dallas..... | 21 | 86,424 | 96,625 | 20,126 | | 153,175 |
| Davis..... | 3 | | 510 | | | 510 |
| Decatur..... | 6 | | 4,750 | 8,769 | | 13,519 |
| Delaware..... | 4 | | 7,900 | 5,240 | | 12,540 |
| Des Moines..... | 11 | | 27,020 | 7,877 | | 34,897 |
| Dubuque..... | 15 | | 35,595 | 54,951 | 3,013 | 93,559 |
| Fayette..... | 7 | | 15,900 | 7,375 | | 23,275 |
| Floyd..... | 5 | | | 5,050 | | 5,050 |
| Fremont..... | 5 | | 9,750 | | | 9,750 |
| Franklin..... | 1 | | | | | |
| Greene..... | 10 | 57,580 | | | | 57,580 |
| Grundy..... | 3 | | 1,742 | | | 1,742 |
| Guthrie..... | 6 | 13,723 | 21,354 | | | 35,082 |
| Hamilton..... | 7 | | 65,040 | | | 65,040 |
| Hancock..... | 1 | | | | | |
| Hardin..... | 12 | | 78,234 | 9,726 | | 88,010 |
| Harrison..... | 7 | | 24,150 | | | 24,150 |
| Henry..... | 6 | | 23,103 | | | 23,103 |
| Howard..... | 4 | | | 894 | | 894 |
| Humboldt..... | 3 | | | 1,307 | | 1,307 |
| Ida..... | 1 | | | | | |
| Iowa..... | 4 | | 28,775 | | | 28,775 |
| Jackson..... | 9 | | | 77,812 | | 77,812 |
| Jasper..... | 17 | 430,923 | 21,927 | | | 452,850 |
| Jefferson..... | 8 | 13,714 | 21,460 | | | 35,174 |
| Johnson..... | 8 | | 30,204 | 3,100 | | 33,304 |
| Jones..... | 12 | | | 78,055 | | 78,055 |
| Keokuk..... | 27 | 89,656 | 33,490 | 1,937 | | 125,083 |
| Kossuth..... | 1 | | | | | |
| Lee..... | 17 | | 14,900 | 22,873 | | 37,773 |
| Linn..... | 14 | | 27,922 | 31,613 | | 59,535 |
| Louisa..... | 7 | | 7,380 | 2,403 | | 9,783 |
| Lucas..... | 4 | 44,200 | | | | 44,200 |
| Madison..... | 1 | | | | | |
| Mahaska..... | 44 | 1,044,316 | 76,755 | | | 1,121,071 |
| Marion..... | 24 | 402,829 | 15,180 | | | 418,009 |
| Marshall..... | 10 | | 61,264 | | | 61,264 |
| Mills..... | 4 | | 14,100 | | | 14,100 |
| Mitchell..... | 3 | | | 2,413 | | 2,413 |
| Monona..... | 1 | | | | | |
| Monroe..... | 13 | 2,553,683 | | 478 | | 2,559,161 |
| Montgomery..... | 8 | | 29,792 | 1,390 | | 31,182 |
| Muscatine..... | 10 | | 43,965 | | | 43,965 |
| O'Brien..... | 1 | | | | | |
| Page..... | 6 | 43,530 | 32,000 | | | 75,530 |
| Pocahontas..... | 3 | | 42,850 | | | 42,850 |
| Polk..... | 44 | 1,779,699 | 592,018 | | | 2,371,717 |
| Pottawattamie..... | 7 | | 73,891 | | | 73,891 |
| Poweshiek..... | 3 | | 14,314 | | | 14,314 |
| Ringgold..... | 2 | | 8,800 | | | 8,800 |
| Sac..... | 2 | | 2,625 | | | 2,625 |
| Scott..... | 19 | 24,543 | 39,177 | 22,370 | | 86,090 |
| Shelby..... | 1 | | | | | |
| Sioux..... | 2 | | 7,800 | | | 7,800 |
| Story..... | 5 | | 23,677 | | | 23,677 |
| Tama..... | 7 | | 57,000 | | | 57,000 |
| Taylor..... | 9 | 35,358 | 8,472 | | | 43,830 |
| Union..... | 2 | | 17,333 | | | 17,333 |
| Van Buren..... | 10 | 13,633 | 6,900 | 396 | | 20,929 |
| Wapello..... | 20 | 564,453 | 88,272 | 22,255 | | 674,980 |
| Warren..... | 5 | 27,336 | | | | 27,336 |
| Washington..... | 11 | | 29,037 | 6,217 | | 35,254 |
| Wayne..... | 9 | 143,775 | 14,750 | | | 158,525 |
| Webster..... | 27 | 269,917 | 285,141 | 10,500 | 430,008 | 995,566 |
| Winneshiek..... | 2 | | 7,000 | | | 7,000 |
| Woodbury..... | 5 | | 224,408 | | | 224,408 |
| Wright..... | 4 | | 18,900 | | | 18,900 |
| Single producers..... | 39 | 5,400 | 110,466 | 60,715 | | 176,581 |
| Total..... | 404 | \$10,499,189 | \$ 3,033,583 | \$ 598,622 | \$ 439,021 | \$ 14,504,365 |

COAL.

The coal production shows an increase of more than fifteen per cent in ~~output and twenty-eight~~ per cent in the value of the product marketed. Most of the coal producing counties contributed to the increased output and profited by the increase in price. Keokuk is the only county showing a decided slump.

Table II gives the total tonnage, average price per ton, total value, number of mines producing, average number of days worked and number of men employed, arranged by counties.

TABLE No 2.

COAL OUTPUT BY COUNTIES FOR 1903.

| COUNTIES. | Number of producers. | Tons loaded at mine for shipment. | Sold to local trade or used by employes. | Used at mine for steam and heat. | Total tons produced. | Total selling value at mine. | Average price per ton. | Average number of days worked. | Average number of employes during the year. |
|-----------|----------------------|-----------------------------------|--|----------------------------------|----------------------|------------------------------|------------------------|--------------------------------|---|
| Adams | 9 | | 23,250 | 20 | 23,270 | \$ 57,700 | \$2.48 | 171 | 74 |
| Appanoose | 51 | 847,665 | 30,167 | 12,184 | 890,016 | 1,784,682 | 2.00 | 196 | 2,829 |
| Boone | 9 | 259,491 | 25,797 | 6,105 | 291,333 | 599,040 | 2.05 | 212 | 808 |
| Dallas | 3 | 6,493 | 8,131 | 900 | 15,467 | 30,424 | 2.35 | 114 | 70 |
| Davis | 1 | | 2,160 | | 2,160 | 5,400 | 2.50 | 270 | 7 |
| Greene | 9 | | 23,421 | 875 | 24,296 | 57,530 | 2.37 | 168 | 113 |
| Guthrie | 3 | | 4,708 | | 4,708 | 13,728 | 2.92 | 194 | 27 |
| Jasper | 11 | 203,346 | 58,740 | 8,751 | 270,837 | 430,923 | 1.59 | 280 | 611 |
| Jefferson | 5 | 1,700 | 4,421 | 326 | 6,447 | 13,714 | 2.19 | 148 | 27 |
| Keokuk | 10 | 50,496 | 10,654 | 2,553 | 63,945 | 89,656 | 1.40 | 164 | 172 |
| Lucas | 3 | 276,945 | 8,102 | 10,547 | 295,594 | 440,210 | 1.49 | 281 | 514 |
| Mahaska | 38 | 639,503 | 54,953 | 19,003 | 707,459 | 1,044,316 | 1.47 | 225 | 1,428 |
| Marion | 19 | 291,351 | 90,203 | 6,579 | 322,133 | 402,829 | 1.23 | 204 | 693 |
| Monroe | 11 | 1,693,114 | 48,078 | 31,862 | 1,768,054 | 2,558,683 | 1.44 | 258 | 2,928 |
| Page | 3 | | 16,538 | 5 | 16,543 | 43,530 | 2.63 | 137 | 69 |
| Polk | 25 | 726,476 | 269,819 | 35,870 | 1,032,165 | 1,770,699 | 1.72 | 266 | 1,743 |
| Scott | 6 | | 12,274 | 379 | 12,653 | 24,548 | 1.94 | 174 | 54 |
| Taylor | 5 | 8,981 | 7,932 | 20 | 16,933 | 35,353 | 2.08 | 217 | 78 |
| Van Buren | 4 | 4,348 | 7,973 | 40 | 12,361 | 13,633 | 1.10 | 211 | 34 |
| Wapello | 13 | 238,557 | 69,117 | 5,242 | 362,916 | 566,458 | 1.56 | 240 | 732 |
| Warren | 4 | 8,360 | 4,400 | | 12,760 | 27,336 | 2.14 | 167 | 33 |
| Wayne | 4 | 68,980 | 6,482 | 26 | 75,488 | 143,775 | 1.90 | 231 | 197 |
| Webster | 15 | 115,620 | 11,911 | 4,165 | 131,696 | 269,917 | 2.05 | 219 | 342 |
| Total | 261 | 5,485,249 | 734,731 | 145,751 | 6,365,233 | \$10,439,139 | \$1.64 | 232 | 13,583 |

CLAY.

The continued wet weather caused the abandonment of many of the hand yards but greatly stimulated the manufacture of drain tile. The increase in the production of tile more than compensated for the falling off in common brick. The product was distributed as follows:

| | THOUSAND. | VALUE. |
|------------------------|-----------|--------------------|
| Common brick..... | 194,872 | \$1,396,088 |
| Front brick..... | 7,381 | 83,306 |
| Paving brick..... | 20,688 | 221,481 |
| Ornamental brick | | 1,200 |
| Fire brick..... | | 975 |
| Drain tile..... | | 1,009,933 |
| Sewer pipe..... | | 88,000 |
| Hollow block..... | | 131,191 |
| Sidewalk brick | | 11,743 |
| Floor tile..... | | 500 |
| Railway ballast..... | | 12,000 |
| Pottery..... | | 55,762 |
| Miscellaneous | | 21,404 |
| Total..... | | <u>\$3,033 583</u> |

Every class of clay ware shows an advance in price and away from the Mississippi river district, most of the factories could not keep up with their orders.

The distribution of clay products by counties, showing the common brick and total brick in thousands, the values of common brick and of total brick, value of drain tile and total value of clay products are shown in Table III.

TABLE III.
CLAY PRODUCTION BY COUNTIES FOR 1903.

| COUNTIES. | Producers. | BRICK IN THOUSANDS. | | VALUE OF BRICK. | | Value of drain tile. | Miscellaneous. | Total value of clay products. |
|------------------|------------|---------------------|--------------|-----------------|--------------|----------------------|----------------|-------------------------------|
| | | Common brick. | Total brick. | Common brick. | Total brick. | | | |
| Adams..... | 16 | 1,940 | 1,940 | \$ 14,580 | \$ 14,580 | \$ 650 | \$ 1,200 | \$ 27,230 |
| Adair..... | 3 | 700 | 1,400 | 4,900 | 11,900 | 2,700 | 30 | 14,360 |
| Appanoose..... | 1 | | | | | | | |
| Audubon..... | 1 | | | | | | | |
| Cass..... | 2 | 1,406 | 1,406 | 10,596 | 10,596 | | | 10,596 |
| Benton..... | 5 | 830 | 830 | 5,815 | 5,815 | 16,200 | | 22,015 |
| Black Hawk..... | 2 | 1,500 | 1,500 | 10,375 | 10,375 | | | 10,375 |
| Boone..... | 5 | 6,208 | 6,208 | 58,791 | 58,816 | 24,150 | | 82,666 |
| Bremer..... | 2 | 273 | 273 | 2,193 | 2,193 | | | 2,193 |
| Buena Vista..... | 3 | 229 | 229 | 1,620 | 1,620 | 15,406 | | 17,026 |
| Butler..... | 1 | | | | | | | |
| Calhoun..... | 3 | 63 | 63 | 500 | 1,000 | 12,445 | 300 | 13,745 |
| Carroll..... | 1 | | | | | | | |
| Cedar..... | 1 | | | | | | | |
| Cherokee..... | 1 | | | | | | | |
| Clay..... | 1 | | | | | | | |
| Clarke..... | 1 | | | | | | | |
| Clayton..... | 4 | 1,860 | 1,860 | 11,603 | 11,003 | 2,019 | | 13,622 |
| Cerro Gordo..... | 3 | 3,537 | 3,537 | 25,182 | 26,586 | 194,222 | 35,504 | 258,415 |
| Clinton..... | 3 | 1,025 | 1,025 | 6,460 | 6,400 | 3,800 | | 10,260 |
| Crawford..... | 2 | 1,600 | 1,600 | 11,500 | 11,500 | | | 11,500 |
| Dallas..... | 3 | 2,983 | 3,469 | 22,815 | 30,187 | 66,438 | | 96,625 |
| Davis..... | 2 | 65 | 65 | 510 | 510 | | | 510 |
| Decatur..... | 2 | 625 | 625 | 4,600 | 4,600 | 150 | | 4,750 |
| Delaware..... | 2 | 1,000 | 1,100 | 6,300 | 7,300 | | | 7,300 |
| Des Moines..... | 3 | 1,769 | 2,521 | 13,481 | 21,520 | 1,500 | 4,000 | 27,020 |
| Dubuque..... | 4 | 5,485 | 5,485 | 35,595 | 35,595 | | | 35,595 |
| Fayette..... | 2 | 2,040 | 2,040 | 13,300 | 13,300 | 1,500 | 1,100 | 15,900 |
| Floyd..... | 1 | | | | | | | |
| Franklin..... | 1 | | | | | | | |
| Fremont..... | 5 | 1,500 | 1,500 | 9,750 | 9,750 | | | 9,750 |
| Greene..... | 1 | | | | | | | |
| Grundy..... | 2 | 200 | 200 | 1,537 | 1,537 | 205 | | 1,742 |
| Guthrie..... | 3 | 392 | 392 | 6,050 | 6,050 | 15,304 | | 21,354 |
| HAMILTON..... | 2 | 2,145 | 2,145 | 15,015 | 15,015 | 50,025 | | 65,040 |
| Hardin..... | 5 | 919 | 1,129 | 7,243 | 11,313 | 66,626 | 315 | 78,234 |
| Harrison..... | 7 | 3,371 | 3,371 | 24,150 | 24,150 | | | 24,150 |
| Hancock..... | 1 | | | | | | | |
| Henry..... | 5 | 1,161 | 1,161 | 8,244 | 8,244 | 14,859 | | 23,103 |
| Howard..... | 1 | | | | | | | |
| Humboldt..... | 1 | | | | | | | |
| Ida..... | 1 | | | | | | | |
| Iowa..... | 4 | 2,475 | 2,575 | 16,325 | 17,225 | 11,550 | | 28,775 |
| Jackson..... | 1 | | | | | | | |
| Jasper..... | 6 | 1,961 | 1,998 | 14,627 | 14,977 | 6,950 | | 21,927 |
| Jefferson..... | 3 | 620 | 620 | 4,960 | 4,960 | 16,500 | | 21,460 |
| Johnson..... | 6 | 2,375 | 2,933 | 20,300 | 20,764 | 9,200 | 240 | 30,204 |
| Jones..... | 1 | | | | | | | |
| Keokuk..... | 6 | 825 | 825 | 6,520 | 6,520 | 26,970 | | 33,490 |
| Kossuth..... | 1 | | | | | | | |
| Lee..... | 5 | 2,220 | 2,320 | 13,750 | 14,600 | 800 | | 14,900 |
| Linn..... | 8 | 3,010 | 3,010 | 21,170 | 21,170 | 6,752 | | 27,922 |
| Louisia..... | 2 | 510 | 510 | 3,630 | 3,630 | 3,750 | | 7,380 |

TABLE III.—CONTINUED.

| COUNTIES. | Producers. | BRICK IN THOUSANDS. | | VALUE OF BRICK. | | Value of drain tile. | Miscellaneous. | Total value of clay products. |
|------------------|------------|---------------------|--------------|-----------------|--------------|----------------------|----------------|-------------------------------|
| | | Common brick. | Total brick. | Common brick. | Total brick. | | | |
| Lucas | 1 | | | | | | | |
| Madison | 1 | | | | | | | |
| Mahaska | 5 | 4,402 | 7,448 | \$ 32,356 | \$ 63,205 | \$ 12,550 | \$ 1,000 | \$ 76,755 |
| Marion | 4 | 1,510 | 1,510 | 11,680 | 11,680 | 3,500 | | 15,180 |
| Marshall | 8 | 4,929 | 4,929 | 31,762 | 31,762 | 22,580 | 6,942 | 61,284 |
| Mills | 4 | 1,900 | 1,900 | 14,100 | 14,100 | | | 14,100 |
| Monona | 1 | | | | | | | |
| Montgomery | 5 | 2,893 | 2,923 | 23,161 | 23,611 | 1,081 | 5,100 | 29,792 |
| Muscatine | 8 | 4,970 | 4,970 | 32,500 | 32,500 | 4,425 | 7,040 | 43,965 |
| O'Brien | 1 | | | | | | | |
| Page | 3 | 4,000 | 4,000 | 28,000 | 28,000 | 4,000 | | 32,000 |
| Pocahontas | 2 | | | | | 42,850 | | 42,850 |
| Polk | 19 | 24,380 | 41,250 | 190,944 | 378,967 | 81,797 | 131,254 | 592,018 |
| Pottawattamie | 7 | 10,518 | 11,118 | 70,891 | 73,441 | 450 | | 73,891 |
| Poweshiek | 3 | 598 | 598 | 4,734 | 4,734 | 9,080 | 600 | 14,314 |
| Ringgold | 2 | 1,100 | 1,100 | 8,800 | 8,800 | | | 8,800 |
| Saunders | 2 | 375 | 375 | 2,625 | 2,625 | | | 2,625 |
| Scott | 6 | 3,521 | 4,521 | 22,627 | 33,327 | 1,000 | 4,850 | 39,177 |
| Shelby | 1 | | | | | | | |
| Sioux | 2 | 1,600 | 1,600 | 7,800 | 7,800 | | | 7,800 |
| Story | 5 | 704 | 744 | 5,617 | 5,677 | 17,700 | | 23,677 |
| Tama | 5 | 4,200 | 5,687 | 27,627 | 42,500 | 14,500 | | 57,000 |
| Taylor | 4 | 1,189 | 1,189 | 8,472 | 8,472 | | | 8,472 |
| Union | 2 | 1,916 | 1,916 | 15,258 | 15,258 | 1,950 | 190 | 17,398 |
| Van Buren | 4 | 950 | 950 | 6,900 | 6,900 | | | 6,900 |
| Wapello | 3 | 8,516 | 9,451 | 59,580 | 63,792 | 13,270 | 6,210 | 83,272 |
| Warren | 1 | | | | | | | |
| Washington | 3 | 2,753 | 2,753 | 18,743 | 18,743 | 10,294 | | 29,037 |
| Wayne | 5 | 1,650 | 1,350 | 9,950 | 9,350 | 5,400 | | 14,750 |
| Webster | 9 | 10,833 | 11,833 | 65,400 | 72,400 | 133,359 | 71,382 | 285,141 |
| Winneshiek | 2 | 1,025 | 1,025 | 7,000 | 7,000 | | | 7,000 |
| Woodbury | 5 | 25,115 | 26,536 | 185,850 | 199,733 | 5,807 | 18,063 | 224,408 |
| Wright | 4 | 125 | 125 | 1,000 | 1,000 | 17,900 | | 18,900 |
| Single producers | 23 | 9,228 | 9,828 | 73,187 | 74,534 | 31,379 | 500 | 110,466 |
| Total | 323 | 194,872 | 224,142 | \$1,400,091 | \$1,718,200 | \$1,009,993 | \$307,450 | \$3,083,593 |

STONE.

The stone production shows a decline as compared with the two years preceding, probably due to the continued wet weather. The production for 1903 was distributed as follows:

Limestone used for:

| | |
|-------------------|-----------|
| Building purposes | \$204,769 |
| Flagging | 2,388 |
| Curbing | 2,318 |
| Paving | 9,087 |
| Lime | 113,195 |
| Rubble | 65,307 |
| Riprap | 37,096 |

Crushed stone:

| | |
|----------------------|------------------|
| Roadmaking..... | 63,637 |
| Railway ballast..... | 12,243 |
| Concrete..... | 68,763 |
| Miscellaneous..... | 2,158 |
| Sandstone..... | 17,004 |
| | <u>\$597,965</u> |

Table IV gives the production by counties and specifies the various grades of stone put upon the market.

TABLE No. 4.
PRODUCTION OF LIMESTONE BY COUNTIES FOR 1903.

| Counties. | Building. | Flagging curb- ing and pav- ing. | Lime. | Road making. | Railway ballast and concrete | Rubble and chiprap. | Miscellaneous. | Total. |
|-----------------------|-----------|--|-----------|--------------|---------------------------------|------------------------|----------------|-----------|
| Adams..... | \$..... | \$..... | \$..... | \$..... | \$..... | \$..... | \$..... | \$..... |
| Allamakee..... | 368 | | 75 | | | 58 | | 479 |
| Appanoos..... | 150 | 60 | | | | 500 | | 710 |
| Benton..... | 975 | | 105 | 25 | | 60 | | 1,165 |
| Black Hawk..... | 12,933 | 1,318 | | | 1,216 | 25 | | 15,492 |
| Buchanan..... | | | | | | | | |
| Cedar..... | 11,553 | | 1,350 | 41,062 | 2,306 | 3,511 | | 59,782 |
| Cerro Gordo..... | 13,922 | 254 | 4,300 | | 15,000 | 469 | | 34,145 |
| Clarke..... | 608 | 128 | | 32 | 19 | 100 | | 882 |
| Clayton..... | 5,588 | 640 | 2,075 | 100 | | 3,133 | | 11,536 |
| Clinton..... | 1,005 | 40 | | 2,777 | | 748 | | 4,570 |
| Dallas..... | 20,128 | | | | | | | 20,128 |
| Decatur..... | 2,017 | 2,490 | | 1,825 | 2,400 | 14 | 23 | 8,769 |
| Delaware..... | 4,900 | 220 | | | | 120 | | 5,240 |
| Des Moines..... | 972 | 45 | | 30 | | 6,880 | | 7,877 |
| Dubuque..... | 11,194 | 1,956 | 13,600 | 923 | 11,425 | 16,168 | 295 | 54,951 |
| Fayette..... | 5,575 | | 1,500 | | | | | 7,375 |
| Floyd..... | 3,600 | 450 | | | 450 | | 650 | 5,050 |
| Grundy..... | | | | | | | | |
| Hamilton..... | | | | | | | | |
| Hardin..... | 9,704 | 22 | | | | | | 9,726 |
| Henry..... | | | | | | | | |
| Howard..... | 890 | 4 | | | | | | 894 |
| Humboldt..... | 1,907 | | | | | | | 1,907 |
| Jackson..... | 1,027 | 160 | 75,910 | 615 | 50 | 50 | | 77,812 |
| Johnson..... | 280 | | | 1,120 | | 1,720 | | 3,100 |
| Jones..... | 43,021 | 416 | | 1,323 | 7,568 | 25,732 | | 78,055 |
| Keokuk..... | 1,705 | 12 | | 32 | | 138 | | 1,937 |
| Lee..... | 4,096 | 5,303 | | 1,200 | 8,045 | 1,606 | 1,233 | 21,570 |
| Linn..... | 7,210 | | 12,000 | 690 | 6,510 | 5,203 | | 31,613 |
| Louisia..... | 2,015 | 20 | | | 8 | 560 | | 2,403 |
| Mahaska..... | | | | | | | | |
| Marion..... | | | | | | | | |
| Marshall..... | | | | | | | | |
| Mitchell..... | 663 | | 1,750 | | | | | 2,413 |
| Monroe..... | 270 | 8 | | | | 200 | | 478 |
| Montgomery..... | 1,390 | | | | | | | 1,390 |
| Pocahontas..... | | | | | | | | |
| Scott..... | 6,107 | 75 | | 11,618 | 4,570 | | | 22,370 |
| Tama..... | | | | | | | | |
| Van Buren..... | 240 | 6 | | | | 150 | | 396 |
| Wapello..... | 10,241 | | | 850 | 3,973 | 7,136 | | 22,255 |
| Washington..... | 6,217 | | | | | | | 6,217 |
| Single producers..... | 12,565 | | | | 17,461 | 27,274 | 60 | 58,876 |
| Total..... | \$704,780 | \$18,703 | \$119,195 | \$63,637 | \$81,006 | \$102,403 | \$2,158 | \$570,961 |

THE PRODUCTION OF SANDSTONE BY COUNTIES FOR 1903, IS SHOWN IN TABULAR FORM BELOW.

| Counties. | Number of Producers. | Building. | Rubble, Riprap, etc. | Total. |
|-----------------------|----------------------|-----------|----------------------|-----------|
| Clayton..... | 2 | \$ 3,095 | \$ 267 | \$ 3,362 |
| Des Moines..... | 1 | | | |
| Fayette..... | 1 | | | |
| Jones..... | 1 | | | |
| Lee..... | 3 | 816 | 487 | 1,303 |
| Scott..... | 1 | | | |
| Tama..... | 1 | | | |
| Webster..... | 2 | 500 | 10,000 | 10,500 |
| Single Producers..... | | 1,641 | 198 | 1,839 |
| Total..... | 12 | \$ 6,052 | \$ 10,952 | \$ 17,004 |

GYPSUM.

The price of gypsum products shows a considerable advance over that for the preceding year. The amount marketed was also somewhat greater than for 1902. The output of gypsum was reported to be 166,713 tons of crude gypsum valued at \$317,326 and sold as:

| | TONS | VALUE. |
|-----------------------------|---------|-----------|
| Wall cement or plaster..... | 87,397 | \$411,503 |
| Plaster of Paris..... | 30,306 | 100.74 |
| Land plaster..... | 2,098 | 9,227 |
| Crude Gypsum..... | 703 | 1,534 |
| Total..... | 120,504 | \$523,008 |

LEAD AND ZINC.

The lead industry about Dubuque still continued to decline. The outlook for 1904 is much more promising as the amount of ore marketed before July 1st exceeded that for the entire preceding year. A small quantity of zinc ore was produced but none was sold. Prospecting and development work continues. The output of lead was as follows:

Galena 120,450 pounds sold for \$3,013.

No zinc was put upon the market during 1903.

INDEX.

- Absorption tests, 564, 608.
 Acknowledgments, 642.
 Adams county, 415.
 Adair county, 415.
 Administrative report, 1.
 Advantages of hollow blocks, 599.
 paving brick, 602.
 the open heater, 365.
 Alkalis, 66, 336.
 Allamakee county.
 Alluvium, 48.
 Aluminum and iron, 335.
 Alternate specifications for boiler 66" x
 18', 358.
 American Brick and Tile Co., 109, 398.
 Ames and Kelly brick, 579.
 Analyses of clays, 42, 52, 55, 112, 131,
 219, 220, 223, 224, 226,
 228, 229, 231, 232, 233,
 322, 323, 324, 325, 330,
 386, 387, 389, 392, 393,
 396, 398, 401, 406, 422,
 426, 431, 437, 438, 445,
 465, 468, 471, 472, 473,
 475, 489, 499, 502, 505,
 506, 510, 512, 513, 518,
 540, 541, 543, 545, 546,
 548, 549.
 coal, 262, 263, 264, 265,
 266, 267, 370.
 fuel gases, 268.
 Iowa coals, 370.
 Appanoose county, 415.
 Arey, M. F., 6.
 Aron, Dr., 97.
 Augusta stage, The, 409.
 Automatic clay gatherer, 157.
 indenting brick cutter, 198.
 Bain, H. F., cited, 463.
 Ball mills, 174.
 Barringer, L. E., 219.
 Besley Brick Company, 109, 116, 577.
 tested, 577.
 Beyer, S. W., 4.
 Clay and clay industries
 of Iowa, 27.
 Directory of Iowa clay
 workers, 621.
 Geology of clays, 376.
 Mineral production for
 1902, 7.
 Mineral production for
 1903, 647.
 Technology of clays, 29.
 Beidermann, 92.
 Bischof, Dr. Carl, 98, 100, 119.
 Formula of, 135.
 Bissell, G. W., 262.
 Clays and clay indus-
 tries of Iowa, 27.
 Selection, installation
 and care of power
 plants, 347.
 Calcium, 336.
 Calculation of results, 619.
 Calhoun county, 509.
 Calorific power of Iowa coals, 371.
 Calvin, S., 6.
 Administrative report, 3.
 Work in Winneshiek county, 6.
 Campbell Brick and Tile Company, 508.
 Capital City Brick and Pipe Company,
 109, 116.
 Tests of clays of, 604.
 Carboniferous period, 402.

- Castings of boilers, 357.
 Centerville Brick and Tile Company, 417.
 Cerro Gordo county, 396.
 Changes which occur in the burning of clays, 274.
 Chemical analyses of clays, 330, 333.
 Value of, 339.
 Chemistry of clays, 319.
 Chemistry of rock composition, 322.
 Classes of clays, 325.
 Classification of clays, 37.
 Buckley's, 39.
 Ladd's, 37.
 Orton's, 40.
 Clay county, 549.
 Clay crusher, 166, 167.
 disintegrators, 168.
 Fire, 44, 325.
 Flint, 45.
 red, The, 532.
 Slip, 223.
 Workers, Directory of Iowa, 621.
 Clays, Bonding power of, 85.
 Changes which occur in burning of, 274.
 Colors of, 70, 340.
 Composition and chemical properties of, 52.
 Definition of, 35.
 deposited from running water, 68.
 deposited in still water, 44.
 Feel of, 72.
 Fineness of grain of, 116.
 Fire, 44.
 Fusibility of, 123.
 Fusion tests of, 147.
 Physical properties of, 69.
 Plasticity of, 46, 87.
 Porosity of, 109, 112, 113.
 Preparation of raw, 163.
 Shrinkage of, 103.
 Slaking of, 72.
 Specific gravity of, 114.
 Strength of, 74.
 Structure of, 69.
 Clay wares, Burning of, 261.
 Drying of, 234.
 Processes in the manufacture of, 32.
 Clay wares produced in 1902, Value of, 18.
 produced in 1903, Value of, 651.
 Clayton county, 385.
 Clermont Brick and Tile Company, 109.
 Clinton county, 387.
 Coal, 12.
 produced for 1902, 14.
 produced in 1903, 652.
 Coal Measures, 410.
 Cold water feeder, 362.
 Colesburg potter's clays, 109.
 Pottery Company, 388.
 Combustion of fuel, 261.
 Comparison of brick tests, 571, 592.
 Composition of pholerite, 52.
 Compression tests on brick, 562.
 Cones Seger, table of fusing points, 141.
 Construction of boilers, 357.
 Construction of open feed-water heaters, 366.
 Continuous kiln, 315.
 Continuous tunnel drier, 252.
 Corey Pressed Brick Company, 109, 116, 506.
 Cratty, R. I., 6.
 Cream City Brick and Tile Company, 401.
 Cretaceous period, 509.
 Crushing tests of brick, 608.
 Cutting tables, 197, 201.
 Dale Brick Company, 109, 116.
 tested, 578.
 Dallas county, 424.
 Decatur county, 430.
 Definition of clays, 35.
 Dehydration, 275.
 Delaware county, 388, 529.
 Des Moines county, 403, 429.
 Desirable types of boilers, 353.
 Determination of alkalis, 336.
 aluminium, 335.
 calcium, 336.
 clays, 334.
 ferris oxide, 338.
 magnesium, 336.
 sulfur, 339.
 titanic oxide, 339.
 Devonian period, The, 395.

- Dimensions of boilers, 356.
 machines, 618.
 Direct radiation, 255.
 Directory of Iowa Clay Workers, 621.
 Disintegrators, 168.
 Down draft kilns, 292.
 Drain tile, 213.
 and hollow block, 231.
 Dry pans, 170.
 Dry methods of clay preparation, 163.
 Dry pressed brick, 209, 229.
 Drying of clays, 234.
 Drying by fuel burned for the purpose, 256.
 Drying by radiation from heated brick works, 258.
 Drying by radiation from heated surfaces, 259.
 Drying by waste gases, 257.

 Earthenware, 232.
 Effect of chemical composition on fusibility of clays, 129.
 Effect of physical condition on fusibility of clays, 132.
 Effective power calculated in engines, 373.
 Eldora Pipe and Tile Company, 473.
 End-dumping clay car, 161.
 Engines, 373.

 Fairbanks cement machine, 80.
 Fayette county, 393.
 Feed-water heaters, 362.
 Feldspar, 57.
 Ferrous oxide, 338.
 Fire clay, 325.
 Firing of boilers, 369.
 Fittings of boilers, 357.
 Flint Brick Company, 109.
 Clay tests of, 604.
 Floyd county, 400.
 Formation of clays, 185.
 clay wares, 185.
 Foundation for engines, 374.
 Franklin county, 402.
 Fremont county, 432.
 Freezing and thawing tests, 565.
 Freezing tests, Results of, 590.

 Galena-Trenton limestone, 383.
 General consideration of clays, 234.
 Geological distribution of clays, 381.
 Geology of clays, 378.
 Gethmann Bros. Brick Co., 109, 560.
 Analysis of clay, 545.
 Glazing, Stoneware, 218.
 Bristol, 225.
 Salt, 219.
 Slip, 223.
 Temperatures of, 47.
 Grand Junction brick tests, 578.
 Grand Junction brickyard, 578.
 Granite Brick Company, 109, 404.
 Test of brick of, 604.
 Greene county, 432.
 Gumbo, The, 534.
 Guthrie county, 433.
 Gypsum production in 1902, 26.
 production in 1903, 655.

 Haigh continuous kiln, 522.
 Hamilton county, 435.
 Hardin county, 436.
 Hatt, W. K., 616.
 Haworth, E., 93.
 Hedzfeld, 92.
 Hollow blocks, 213, 231.
 Advantages of, 599.
 Tests of, 600.
 Holman & Brother brick plant, 517.
 Clay pit of, 517.
 Honestone quarries, 439.
 Horizontal type soft mud brick machine, 190.
 Hoskin's muffle furnace, 81.
 Hot floor dryer, 249.
 Hubinger Brick Works, 410.
 Humboldt county, 440.

 Illinoian drift, The, 528.
 Impurities in clays, 55.
 Inclined stationary screen, 179.
 Inclined vibrating screen, 180.
 Incrustation on brick walls, 341.
 Indirect radiation, 255.
 Inspection and test of boilers, 357.

- Iowa Brick Company, 468.
 Clay analysis of, 471.
 Clay pit of, 470.
 Clay tests of, 604.
 Iowa coals, Study of, 262.
 Iowan drift, The, 528.
 Iowan loess, The, 538.
 Iron in glaze, 58, 335, 548.
- Jasper county, 440.
 Jaw type of rock crusher, 164.
 Jefferson county, 441.
 Jester, B. B. Fire clay of, 113, 116.
 Johnson, J. B., 616.
 Jolly, Potter's, 216.
- Kansan drift, The, 526.
 Kaolinite, Composition of, 35.
 Origin of, 36.
 Kelly Brick and Tile Works, Pit of, 539.
 Clay of 579.
 Tests of brick
 of, 583, 593,
 595.
- Keokuk county, 444.
 Key to kinds of brick, 559.
 Kilns, Types of, 288.
 Continuous, 314.
 Downdraft, 292.
 Direct rectangular, 309.
 Direct round, 292.
 Muffle, 313.
 Up-draft, 289.
 American scove, 289.
 English clamp, 289.
 Pottery, 290.
 Muffle, 291.
 Kinderhook stage, The, 403.
- Ladd, G. E., 99.
 Lagging of steam pipes, 374.
 Langenbeck, 99, 329.
 Lead production in 1902, 26.
 in 1903, 655.
 Lee county, 407, 446.
 Leonard, A. G., 6.
 Lime in clays, 62.
 production in 1902, 22.
 in 1903, 653.
- Limestone production in 1902, 23.
 in 1903, 654.
- Loam, 49.
 Loess, 529.
 Analysis of, 545, 546.
 deposited by winds, 51.
 The Iowan, 538.
- Lucas county, 447.
 Macbride, T. H., 6.
 Machinery of power plants, 352.
 Madison county, 447.
 Magnesium, 65, 336.
 sulfate, (6).
- Mahaska county, 450.
 Manner of testing brick, 575.
 Manufacture of brick, 185, 212.
 drain tile, 185, 212.
 hollow block, 212.
 pottery, 185, 215.
 sewer pipe, 214.
- Maquoketa shales, 384.
 Marion county, 452.
 Marston, A., 27, 555, 616.
 Mason City Brick and Tile Co., 400.
 Analysis of clay of, 396.
 Pit section of, 396.
 Tests of brick of, 578, 579,
 583, 586, 587, 595.
- McBirney, J. F., 574.
 Merrill Brick Co., Plant of, 476.
 Pit section of, 475.
 Tests of brick of, 604,
 608, 612, 617, 620.
- Methods of expressing fusibility, 133.
 firing, 372.
 measuring fusibility, 136.
 plasticity, 96.
 preparing clay for fusion
 tests, 144.
 used in rational analysis, 327.
- Mica in clays, 57.
 Minter, J. E., 214.
 Mineral production of Iowa for 1901, 9.
 for 1902, 9.
 for 1903, 647.
- Moisture in clays, 334.
 Monroe Brick and Tile Company, 441.
 Monroe county, 451.
 Montgomery county, 457, 511.
 Muffle down draft kilns, 313.

- Multiple stack kilns, 312.
Muscatine county, 459.
- National Brick Man'f's. Association,
208, 613, 614, 617.
Nichols, F. I., 574.
Northwestern Sewer Pipe and Tile
Company, 520.
 Pit section of, 520.
Norton, W. H., 4.
Number of producers of minerals in
1902, 11.
Number of producers of minerals in
1903, 648.
- Object of analyses of clays, 326.
 of rational analysis, 326.
 of ultimate analysis, 326.
Oneota limestone, 382.
Open air drying of clays, 247.
Open feed-water heaters, 364.
 Advantages of, 365.
 Construction of, 366.
 Requirements of, 367.
Origin of clays, 35.
Orton, Edw., Jr., cited, 40, 41, 77, 91,
223, 606.
- Page county, 461.
Percentage of fuel saved by heating
feed-water, 364.
Periodic or chamber dryer, 250.
 kiln, 314.
Physical properties of clay, 69.
Plastic clay, 325.
Plasticity of clays, 87.
Platt Pressed and Fire Brick Company,
424.
 Analyses of clay of, 426.
 Pit sections of, 425.
 Tests of brick of, 559.
Pleistocene period, The, 525.
Plymouth county, 512.
Pocahontas county, 550.
Polk county, 463.
Porcelain clay, 325.
Porosity of clays, 109.
Portland cement, 5.
Post-Wisconsin, 552.
- Pottawattamie county, 513.
Potteries at Sioux City and Sargents
Bluff, 522.
Pottery, Manufacture of, 215.
Power house, The, 351.
Power plants, Selection of, 349.
Poweshiek county, 477.
Practical consideration in drying clays,
244.
Pre-Kansan or Albertan stage, 526.
Preparation of raw clays, 163.
Primary or residual clays, 40.
Processes in the manufacture of clay
wares, 148.
Production of clay goods in 1902, 17.
 in 1903, 651.
 of coal in 1902, 12.
 in 1903, 650.
 of gypsum in 1902, 26.
 in 1903, 655.
 of lead and zinc in 1902, 26.
 in 1903, 655.
 of stone in 1902, 22.
 in 1903, 653.
Properties of clays used in manufac-
ture, 226.
 to be observed in selection
 of engines, 373.
Pug mill, 176.
Pyrometer, La Chatelier's, 139, 146.
- Quarries, Honestone, 439.
Quarrying, 152.
- Raney Bros Brick and Tile Plant, 443.
 Section of clay pit of, 443.
Rating formula, 595.
Rational analysis of clays, 327, 344, 345.
 Object of, 326.
Rattler test of paving brick, 613.
 Specifications for, 617.
 Table of, 620.
Rectangular down draft kiln, 309.
Red clay, 532.
Report of State Geologist, 3.
Repressing, 202.
 Advantages of, 208.
 Effects of, 206.
Requirements of open heater, 367.
 of power plants, 350.

- Results of absorption tests, 589.
 freezing tests, 590.
 rattler tests, 613.
 transverse tests, 587.
 tests of Ames brick, 597.
 tests of Council Bluffs brick, 588.
 tests of Goodwin brick, 590.
 tests of Grand Junction brick, 591.
 tests of Kelly brick, 593.
 tests of Mason City brick, 586.
 tests of Webster City brick, 588.
- Revolving screen, 183.
 Riveting boilers, 356.
 Robinson, W. S., 426.
 Rolls for clay crushing, 165.
 Rotary screens, 181.
 Round down draft kilns, 292.
- Sac county, 514.
 Saint Croix sandstone, 383.
 Saint Louis limestone, 410.
 Saint Peter sandstone, 353.
 Salt glazing, 219.
 Savage, T. E., 6.
 Scott county, 479.
 Screens, 179.
 Dunlap, The, 184.
 Inclined stationary, 179.
 Inclined vibrating, 180.
 Rotary, 181.
- Secondary clays, 44.
- Section at Ackworth, 491
 Barber Asphalt Co., 473.
 Bear creek, 484.
 Bevington, 449.
 Big Spring, 388.
 Birch creek, 441.
 Bluff creek, 454.
 Boone Clay Works, 420.
 Booneville, 424.
 Burlington Junction, 462.
 Butlerville, 461.
 Carlisle, 492.
 Cedar creek, 442.
 Centerville, 415.
 Chariton creek, 448.
 Clermont, 391.
- Section at Coal creek, 453.
 Coalville, 449, 503.
 Competine creek, 444.
 Cottonwood Mills, 427.
 Danville, 430.
 Davenport Brick and Paving Company, 479.
 De Kalb, 429.
 Delta, 445.
 Des Moines, 463.
 Douds Station, 483.
 Eldora, 436.
 Elrick Junction, 408.
 Fate Quarry, 459.
 Flint brickyards, 470.
 Ft. Dodge Clay Works, 497.
 Ft. Dodge Brick and Tile Company, 496.
 Gifford, 439.
 Glendon, 435.
 Graf, 391.
 Granite Brick Company, 404.
 Grant City, 510.
 Greenbush, 493.
 Guilford township, 456.
 Hackberry Grove, 396.
 Hamburg, 432.
 Hanging Rock, 428.
 Hawarden, 515.
 High Bridge, 429.
 Indian creek, 482.
 Iowa Falls, 440.
 Iowa Pipe and Tile Co., 477.
 Keokuk, 409.
 Kime brickyard, 495.
 Lake creek, 510.
 Le Claire Brick and Tile Company, 481.
 Lehigh, 508.
 Lehigh Brick and Tile Company, 505.
 Liberty township, 443.
 Linden, 428, 434.
 Lynville, 441.
 Manchester, 529.
 Martinsburg, 446.
 Mason City Brick and Tile Company, 396.
 Merrill Brick Plant, 476.
 Middle Raccoon, 428.

- Section at Muchakinock, 451.
 Muscatine, 461.
 Nevada, 482.
 Northwestern Sewer Pipe and Tile Company, 520.
 Oak Park, 466.
 Oskaloosa, 451, 452.
 Ottumwa, 485.
 Panora, 434.
 Parish, 430.
 Pleasant township, 454.
 Prospect Hill, 404.
 Raccoon, 424.
 Raccoon River, 473.
 Rand park, 446.
 Red creek, 407.
 Red Oak, 511.
 Riverside mine, 433.
 Rockford, 401.
 Sargents Bluff, 516.
 Sheffield, 402.
 Sioux City Paving Brick Co., 520.
 Sioux township, 511.
 Spring Hill, 493.
 St. Charles, 448.
 Sugar creek, 487, 488.
 Summit, 492.
 Sweetland township, 460.
 Union township, 490.
 Villisca, 459.
 Walnut creek, 419.
 Whitebreast creek, 447, 453.
 Seger's formulæ, 242.
 Seger volumeter, 115.
 Selection, installation and care of power plants, 347.
 of power plants, 350.
 Self-oiling bearings, 374.
 Semi-muffle furnace, 291.
 Sewer pipe, 232.
 Manufacture of, 214.
 Sewer pipe or slatted floor drying, 249.
 Shale pit of Mason City Brick and Tile Company, 397.
 Shaking grate, 353.
 Shrinkage in clays, 103.
 Side-dumping clay car, 160.
 Silica in clays, 55.
 Silurian period, The, 395.
 Single stack kilns, 293, 310.
 Sioux City Brick and Tile Co., 522.
 Sioux county, 514.
 Sioux Paving Brick Company, 520.
 Slaking of clays, 72.
 Slip glazing, 223.
 Smith, George A., 574.
 Smith's method of determining alkalis, 337.
 Soaking pit, 177.
 Soaking pit and wooden pug mill, 186.
 Soft mud brick, 185, 227.
 Specifications for horizontal return of tubular boiler, 356.
 for standard method of conducting rattler tests, 617.
 Specific gravity of clays, 114.
 Stewart, J. E., 574.
 Stiff mud brick, 185, 228.
 Stiff mud, 192.
 Stone produced in 1902, 22.
 in 1903, 653.
 Stoneware, 233.
 glazing, 218.
 Storm Lake Brick and Tile Company, 109.
 Story county 481.
 Strength of clays, 74.
 Structure of brick tested, 580.
 of clays, 69.
 Sulphur, 339.
 Summary of clays, 260.
 of brick tests, 573.
 Surface digging, 151.
 Table of Seger's cones, 141.
 showing comparative results of brick tests, 595.
 showing fusion temperatures of Iowa clays, 147.
 showing numerical value of rattler tests, 620.
 Talbot, A. N., 614, 615.
 Taylor county, 482.
 Technology of clays, 29.
 Temperature of fusion of clays, 147.
 Tensile strength of clays, 83.
 Tests of clay products, 557.
 dry press building brick, 558,

- Tests of hollow blocks, (00.
 Iowa common brick, 574.
 Iowa paving brick, 601.
- Titanic oxides, 338.
- Topographic work of the U. S. Survey,
 4, 5.
- Transmission belts, 375.
- Transportation of raw clay to works,
 156.
- Transverse tests of Iowa brick, 563.
- Tubes and braces of boilers, 356.
- Types of kilns, 288.
- Udden, J. A., 6.
- Udden, Jan Andreas, 6.
- Ultimate analyses of clays, 344.
 Object of, 326.
- Uncommon constituents in clays, 68.
- Union county, 483.
- Up draft kilns, 289.
- Use of exhaust steam in heating drying
 room, 375.
- Uses of limestone, 22.
- Value of chemical analyses, 339.
 of clay products 1902, 18.
 1903, 651.
 of coal products 1902, 14.
 1903, 650.
 of gypsum 1902, 26.
 1903, 655.
 of lead and zinc 1902, 26.
 1903, 655.
 of stone 1902, 22.
 1903, 653.
 of total mineral production
 1902, 9, 11.
 1903, 647, 648.
- Valve dampers, 305.
- Van Buren county, 483.
- Ventilation, 376.
- Vertical type of soft mud machine, 189.
 of stiff mud machine, 193.
- Villisca Brick and Tile Company, 459.
- Vitrification of clays, 283.
- Wapello county, 484.
- Warren county, 490.
- Washington county, 408.
- Wayne county, 494.
- Webster City Brick and Tile Company,
 435.
- Webster City brick tested, 577.
- Webster county, 494.
- Weems, J. B., 319, 642.
- Wet method of clay preparation, 175.
- Wet pan, 175.
- Wheeler, cited, 52, 90, 93.
- Wheeler's formula, 136.
- Whitney, Professor, cited, 90, 119.
- William's disintegrator and pulverizer,
 169.
- Williams, I. A., 6.
 Clays and clay industries of
 Iowa, 27.
 Directory of Iowa clay work-
 ers, 621.
 Geology of clays, 376.
 Technology of clays, 29.
- Winneshiek county, 394.
- Winning of raw clays, 148.
- Wisconsin drift, The, 547.
- Woodbury county, 515.
- Work in Winneshiek county, 6.