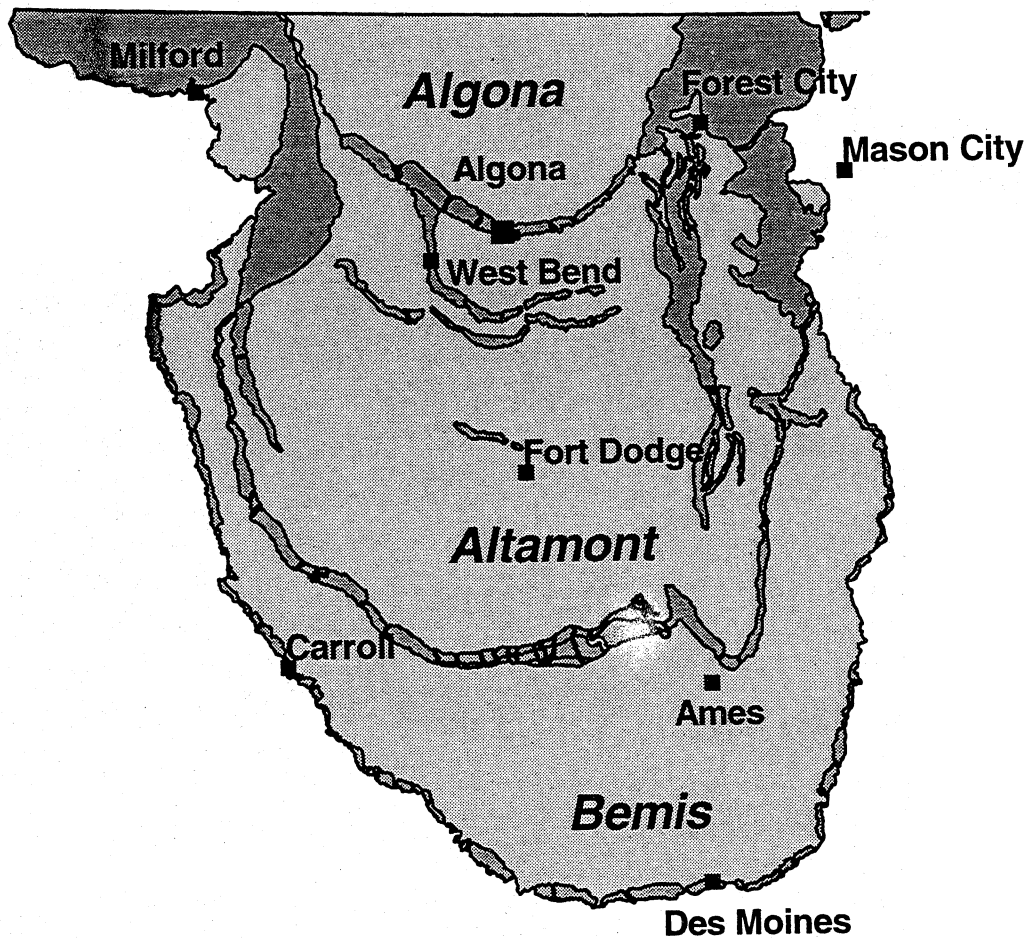


# HOGS, BOGS, & LOGS: QUATERNARY DEPOSITS AND ENVIRONMENTAL GEOLOGY OF THE DES MOINES LOBE

Geological Survey Bureau  
Guidebook Series No. 18



Iowa Department of Natural Resources  
Larry J. Wilson, Director  
May 1996

**HOGS, BOGS, & LOGS:  
QUATERNARY DEPOSITS AND ENVIRONMENTAL GEOLOGY  
OF THE DES MOINES LOBE**

**Geological Survey Bureau  
Guidebook Series No. 18**

*Prepared by*

E. Arthur Bettis III and Deborah J. Quade  
Geological Survey Bureau  
Energy and Geological Resources Division  
Iowa Department of Natural Resources

Timothy J. Kemmis  
Rust Environment and Infrastructure  
4738 N. 40th St.  
SheyboGAN, WI 53083

*with contributions by*

Richard G. Baker  
Department of Geology  
University of Iowa  
Iowa City, IA 52242-1319

Angela Reick-Hinz  
Iowa State Extension  
Iowa State University  
Ames, IA 50011

Aaron L. Steinwand  
Inyo County Water Department  
163 May St.  
Bishop, CA 93514

Thomas E. Fenton  
Agronomy Department  
Iowa State University  
Ames, IA 50011

Donald P. Schwert  
Department of GeoSciences  
North Dakota State University  
Fargo, ND 58105-5517

Carol A. Thompson  
Geological Survey Bureau  
109 Trowbridge Hall  
Iowa City, IA 52242-1319

Robert D. Libra  
Geological Survey Bureau  
109 Trowbridge Hall  
Iowa City, IA 52242-1319

Lynette S. Seigley  
Geological Survey Bureau  
109 Trowbridge Hall  
Iowa City, IA 52242-1319

Holly J. Torpen  
Department of GeoSciences  
North Dakota State University  
Fargo, ND 58105-5517

**North-Central Section Annual Meeting  
Geological Society of America**

Iowa State University  
Ames, Iowa

**Field Trip No. 5**

May 1996

**Iowa Department of Natural Resources  
Larry J. Wilson, Director**





## TABLE OF CONTENTS

ACKNOWLEDGEMENTS . . . . .	vii
PREFACE . . . . .	ix
INTRODUCTION . . . . .	1
STRATIGRAPHIC FRAMEWORK FOR THE DES MOINES LOBE . . . . .	7
DOWS FORMATION . . . . .	7
Alden Member . . . . .	10
Morgan Member . . . . .	15
Lake Mills Member . . . . .	18
Pilot Knob Member . . . . .	21
NOAH CREEK FORMATION . . . . .	22
PEORIA FORMATION. . . . .	24
DEFOREST FORMATION . . . . .	26
Flack Member . . . . .	27
Woden Member. . . . .	29
West Okoboji Member . . . . .	31
AN INTERIM LANDFORM CLASSIFICATION FOR THE DES MOINES LOBE . . . . .	31
A DESCRIPTIVE CLASSIFICATION . . . . .	33
Drainage/Depressional Features . . . . .	33
Upland Landforms . . . . .	34
Relief . . . . .	42
A FRAMEWORK FOR UNDERSTANDING THE DES MOINES LOBE . . . . .	42
A NEW MODEL FOR THE DES MOINES LOBE . . . . .	44
REFERENCES . . . . .	45
GLOSSARY . . . . .	49
DES MOINES LOBE (DML) ROAD LOG . . . . .	53
Day 1 Log . . . . .	55
Day 2 Log . . . . .	68
REFERENCES . . . . .	79
STOP DISCUSSIONS AND DESCRIPTIONS . . . . .	81

STOP 1: LANDSCAPE EVOLUTION OF A TILL LANDSCAPE IN THE CLARION-NICOLLET-WEBSTER SOIL ASSOCIATION AREA IN CENTRAL IOWA . . . . .	. 83
BACKGROUND . . . . .	. 83
METHODS. . . . .	. 83
RESULTS AND DISCUSSION . . . . .	. 85
Geomorphic Evolution . . . . .	. 85
Hydrology . . . . .	. 90
SUMMARY . . . . .	. 91
REFERENCES . . . . .	. 93
STOP 2: NATIONAL GYPSUM CO., KAUFFMAN-GEORGE PIT, FORT DODGE, IOWA . . . . .	. 95
INTRODUCTION . . . . .	. 95
STRATIGRAPHY . . . . .	. 95
<i>Insect Remains: A Faceted Eye's Perspective on the Advance of the Des Moines Lobe into North-Central Iowa.</i> . . . .	. 99
Introduction . . . . .	. 99
Sample Section, Ages, and Procedures . . . . .	. 99
Faunal Syntheses . . . . .	. 102
Discussion . . . . .	. 104
<i>Pollen and Plant Macrofossils.</i> . . . .	. 105
Introduction . . . . .	. 105
Results . . . . .	. 105
Discussion . . . . .	. 105
References . . . . .	. 109
STOP 3. STRATIGRAPHY OF A LINKED-DEPRESSION SYSTEM, INDIAN CREEK, HUMBOLDT COUNTY . . . . .	. 111
INTRODUCTION . . . . .	. 111
STRATIGRAPHY . . . . .	. 111
REFERENCES . . . . .	. 114
STOP 4. TERRACE STRATIGRAPHY AND GEOMORPHOLOGY OF THE OKOBOJI LAKE OUTLET. . . . .	. 115

INTRODUCTION . . . . .	.115
OKOBOJI OUTLET CHANNEL . . . . .	.115
Lower Increment . . . . .	.119
Middle Increment . . . . .	.119
Upper Increment . . . . .	.119
CONCLUSION. . . . .	.119
REFERENCES . . . . .	.125
STOP 5. EXCELSIOR FEN COMPLEX . . . . .	.127
INTRODUCTION . . . . .	.127
DISTRIBUTION AND GEOLOGY OF IOWA FENS . . . . .	.127
PEAT . . . . .	.129
VEGETATION. . . . .	.129
AGE AND DEVELOPMENT OF IOWA FENS . . . . .	.130
HYDROLOGY . . . . .	.131
WATER CHEMISTRY . . . . .	.131
EXCELSIOR FEN . . . . .	.133
REFERENCES . . . . .	.135
STOP 6: MORGAN MEMBER OUTCROP: SWAN LAKE AND CHRISTOPHERSON SLOUGH STATE WILDLIFE MANAGEMENT AREA . . . . .	.137
STOP 7: UNION SLOUGH AND 55 MCGUIRE CORE NEAR BANCROFT . . . . .	.139
UNION SLOUGH . . . . .	.139
55 MCGUIRE CORE. . . . .	.139
STOP 8. GROUNDWATER MONITORING AT AN EARTHEN MANURE- STORAGE STRUCTURE . . . . .	.141
INTRODUCTION . . . . .	.141

LIVESTOCK WASTE HANDLING SYSTEM . . . . .	.141
METHODS. . . . .	.143
HYDROGEOLOGIC SETTING. . . . .	.143
Hydrologic Implications. . . . .	.144
PREVIOUS INVESTIGATIONS OF EMS STRUCTURES AND GROUNDWATER QUALITY . . . . .	.145
WATER-QUALITY RESULTS . . . . .	.147
DISCUSSION . . . . .	.151
REFERENCES . . . . .	.153
<b>STOP 9. AGRICULTURAL DRAINAGE WELLS AND GROUNDWATER QUALITY . . . . .</b>	<b>.155</b>
INTRODUCTION . . . . .	.155
ADWS IN IOWA . . . . .	.156
COUNTY AND LOCAL PERSPECTIVES . . . . .	.157
PREVIOUS INVESTIGATIONS. . . . .	.158
ADWS AND GROUNDWATER QUALITY: A DETAILED LOOK . . . . .	.161
ADWS IN WRIGHT COUNTY. . . . .	.162
MITIGATING THE WATER-QUALITY IMPACT OF ADWS . . . . .	.165
REFERENCES . . . . .	.169

## ACKNOWLEDGEMENTS

We would like to thank the many people involved in the preparation and production of this guidebook. Thanks to the numerous authors who prepared their materials to meet the guidebook publication deadline. They are listed on the guidebook title page and in the section they authored. Thanks to Lynette Seigley for editing numerous sections of this guidebook and to Mary Skopec and Angie Bowman who assisted with the preparation of figures, tables, and proofreading. A special thanks to Bill Bunker (formatting), Pat Lohmann (final publication layout) and the IDNR-Geological Survey Bureau for the production of this guidebook. We would like to thank the field trip stop land owners for their cooperation and interest.



## PREFACE

Stratigraphic, hydrogeologic, and environmental geology studies have been conducted in several areas on the Des Moines Lobe in Iowa during the past two decades. These studies have significantly increased our understanding of the origin of the Lobe's deposits and the relationships among deposits, hydrogeology, and the impacts of land use practices on shallow groundwater in the region. This field trip is designed to give the participants an overview of the Lobe's deposits, the landscapes associated with the deposits, and some of the environmental and land use issues that are facing the region today. The first part of this guidebook provides an introduction to the Lobe's deposits and landforms. Italicized words in this section are defined in the Glossary. The roadlog and stop descriptions that follow provide information on the deposits, landscapes, and environmental geology issues at several locations along the field trip route. The trip crosses all the named glacial ice margins (moraines) and traverses most of the landform categories found on the Lobe in Iowa.





# INTRODUCTION

The distinctive landform region called the Des Moines Lobe formed from a lobate extension of the last great continental glacier. During the Wisconsin Episode, the southern edge of the Laurentide Ice Sheet split into several lobes that each flowed down regional topographic lows. The Des Moines Lobe extended from central Canada through the Dakotas and Minnesota into Iowa, terminating at what is now the city of Des Moines (Figure 1).

Restudy of the Des Moines Lobe has been undertaken for several reasons. From the practical perspective, the Lobe is the most productive agricultural region of the state, and occupies roughly one-fifth of the state's area. Knowledge of the types, properties, and distribution of Des Moines Lobe surficial deposits is needed to make the most economical and most environmentally sound management decisions for agricultural production and farm chemical use. Society's demands for safe landfills, good quality drinking-water supplies, economical road and foundation design, and informed land-use planning also require detailed

knowledge of the Des Moines Lobe's surficial materials. From the scientific perspective, these demands can be met by knowing the type and distribution of glacial and post-glacial landforms on the Des Moines Lobe. The various landforms differ in the type of underlying deposits. Knowledge of the types of landforms present, the sequence of glacial deposits comprising each, and the location of different landform types are what will enable us to predict the environmental consequences of land-use options and therefore help us make wise land-use decisions.

Because of recent scientific advances, the Des Moines Lobe's glacial record can now be better interpreted. Beginning in the 1970s, research at modern glaciers began to provide a more complete understanding of glacial depositional environments, identifying the processes by which glaciers form their distinctive deposits, the variations in glacial processes and environments, and the characteristic sedimentary associations which form. Since the late 1970's, tools such as topographic maps and aerial photographs have enabled better identifica-

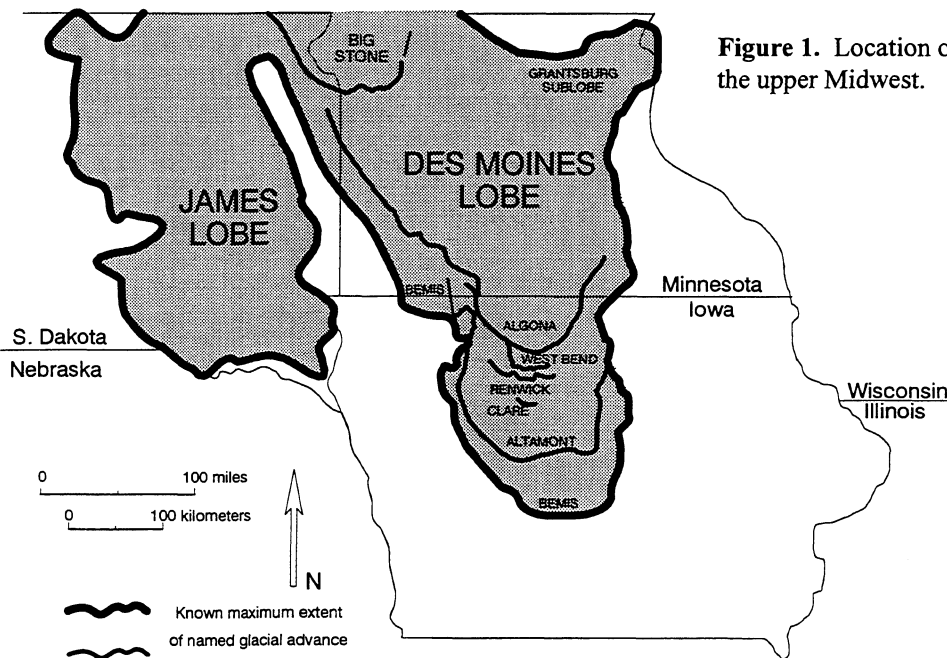


Figure 1. Location of the Des Moines Lobe in the upper Midwest.

tion and mapping of the different kinds of glacial landforms that constitute the Des Moines Lobe. An important part of a reevaluation of the Des Moines Lobe is the development of a *lithostratigraphic* framework for the Lobe's sediments. This stratigraphic framework allows us to better map and understand the surficial materials of the Des Moines Lobe. The second major part of the Lobe's restudy is Kemmis' (1991) remapping of the margins of former glacial advances, which has significantly increased our understanding of the complex landforms and landform assemblages related to those advances. This reevaluation of sedimentary sequences, landforms, and the associations among sedimentary sequences and landforms indicates that the Des Moines Lobe resulted from a special type of glacial behavior known as surging. Surging, consisting of rapid, out-of-equilibrium glacial advance and subsequent stagnation, accounts for the different timing, different types of glacial landforms, and the different depositional sequences of the Des Moines Lobe when compared to other glacial lobes in states to the east.

The age of the Des Moines Lobe is well established by radiocarbon dates (Table 1). The Lobe entered Iowa shortly before 15,000 radiocarbon years before present (RCYBP) and reached the terminal position at Des Moines about 13,800 RCYBP. After reaching its terminus the glacier stagnated. The Lobe readvanced to the position of the Altamont ice margin just north of Ames and Boone about 13,500 years ago (Figure 1), then stagnated. At that time, proglacial meltwater was carried from the central portion of the glacier front by Beaver Creek and the Skunk River (the Des Moines River had not yet originated on the Lobe; Bettis and Hoyer, 1986; Bettis et al., 1988). Between 13,500 and 12,600 RCYBP, there were three minor readvances marked by the Clare, Renwick, and West Bend moraines. The morainic topography associated with these advances is discontinuous, and only the terminal margins are recognized. The final advance into Iowa to the Algona ice margin occurred about 12,300 RCYBP. This advance too, was followed rapidly by stagnation and wastage of the glacier. It was during the Algona advance that the upper Des Moines River,

the major axial drainage of the Lobe, originated (Bettis and Hoyer, 1986; Bettis et al., 1988).

The Des Moines Lobe was active in Iowa between about 15,000 and 12,000 RCYBP, about 5,000 to 8,000 years later than glacial lobes to the east made their southernmost maximum advance (Johnson, 1986; Fullerton, 1986). The Lobe advance occurred well into a period of regional warming and was thus climatically out of equilibrium (Kemmis et al., 1994). Shortly after 12,000 RCYBP the glacier was gone from Iowa and the subsequent history of the Lobe involved subareal development of the drainage network, infilling of depressional areas, and slope evolution under changing climate, vegetation, soil, and shallow groundwater conditions (Walker, 1966; Van Zant, 1979; Kim, 1986; Van Nest and Bettis, 1990; Burras and Scholtes, 1987; Steinwand and Fenton, 1995; Fenton and Steinwand this volume, Stop 1).

An understanding of the thickness of the Dows Formation deposits and the configuration of the sub-Des Moines Lobe surface is important for both applied and scientific interpretations. For example, different substrate deposits may have engineering, hydrogeologic, or geochemical properties that may affect foundation conditions or water quality. Also, the sub-Des Moines Lobe surface is the topography over which the last glacier advanced, and the dynamics of that advance and the resultant depositional regime were affected by the topography.

Present understanding of the sub-Des Moines Lobe (sub-Dows Formation) surface is very rudimentary. In only one small (540 mi<sup>2</sup>) area on its southeastern margin has the thickness of the Lobe been mapped (see Figure 19 in Kemmis et al., 1981). Elsewhere on the Lobe we have yet to assemble and analyze the available outcrop and borehole data that are needed to map the thickness of the Dows Formation and the configuration of the sub-Dows surface. Borehole information is not evenly distributed across the Lobe and the subsurface configuration of many parts of the Lobe is unknown. Nevertheless, a few observations about the sub-Lobe surface and the materials that compose it can be made.

The Des Moines Lobe glacier advanced south-

**Table 1.** Radiocarbon ages from the Des Moines Lobe area, Iowa.

<b>Radiocarbon Samples</b>	<b>Laboratory Number</b>	<b>Location</b>	<b>Materials Analyzed</b>	<b>Notes</b>
<b><i>SAMPLES FROM THE BASE OF THE DOWS FORMATION</i></b>				
12,790±60	CAMS-24957	55 McGuire Core, Kossuth Co.	wood	collected from lower 30 cm of Alden Mbr. above Dows Fm.? proglacial sediments
13,440±230	B-10837	National Gypsum, Ft. Dodge, Webster Co.	macrofossils	collected from organic silts of Sheldon Creek Fm. just below Dows Fm.
13,160±150	B-10835	Saylorville Emergency Spillway, Polk Co.	spruce wood	wood from silty alluvium 0.2m below base of Dows Fm.
13,560±90	B-2749	Saylorville Emergency Spillway, Polk Co.	spruce wood	log from base of Dows Fm.
13,800±245	various A-	Saylorville Emergency Spillway, Polk Co.	spruce wood rooted in alluvium	average age of 12 determinations on six different logs -- all 5000 second counts
13,900±400	I-1268	Stratford, Hamilton Co.	wood	at depth of 19.7m in Dows Fm. just above contact with stratified silts and sands
13,910±400	WIS-517	Scranton, Green Co.	wood	tree rooted in place in Peoria Fm. loess
13,930±130	CAMS-17387	National Gypsum, Ft. Dodge, Webster Co.	beetle chitin	collected from organic silts of Sheldon Creek Fm. 10-20 cm below Dows Fm.; same location as B-10838
14,042±1000	C-664	Cook's Quarry near Ames, Story Co.	hemlock wood	log from sand and gravel just below Dows Fm.; age determined by carbon-black method
14,200±500	I-1402	Nevada, Story Co.	wood	spruce wood from upper increment of Peoria Fm. loess
14,380±180	I-9765	Weaver Quarry near Alden, Hardin Co.	larch wood	log from contact of Dows Fm. and paleosol in Peoria Fm. loess
14,410±240	B-9877	National Gypsum, Ft. Dodge, Webster Co.	macrofossils	collected from organic silts of Sheldon Creek Fm. just below Dows Fm.
14,470±400	WIS-512	Scranton, Green Co.	spruce wood	wood from top of Peoria Fm. loess; see W-513
14,840±160	CAMS-17383	National Gypsum, Ft. Dodge, Webster Co.	beetle chitin	collected from organic silts of Sheldon Creek Fm. just below Dows Fm.; same location as B-10837
15,140±220	B-9797	National Gypsum, Ft. Dodge, Webster Co.	macrofossils	collected from organic silts of Sheldon Creek Fm. just below Dows Fm.
15,310±180	B-10838	National Gypsum, Ft. Dodge, Webster Co.	wood	collected from organic silts of Sheldon Creek Fm. 10-20 cm below Dows Fm.

Table 1. contd.

Radiocarbon Samples	Laboratory Number	Location	Materials Analyzed	Notes
<b><i>SAMPLES FROM WITHIN THE DOWS FORMATION</i></b>				
11,740±100	DIC-1361	Algona, Kossuth Co.	spruce wood	log in Alden Mbr. of Dows Fm. at depth of 10m below modern land surface
11,952±500	C-596	Cook's Quarry near Ames, Story Co.	hemlock wood	log 1m above base of Dows Fm.; age determined by carbon-black method
12,220±500	C-653	Cook's Quarry near Ames, Story Co.	hemlock wood	log 1m above base of Dows Fm.; age determined by carbon-black method
12,610±250	ISGS-641	Algona, Kossuth Co.	spruce wood	log in Alden Mbr. of Dows Fm. at depth of 10m below modern land surface; same log as Dic-1361
12,750±130	B-8356	Core OKCT PW5, Winnebago Co.	macrofossils	reported by Graeff (1986) as occurring in sandy Holocene alluvium, but reinterpreted here as occurring in Morgan Mbr. of Dows Fm. in linked-depression system
13,020±90	B-9876	clay pit near Lehigh, Webster Co.	spruce wood	2.1m above base of Dows Fm. in Alden Mbr.
13,400±130	DIC-1651	quarry near Dows, Franklin Co.	spruce wood	0.7m above base of Dows Fm. in Alden Mbr.; from same horizon as B-1076
13,500±130	B-9796	clay pit near Lehigh, Webster Co.	spruce wood	1.7m above base of Dows Fm. in Alden Mbr.
13,525±95	B-1076	quarry near Dows, Franklin Co.	spruce wood	0.7m above base of Dows Fm. in Alden Mbr.; average of two analyses; from same horizon as Dic-1651
13,525±95		quarry near Dows, Franklin Co.	spruce wood	1.2m above base of Dows Fm. in Alden Mbr.
13,680±80	ISGS-552	Cook's Quarry near Ames, Story Co.	spruce wood	1.0m above base of Dows Fm. in Alden Mbr.; see carbon-black dates from same locality (C-596, 653, 664)
<b><i>SAMPLES FROM OUTWASH (NOAH CREEK FORMATION)</i></b>				
12,000±105	DIC-1362	Whittemore, Kossuth Co.	spruce wood	log from peat and forest bed from outwash associated with the Algona ice margin
12,020±70	I-8768	Whittemore, Kossuth Co.	spruce wood	tree stump rooted in place in peat on outwash associated with Algona ice margin
12,160±80	B-2632	below Saylorville Dam, Polk Co.	spruce wood	log from base of outwash
12,920±250	WIS-626	Britt, Hancock Co.	larch wood	tree stump rooted in place in outwash associated with Algona ice margin
13,030±250	WIS-625	Britt, Hancock Co.	peat	peat from buried soil in outwash below sample W-626

Table 1. contd.

Radiocarbon Samples	Laboratory Number	Location	Materials Analyzed	Notes
<i>SAMPLES FROM DEPOSITS BELOW THE DOWS FORMATION</i>				
12,120±530	C-912	Lizard Creek, Webster Co.	hemlock wood	wood from sand and gravel below Dows Fm., C-913 from same horizon; age determined by carbon-black method
13,300±900	C-913	Lizard Creek, Webster Co.	hemlock wood	wood from sand and gravel below Dows Fm., from same horizon as C-912; age determined by carbon-black method
13,820±400	WIS-513	Scranton, Green Co.	spruce wood	within Peoria Fm. loess, 4.9m below contact with Dows Fm.; see W-512
14,570±140	B-10524	Saylorville Emergency Spillway, Polk Co.	spruce wood	0.8m below base of Dows Fm. in silty alluvium
14,700±400	OWU-153	Clear Creek, Story Co.	hemlock wood	within Peoria Fm. loess, 5.2m below contact with Dows Fm.
15,290±110	B-10836	Saylorville Emergency Spillway, Polk Co.	spruce wood	2.3m below base of Dows Fm. in silty alluvium
15,775±145	B-4807	Ledges State Park, Boone Co.	spruce wood	in Peoria Fm. loess, 2.1m below base of Dows Fm.
16,100±1000	I-1270	road cut on west side of Des Moines Valley west of Boone, Boone Co.	spruce wood	within Peoria Fm. loess, 0.7m below base of Dows Fm.
16,100±500	I-1024	Madrid, Polk Co.	spruce wood	within Peoria Fm. loess, 0.6m below contact with Dows Fm.
16,367±1000	C-528	Clear Creek, Story Co.	hemlock wood	within Peoria Fm. loess, 5.2m below base of Dows Fm., see C-481; age determined by carbon-black method
16,720±500	WIS-126	Mitchellville, Polk Co.	spruce wood	wood within Peoria Fm. loess, 4.3m below base of Dows Fm.
16,980±180	B-10525	Saylorville Emergency Spillway, Polk Co.	spruce wood	4.0m below base of Dows Fm. in silty alluvium
17,000	C-481	Mitchellville, Polk Co.	spruce wood	wood within Peoria Fm. loess, 4.3m below base of Dows Fm.; age determined by carbon-black method

Table 1. contd.

Radiocarbon Samples	Laboratory Number	Location	Materials Analyzed	Notes
<i>BASAL FEN, MARSH AND LAKE SAMPLES</i>				
9,300±130	B-12343	Pilot Mound Pollen Site, Boone Co.	organic silt	unknown distance above top of Dows Fm.
10,370±140	B-30374	Clear Lake, Cerro Gordo Co.	organic sediment	1.25m above Dows Fm.
11,530±170	I-3145	Woden "Bog," Hancock Co.	larch wood	0.3m above top of Dows Fm.
11,635±400	I-1019	Jewell "Bog," Hamilton Co.	organic silt	at contact with Dows Fm.
12,430±160	B-3049	Zuehl Farm Pollen Site	organic silt	0.9m above top of Dows Fm.
13,775±300	I-1015	Colo "Bog," Story Co.	muck	2.4m above top of Dows Fm.
13,990±135	WIS-835	Little Millers Bay Core, West Okoboji Lake, Dickinson Co.	organic silt	0.5m above top of Dows Fm.
14,500±340	I-1414	McCulloch "Bog," Hancock Co.	muck	1.2m above top of Dows Fm.

ward along the regional slope, particularly on the east and southeast side of the Lobe. This is indicated by the fact that the pre-existing major stream valleys all flow to the southeast, directly away from the Lobe, with no major changes in ice-marginal drainage patterns. On the west and southwest margins, however, major drainage derangements (Hoyer, 1980) and peripheral ice-marginal drainage patterns are evident, indicating that the ice was flowing against the regional slope, onto the Prairie Coteau in South Dakota and Minnesota and in Iowa onto its southern extension, the Mississippi-Missouri divide.

Figure 2 shows the thickness of Quaternary deposits in the Des Moines Lobe region. The Dows Formation deposits of the Lobe are not differentiated from older Quaternary deposits on this map. Several limited areas where bedrock is within 25 feet of the land surface are evident (Dows Formation deposits probably rest on the bedrock surface in these areas), as are areas such as in the northwestern part of the Lobe in Iowa, where more than 150 feet of Quaternary section is present. The southern part of the Lobe (areas beyond the Altamont ice margin) is underlain by Peoria Formation loess, and a progressive increase in the silt content of Dows Formation *diamicton* to the south reflects incorporation of the loess substrate. In many of the localities where the Lobe has been penetrated, however, the Dows/sub-Dows contact shows little evidence for significant erosion, and is marked by either a paleosol or uneroded proglacial alluvial/lacustrine deposits. These contact relationships suggest a "warm bedded" glacier at the pressure melting point, rather than one frozen to the bed (Sugden and John, 1976).

### STRATIGRAPHIC FRAMEWORK FOR THE DES MOINES LOBE

We have devised a lithostratigraphic framework for the surficial deposits of the Des Moines Lobe that groups sediments according to properties that are easily observed in the field or in core samples. This framework is useful for both scientific purposes, such as stratigraphic classification, as well as for practical purposes, such as

hydrogeologic and engineering studies.

Surficial deposits of the Des Moines Lobe are grouped into four formations: the Dows, Noah Creek, Peoria, and DeForest formations. The Dows Formation consists of upland glacial deposits. The Noah Creek Formation is composed predominantly of coarse-grained *glaciofluvial* and *fluvial* deposits in stream valleys and on outwash plains. The Peoria Formation consists primarily of *loess* beneath the southern part of the Des Moines Lobe, and *olian sand* locally blanketing the surface of the Lobe. The DeForest Formation includes post-glacial sediments that are primarily fine-grained *alluvial*, *colluvial*, and *paludal* deposits. The Dows and DeForest formations are further subdivided into lithologically different members.

### DOWS FORMATION

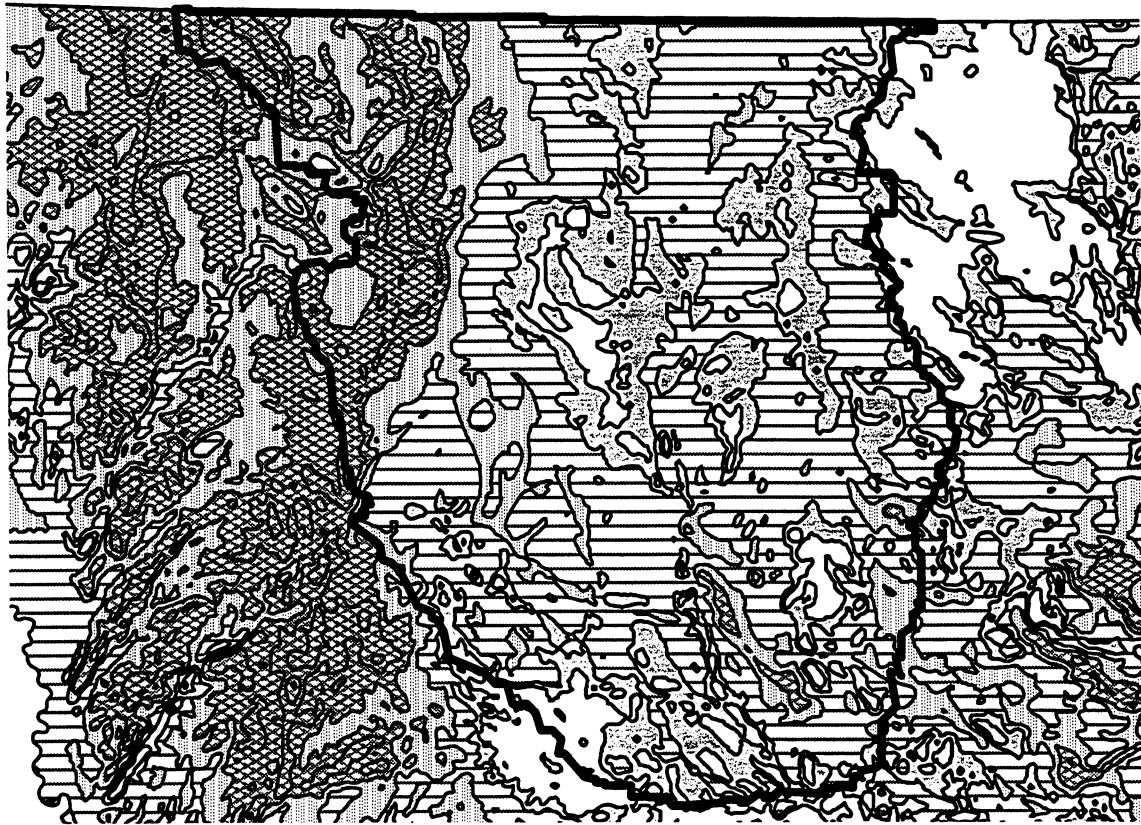
The Dows Formation includes all upland glacial deposits on the Des Moines Lobe. The formation is subdivided into four different members: the Alden, Morgan, Lake Mills, and Pilot Knob members. Information on the formation as a whole is presented first, followed by that for individual members.

**Source of name:** the town of Dows, Franklin County, Iowa.

**Type Section:** the Martin-Marietta quarry located in the NW 1/4, NE 1/4, SE 1/4 of section 30, T. 91 N., R. 22 W., Franklin County, Iowa (Kemmis et al., 1981). The type section is located on the flanks of the high-relief Altamont glacial-ice margin complex.

**Description of Unit:** The Dows Formation includes all upland *glacigenic* deposits on the Des Moines Lobe in north-central Iowa. It is subdivided into four members. The Alden Member consists predominantly of massive, dense, compositionally uniform diamicton. The Morgan Member consists of diamictons interbedded with generally thin, discontinuous beds of sorted sands, silts, silty clays, and gravels. The Lake Mills Member consists predominantly of massive to laminated silts and silty clays, frequently with a thin basal zone of sand and gravel. The Pilot Knob Member





0 50 100 Miles

— Des Moines Lobe Boundary

Quaternary Thickness

□ 0 - 25 feet

▨ 26 - 75 feet

▧ 76 - 150 feet

▩ 151 - 250 feet

▪ 251 - 650 feet



**Figure 2.** Thickness of Quaternary deposits in the Des Moines Lobe landform region of Iowa.

consists predominantly of upland sands and gravels occasionally interbedded with thin, discontinuous diamicton beds. At the type section, the Dows Formation consists of deposits of the Alden Member overlain by the Morgan Member (Kemmis et al., 1981).

**Nature of Contacts:** The Dows Formation unconformably overlies various older stratigraphic units including proglacial sand and gravel deposited during lobe advances, Peoria Formation loess, older Wisconsinan glacial deposits of the Sheldon Creek Formation, diamictons of the Pre-Illinoian-age Wolf Creek and Alburnett formations, buried soils developed in diamictons of the Pre-Illinoian Wolf Creek and Alburnett formations or undifferentiated alluvial and colluvial deposits overlying these formations, Cretaceous-age shale, various Pennsylvanian-age sedimentary rocks, and Mississippian- and Devonian-age carbonate rocks. The formation usually overlies Quaternary sediments. It rests on Cretaceous-, Pennsylvanian-, Mississippian-, and Devonian-age bedrock in only small, restricted areas.

The formation is at the surface over most of north-central Iowa, except on outwash plains where it is buried by sand and gravel of the Noah Creek Formation. Locally the Dows Formation is overlain by younger colluvial, alluvial, or paludal sediment of the DeForest Formation. In stream valleys, the Noah Creek and DeForest formations are often incised through the formation.

**Differentiation from other Units:** The Dows Formation is distinguished by its distinctive clay mineralogy (Table 2). Compared to other formations, the massive diamicton is higher in expandable clay minerals (smectite group) and, unlike other northern-source glacial formations (Sheldon Creek, Wolf Creek, and Alburnett formations), the illite percentages are higher than the kaolinite-plus-chlorite percentages.

The distinctive clay mineralogy of the Dows Formation is similar to the clay mineralogy of Cretaceous-age Pierre Shale, a distinctive bedrock lithology that was glacially eroded and incorporated into the Dows Formation. The clay-mineral composition of fifteen Pierre Shale fragments taken from the Dows Formation is 67±3% expandables,

27±3% illite, and 6±2% kaolinite plus chlorite (Kemmis et al., 1981). This compares with the clay mineralogy of the fine-grained matrix of massive Dows Formation diamictons of 69±4% expandables, 19±3% illite, and 12±3% kaolinite plus chlorite (Table 2).

**Regional Extent and Thickness:** The Dows Formation is continuous across uplands on the Des Moines Lobe in Iowa. Formation and member thicknesses vary. The formation is typically 15 to 20 m (45 to 60 ft) thick across most of the Lobe. It thickens to over 30 m in ridges and escarpments deposited at the edge of former ice advances (“end moraines”). Stream valleys are cut into or through the upland Dows Formation deposits; the lower reaches of most major streams, such as the Des Moines, Iowa, Raccoon, and Boone rivers, have incised completely through the Dows Formation sequence at many sites.

**Origin:** The Dows Formation includes all upland glacial deposits on the Des Moines Lobe. Members of the formation are distinguished by their characteristic lithologic properties (see member discussions below). Although these properties are not defined by the origin of the deposits, the members are usually associated with distinctive glacial environments. The massive diamicton of the Alden Member is usually *till* that has been deposited in a *subglacial* environment. The interbedded diamicton and sorted deposits of the Morgan Member were usually deposited in *ice-marginal* and *supraglacial* settings. The fine-grained, generally pebble-free deposits of the Lake Mills Member usually were deposited in glacial lakes. The coarse-grained, sand-and-gravel deposits of the Pilot Knob Member are found in the core of *kame* and *esker* landforms deposited in association with glacial meltwater.

**Age and Correlation:** The Dows Formation was deposited by advances of the Des Moines Lobe dating from approximately 15,000 to 12,000 radiocarbon years before present (Kemmis et al., 1981; Ruhe, 1969). The formation is correlative to the New Ulm Till of Minnesota (Hallberg and Kemmis, 1986) for which Matsch (1972) provides limited textural and compositional data.

**Table 2.** Clay mineralogy of massive glacial diamictos in Iowa (data from Kemmis et al., 1981; Hallberg, 1980; Hallberg et al., 1980; Van Zant, 1973).

<b>Formation</b>		<b>Ex.</b> mean $\pm$ s.d.	<b>Ill.</b> mean $\pm$ s.d.	<b>K+C</b> <sup>1</sup> mean $\pm$ s.d.
Dows Formation				
Alden Mbr.	n=94	69 $\pm$ 4	19 $\pm$ 3	12 $\pm$ 3
Sheldon Creek Fm. <sup>2</sup>	n=6	65 $\pm$ 3.5	18 $\pm$ 1.8	18 $\pm$ 1.8
Glasford Formation	n=150	46 $\pm$ 7.6	34 $\pm$ 6.3	20 $\pm$ 3.5
Wolf Creek Formation				
Hickory Hills Till Mbr.	n=101	63 $\pm$ 4.5	17 $\pm$ 3.3	20 $\pm$ 2.2
Aurora Till Mbr.	n=82	62 $\pm$ 3.6	18 $\pm$ 2.5	21 $\pm$ 2.3
Winthrop Till Mbr.	n=24	60 $\pm$ 4.3	17 $\pm$ 2.2	24 $\pm$ 3.8
Alburnett Formation	n=163	43 $\pm$ 5.6	25 $\pm$ 4.1	30 $\pm$ 3.9

<sup>1</sup> Ex.--expandable clay minerals (smectite group); Ill.--illite; K+C--kaolinite and chlorite

<sup>2</sup> formerly referred to as 'Tazewell till'

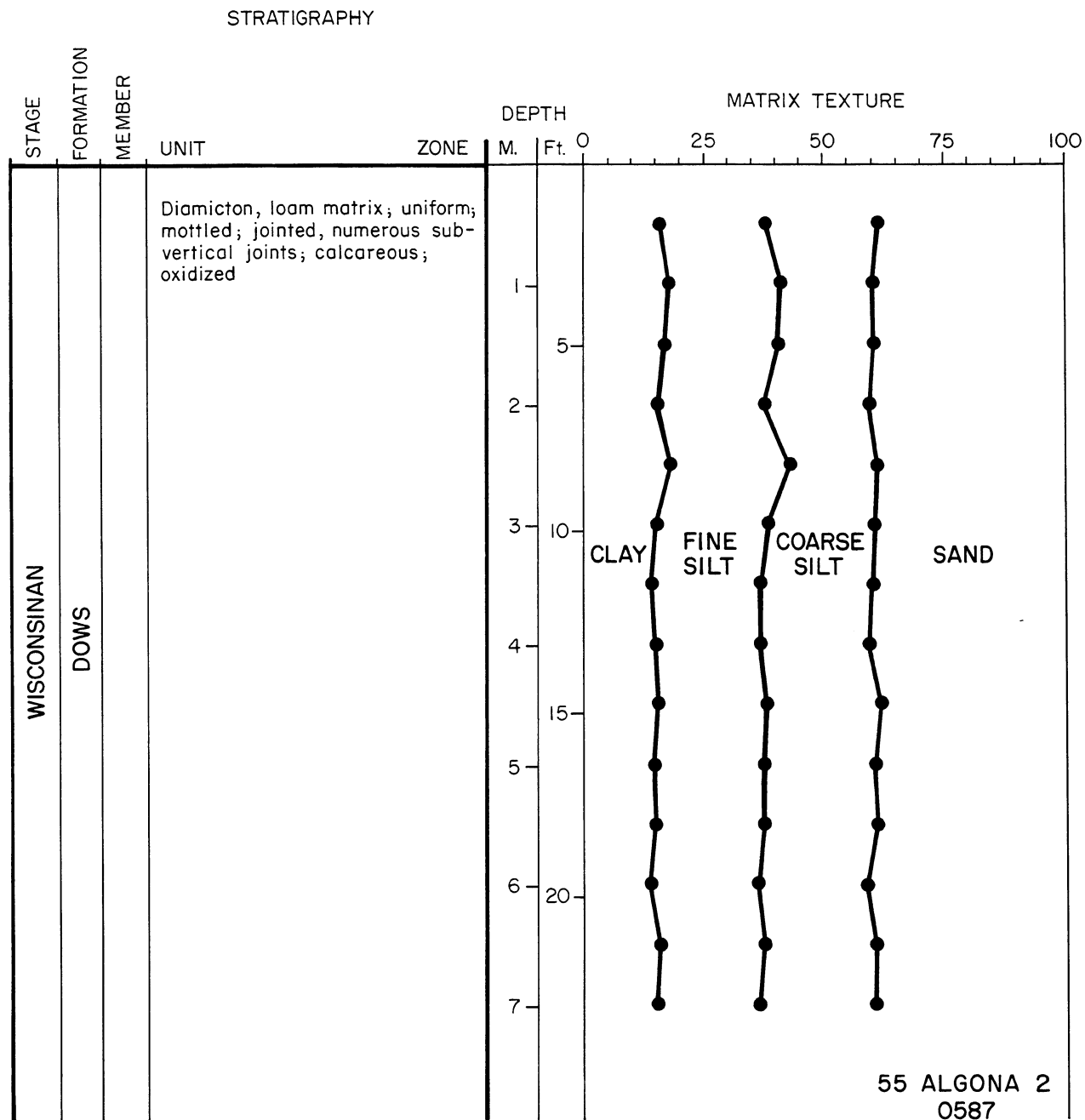
### Alden Member

**Source of name:** the town of Alden, Iowa, near which Alden Member deposits are well exposed in the Martin-Marietta quarry located just southeast of town in the NE 1/4, NW 1/4, NE 1/4 of section 20, T. 89 N., R. 21 W., Hardin County, Iowa.

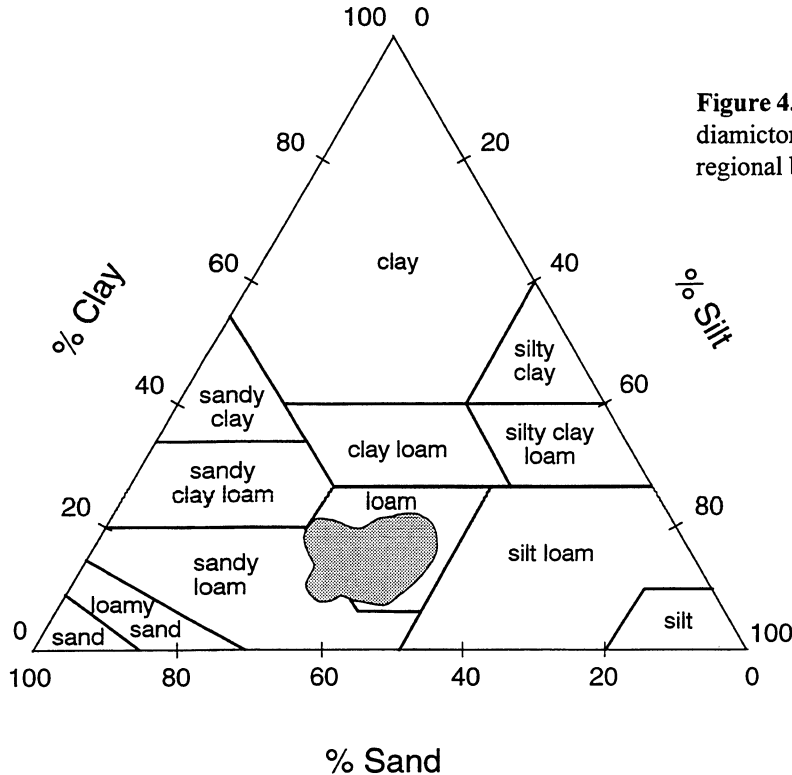
**Type Section:** same as that of the Dows Formation; the Martin-Marietta quarry located in the NW 1/4, NE 1/4, SE 1/4 of section 30, T. 91 N., R. 22 W., Franklin County, Iowa.

**Description of the Unit:** The bulk of the Alden Member consists of massive, compositionally uniform diamicton. The diamicton is matrix-dominated, with the sand-silt-clay matrix typically comprising 94 to 96% of the diamicton by weight. The matrix texture tends to be uniform both with depth at any one site (Figure 3) and regionally from site to site (Figure 4). Several exceptions to this

textural uniformity occur locally. At the base of the unit, the texture may vary because of incorporation of local substrate material. Discontinuous pods and lenses of sorted deposits (usually pebbly sands, sands, pebble gravels and silts) are also common at the base of the diamicton. In some cases, block inclusions of intact local substrate occur in the diamicton, but these are rare. Smudges, inclusions of local substrate that have been smeared out in or at the base of the glacier (Kruger, 1979), are also rare. The matrix texture of the diamicton is loam across the Lobe, although there is local variation within the range of sand-silt-clay percentages that comprise the loam textural group. The only systematic variation observed to date occurs south from the latitude of Ames where loess becomes the dominant substrate material below the Dows Formation. Glacial erosion of the loess and its incorporation into the Alden Member



**Figure 3.** Stratigraphy and particle-size data for the 55 Algona-2 section, located on the proximal side of the escarpment crest along the southern Algona margin (SE 1/4, SW 1/4, SE 1/4 of section 10, T. 95 N., R. 29 W., Kossuth County, Iowa). The figure shows the uniform matrix texture with depth that is characteristic of the Alden Member of the Dows Formation. From Kemmis et al. (1981).



**Figure 4.** The matrix texture of Alden Member diamictons is loam, showing little variation on a regional basis. From Kemmis et al. (1981).

diamicton matrix has resulted in a systematic increase in the silt content of the diamicton downglacier to the terminus in Des Moines.

Rod-shaped (prolate) pebbles in the massive diamicton are usually strongly and consistently oriented. The orientations of prolate pebbles in the Alden Member (Figure 5) are oriented parallel to the glacial flow direction inferred from ice-margin orientations, and are interpreted to have been oriented by a pervasive subglacial stress field at the base of an actively moving glacier. Pebble fabrics measured in massive Alden Member diamicton from around the Des Moines Lobe are well oriented and show similar consistency between measurement sites at a given location.

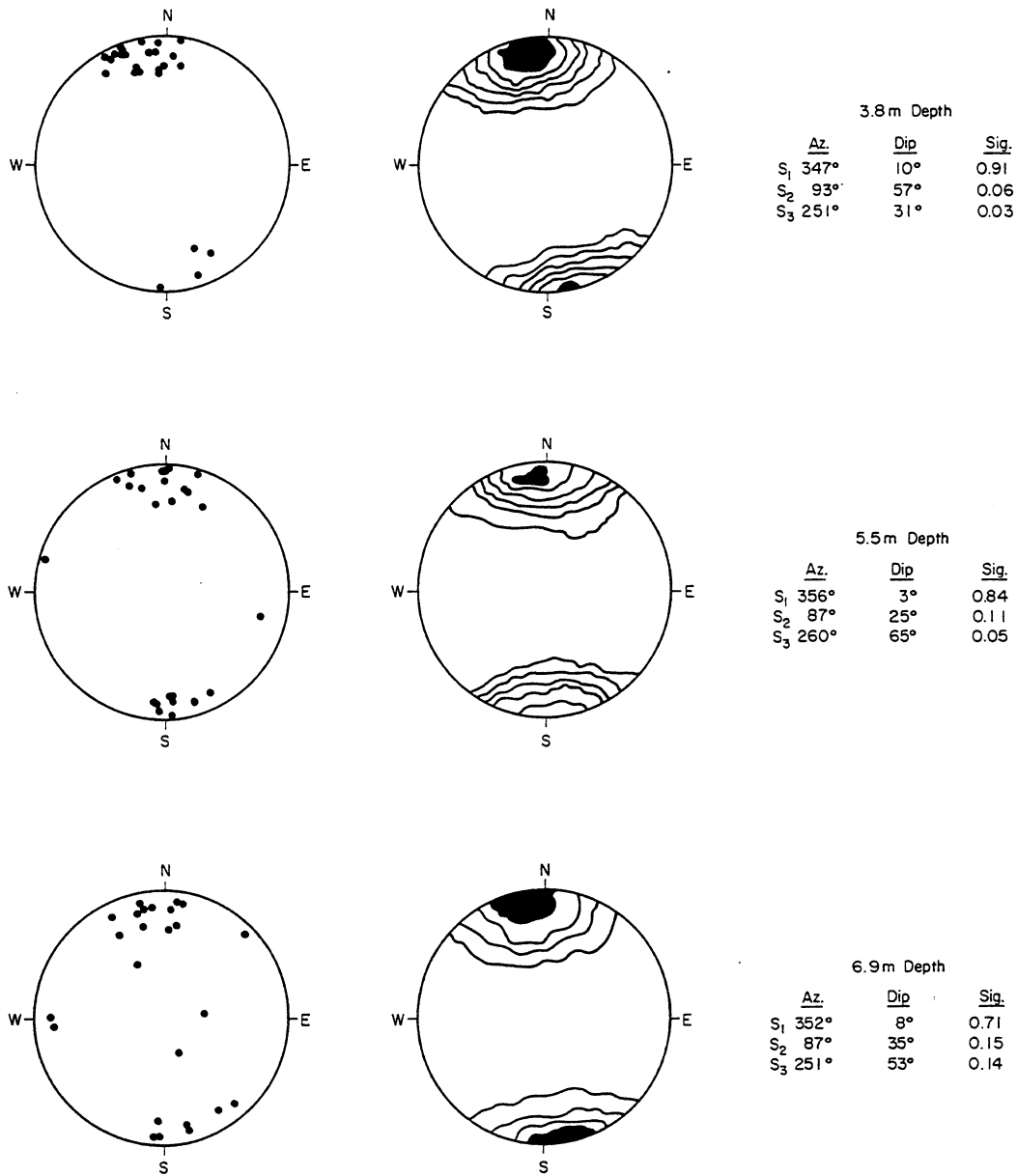
Massive diamicton of the Alden Member is usually dense (Figure 6) and “overconsolidated” (compacted to greater densities than possible just by the stress, or weight, of overlying deposits). Densities vary little and have a mean of about 1.9 g/cc. Where unweathered, Alden Member diamicton is unoxidized, very dark gray, and unleached. Various secondary pedogenic and weathering changes

may have altered the deposits, depending on the local relief, vegetation, and geomorphic history.

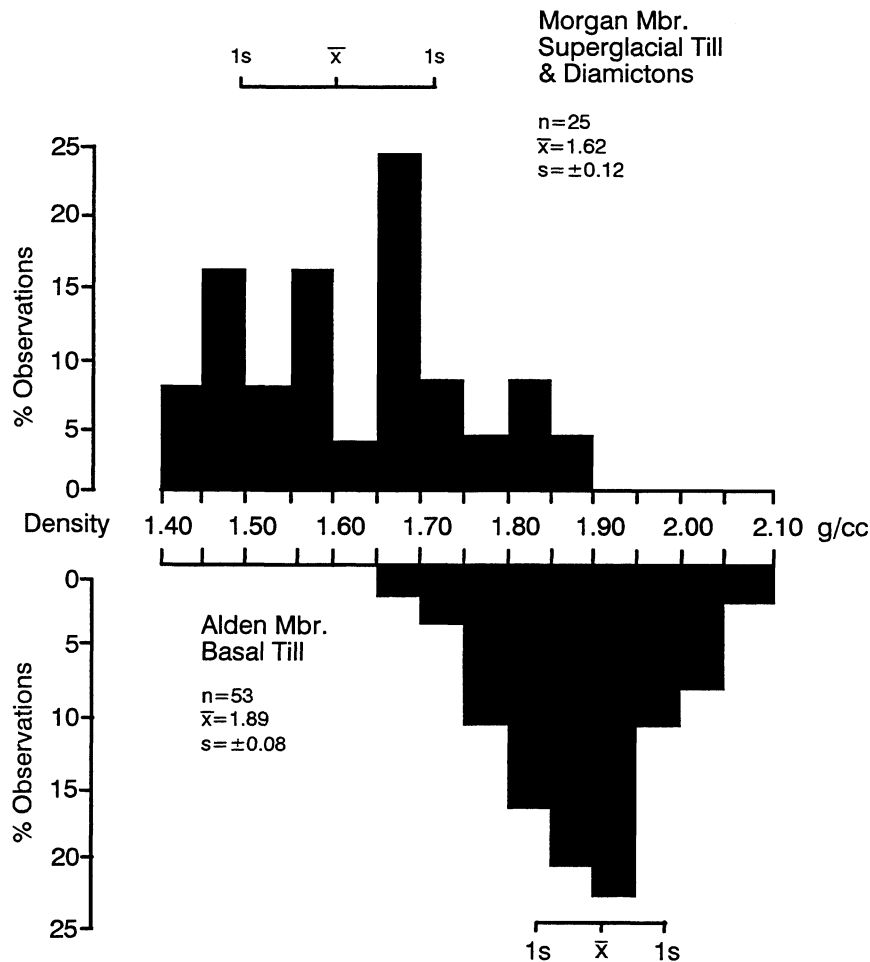
**Nature of Contacts:** The Alden Member abruptly overlies various older Quaternary deposits or bedrock. The basal contact is abrupt and almost always planar with little undulation, but in restricted local areas the contact is deformed. Clasts at the basal contact are sometimes embedded (‘lodged’) in the underlying substrate. Clark (1991) stated there was a fairly continuous *striated clast pavement* beneath the Des Moines Lobe in Iowa, although no specific data were given. Such a striated clast pavement is very rare and restricted in occurrence. Out of forty-two sites we have described in detail, only two have a striated clast pavement, while two others have clasts concentrated at the basal contact but no clast “pavement,” as such.

The basal contact sometimes appears to be *conformable*, but usually is erosional to various degrees. The tendency toward a flat, planar bed has resulted in differential erosion where the higher, better drained paleolandscape positions have usu-

55 ALGONA - 2  
 PEBBLE FABRICS - BASAL TILL  
 Contour Interval =  $2 \sigma$   
 Ice Flow Direction Based on Moraine Orientation: From North  
 n=25



**Figure 5.** Lower-hemisphere scatter plots and contoured equal-area nets for pebble fabrics in uniform, massive diamicton of the Alden Member at the 55 Algona-2 section. Numbers at the top of each data set refer to sample locations. The azimuth, dip, and significance values are given for eigenvectors  $s_1$  (direction of maximum clustering),  $s_2$ , and  $s_3$  (direction of minimum clustering). These plots show strongly oriented pebble fabrics dipping upglacier to the northwest, parallel to the glacial flow direction inferred from ice-margin orientations. These pebbles are interpreted to have been oriented by a pervasive subglacial stress field at the base of an actively moving glacier. From Kemmis (1991).



**Figure 6.** Bulk density data for the Morgan and Alden members of the Dows Formation. From Kemmis et al. (1981).

ally been eroded away, while the more poorly drained positions (and their associated *paleosols*) are commonly preserved beneath the Alden Member.

The substrate underlying the Alden Member is almost always overconsolidated (compacted), the deformation resulting in a reduction of pore space, the expulsion of pore water, and an increase in density. Table 3 shows density values of Alden Member diamicton overlying Peoria Formation loess. Here the uppermost loess has been compacted to a density like that of the overlying Alden Member diamicton, while at depth the loess density resembles that which was never overridden by a glacier. This relationship where loess (or other

sediment type) has a higher density at the contact with the overlying Alden Member than with depth, is common.

Other deformation of the substrate appears to be minimal. Where *paleosols* are preserved beneath the Alden Member contact, even small-scale features like soil horizons and soil structure (measured in centimeters and millimeters) are preserved. Local shear displacements of the underlying deposits (such as low-angle thrust faults) are occasionally observed, but displacements are usually a few tens of centimeters (1-3 ft) to a few meters (10 ft or less) in length, and these features are not common.

The upper contact varies. In places, the Alden

Member is at the surface. Where buried by the interbedded diamictos and sorted deposits of the Morgan Member, the contact may vary from gradational to abrupt. Contacts with overlying Lake Mills and Pilot Knob members, and the Noah Creek and Peoria formations are always abrupt. Contacts with overlying sediments of the DeForest Formation are marked by a discontinuous to distinct stone line or a basal zone of coarse sand.

**Differentiation from Other Members:** The Alden Member differs from other members of the formation primarily in texture and bedding structures. The generally thick, massive diamicton of the Alden Member contrasts with the diamicton of the Morgan Member which usually occurs as beds with sorted sands, silts, and pebbly sands. Diamicton beds in the Morgan Member are usually massive too, but sometimes include various sedimentary structures that indicate resedimentation (detailed in the following section on the Morgan Member). In addition, unlike for the bedded sequence of the Morgan Member, Alden Member diamicton usually shows no evidence for collapse from deposition on or next to stagnant ice.

Diamicton of the Alden Member contrasts with the well sorted fine-grained and sandy deposits of the Lake Mills Member, and the coarse, well to poorly sorted gravels and sands of the Pilot Knob Member.

**Extent and Thickness:** The Alden Member is the thickest and most extensive member of the formation, underlying nearly all upland sites on the Des Moines Lobe. Thicknesses vary depending on the landform type and topographic position. Typically, massive diamicton of the Alden Member ranges from 10 to 20 m (30 to 60 ft) in thickness. However, near the southern Des Moines Lobe terminus, thicknesses typically range from 4 to 6 m (13 to 20 ft); whereas at or near former ice margins, thicknesses can approach 30 m (100 ft).

**Origin:** The Alden Member was deposited by various advances of the Des Moines Lobe into Iowa. Its typical lithologic properties (massive structure, poor sorting, overconsolidation, high density, and strongly oriented pebble fabrics) suggest the Alden Member diamicton is usually till formed subglacially by *lodgement*, *melt-out*, or *deformation*.

**Table 3.** Density of Alden Member diamicton overlying Peoria Loess at the 77 COM site in Des Moines, Polk County, Iowa. The bulk density of loess immediately below the Alden Member contact is similar to that of the diamicton.

Depth	Bulk Density	Stratigraphic Unit
1.5 m	1.68 g/cc	Alden Member diamicton
3.0 m	1.70 g/cc	Alden Member diamicton
4.5 m	1.68 g/cc	Peoria Fm. loess
6.0 m	1.47 g/cc <sup>1</sup>	Peoria Fm. loess
7.5 m	1.49 g/cc	Peoria Fm. loess
9.0 m	1.47 g/cc	Peoria Fm. loess
10.5 m	1.38 g/cc	Peoria Fm. loess

<sup>1</sup> a typical bulk density for C horizon Peoria Fm. not overridden by glaciers is 1.49 g/cc

## Morgan Member

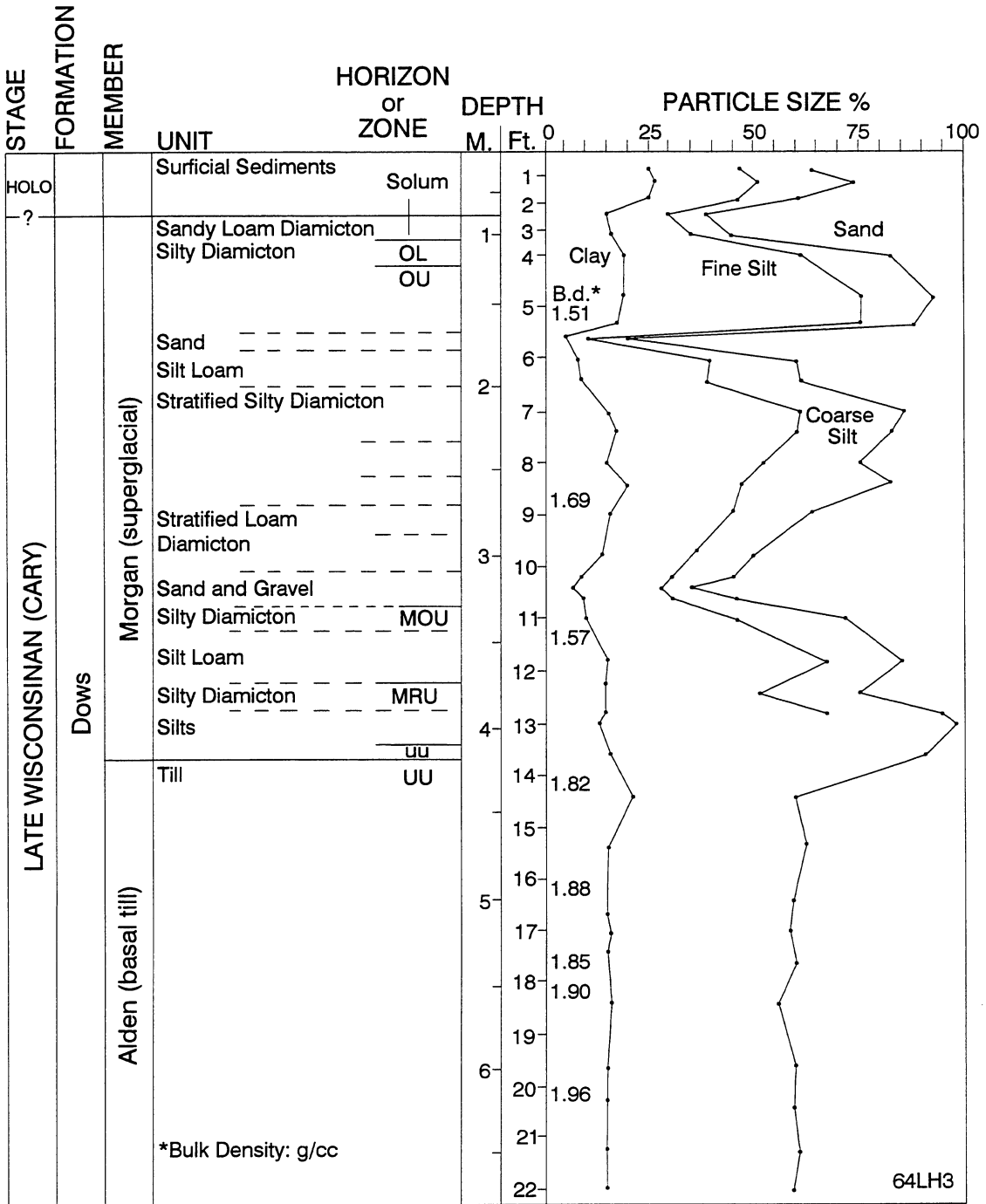
**Source of name:** Morgan Township, Franklin County, the township in which the type section for the Dows Formation is located.

**Type Section:** same as that for the Dows Formation: the Martin-Marietta quarry located in the NW 1/4, NE 1/4, SE 1/4 of section 30, T. 91 N., R. 22 W., Franklin County, Iowa.

**Description of the Unit:** The Morgan Member consists of interbedded diamicton and sorted sediment. Diamicton beds in this sequence are distinctive. Most are massive, some have basal gravel layers, and others become finer grained upward although these 'normally graded' beds are rare. Matrix textures often fall in the loam category (Figure 7), but there can be variation both within beds and between beds. Individual beds sometimes contain small clasts of sorted sediment, and some beds grade upward to laminae or thin beds of sorted sediment. Overall, there is greater variation in matrix texture for the diamicton beds of the Morgan Member compared to the thick, massive diamictos of the Alden Member (Figure 8). Bulk densities of diamicton beds in the Morgan Member vary and tend to be lower than those of the massive



# STRATIGRAPHY



**Figure 7.** Stratigraphy, particle-size and bulk density data for core site 64 LH-3, located just west of the Bemis lateral moraine in a moderate relief, hummocky ridge landform area (just west of Marshall/Story County line, SE 1/4 of section 12, T. 83 N., R. 21 W., Story County, Iowa).

diamicton comprising the Alden Member (Figure 6).

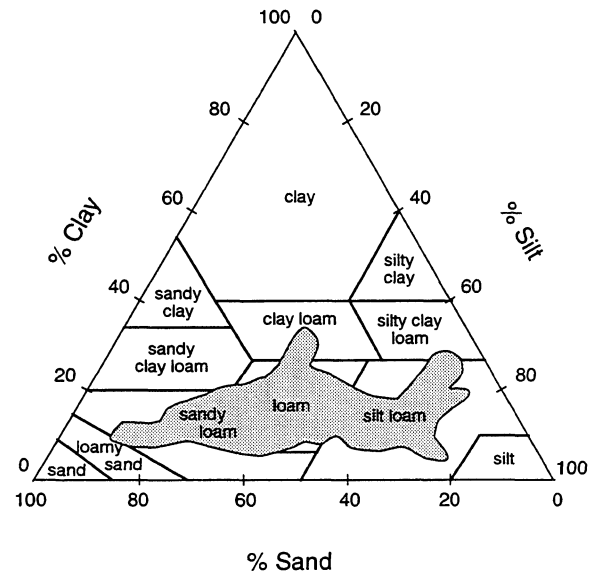
Diamicton beds in the Morgan Member vary from 1 centimeter to as much as 2 meters (1/4 inch to 6 ft) in thickness, but most beds are less than 0.7 m (2.5 ft) thick. The beds are discontinuous, occurring either in sheets or pods. From two-dimensional exposures it is difficult to tell the exact extent of these sheets and pods, but individual sheets often extend for several meters, perhaps as much as 15 m (40 to 50 ft). Diamicton pods are less extensive, and commonly range from 0.5 to 5 m (2 to 15 ft) in extent.

Rod-shaped (prolate) pebbles in the diamicton beds are usually not strongly or consistently oriented. Even within an individual bed, orientations may diverge (Figure 9).

Contacts between adjacent diamicton beds may be gradational or abrupt, whereas contacts between diamicton beds and beds of sorted sediment are usually abrupt. These contacts are commonly deformed, resembling soft-sediment deformation (Lowe, 1978) that occurs when sediment strength is locally exceeded by increasing weight as overlying sediment successively accumulates.

Sorted sediments in the Morgan Member include a wide range of textures. The fine-grained deposits are usually pebble-free, and include loam, silt loam, clay loam, silty clay loam, and silty clay textures. Coarser-grained deposits include sands, pebbly sands (matrix-supported pebble gravels), and well sorted (clast-supported) pebble gravels. Clasts larger than coarse pebbles are infrequent in the sorted sediments.

The sorted sediments occur in a wide variety of bedding structures, including laminae, massive beds, plane beds, ripple-drift cross-lamination, cross-bed sets, inversely and normally graded beds, and channel fills [(both small-scale individual fills and large-scale fills composed of multiple beds and sedimentary structures—the multi-storey type fills described by Ramos and Sopena (1983)]. Individual beds are usually thin, ranging from lamina to beds 0.5 m (1/10 in. to 1.5 ft) in thickness. The beds occur as sheets or as part of channel fills. Individual sheets are discontinuous. From two-dimensional exposures it is difficult to tell how far



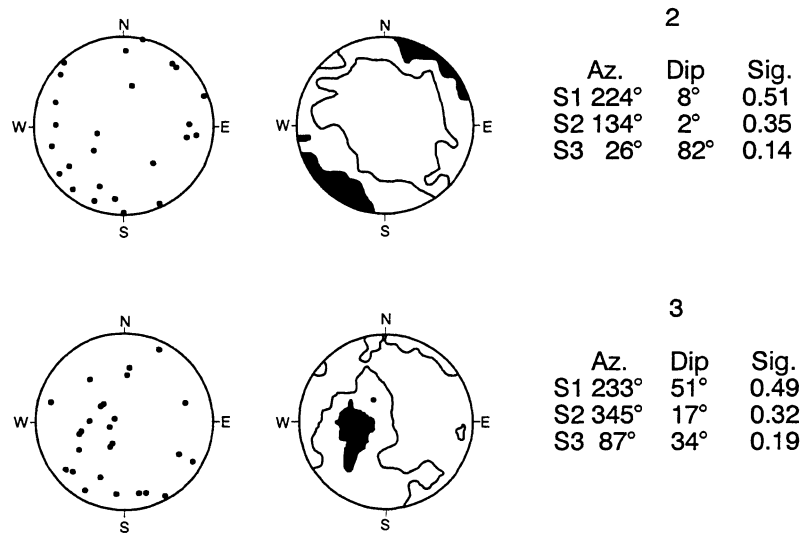
**Figure 8.** The matrix texture of Morgan Member diamictons beds is more variable than that of the thick, massive Alden Member diamicton, but the most common texture is still loam.

individual sheets extend, but they may extend several meters, perhaps as much as 15 m (50 ft). Channel fills tend to be small scale, rarely more than a few meters (5 to 50 ft) in width and usually less than 2 m (6 ft) deep.

Bed contacts are usually abrupt and often contorted. Sometimes conjugate high-angle normal and reverse faults displace the sequence of sorted sediments and diamicton beds in the Morgan Member. The faults appear to have formed as a result of collapse when adjacent or underlying ice melted out (McDonald and Shilts, 1975).

**Nature of Contacts:** The Morgan Member has always been observed overlying other members of the Dows Formation. It occurs as thin to thick sequences, 0.5 to about 8 m (2 to 25 ft) thick, overlying the Alden Member and as generally thin veneers (less than 3 m—10 ft thick) over Pilot Knob Member sand and gravels. Basal contacts with the Alden Member vary from abrupt to gradational, whereas those with the Pilot Knob Member are typically abrupt.

The Morgan Member often occurs at the present land surface. In places it is overlain by either the



**Figure 9.** Representative lower hemisphere scatter plots and equal-area nets showing that rod-shaped (prolate) pebbles within diamicton beds of the Morgan Member typically are neither strongly nor consistently oriented. These two fabrics are from the same diamicton bed. The azimuth, dip, and significance are given for eigenvectors  $s_1$ , (direction of maximum clustering)  $s_2$ , and  $s_3$  (direction of minimum clustering). Adapted from Kemmis (1991).

Lake Mills Member, or the Noah Creek, Peoria, or DeForest formations. Contacts with these units are abrupt and unconformable.

**Differentiation from other Members:** The bedded diamictons and sorted sediments of the Morgan Member are distinctly different than other members of the Dows Formation. The Alden Member differs in being composed almost exclusively of massive diamicton. Diamicton beds are extremely rare in the Lake Mills Member; the member usually consists of massive fine-grained sediment overlying a thin increment of sand and pebbly sand. The Pilot Knob Member also consists predominantly of sorted sediments, but the sediments are dominantly coarse sand and gravel. Diamicton beds may occur within the Pilot Knob sequence at some locales, but they are not abundant. The distinction between the Pilot Knob and Morgan members is made on the abundance of diamicton beds. Deposits are classified as Morgan Member when diamicton beds are abundant; in the field, this usually means that diamicton beds constitute 30% or more of the sedimentary sequence. **Extent and Thickness:** The Morgan Member

varies in both extent and thickness. The member is common in ‘hummocky’ areas where thicknesses vary from thin, 1 to 3 m (3 to 6 ft) in thickness, to thick, 10 m or more (over 30 ft); often the deposits occur as alluvial-fan like wedges draping and flanking ‘hummock’ cores. Morgan Member deposits tend to be thin (2-4 m, 6-12 ft) and generally restricted to linked-depression systems in low-to-moderate relief areas.

**Origin:** The geometry and lithologic properties of the bedded diamictons and sorted sediments comprising the Morgan Member suggest the deposits accumulated primarily in ice-marginal (ice-contact) or supraglacial settings where there was repetitive mass-wasting resulting in the deposition of diamicton beds, and in fluvial/lacustrine environments where sorted sediments accumulated (see Lawson, 1979a, 1979b, and 1989 for a discussion of processes in these environments).

### Lake Mills Member

**Source of name:** the town of Lake Mills, Winnebago County, Iowa.

**Reference Section:** Deposits of the Lake Mills Member are not present at the type section of the Dows Formation, and so the 95 Lake Mills SE section, located in the SE 1/4, SE 1/4, SW 1/4 of section 16, T. 99 N., R. 23 W., Winnebago County, Iowa is designated as the reference section for this member (Kemmis, 1991).

**Description of the Unit:** The Lake Mills Member is usually less than 3 m thick. It typically consists of an upper, massive, generally pebble-free, fine-grained increment overlying a thin basal increment of stratified sand and pebble gravel (Figure 10). The member usually ranges between 0.75 and 3 m (2.5 to 10 ft) thick. Where thin (less than 1 m thick), basal sand and gravels are often absent although a stoneline may be present. Fine-grained deposits predominate the member at all sites, and are typically massive (unless altered by the development of secondary soil structure). Sand content is low, often less than 15%, and clay content is usually greater than 25%. Typical textures include silty clay loam, silty clay, and clay. The basal increment of sand and gravel is usually thin, less than 0.6 m (2 ft) in thickness, and commonly varies across a site. The contact between the upper fine-grained and lower coarse-grained increments varies from abrupt to gradational.

**Nature of Contacts:** Where present, the Lake Mills Member occurs at the land surface. Its lower contact is abrupt and unconformable with either the Morgan or Alden members of the Dows Formation. At some sites, the basal contact is offset by high-angle normal and reversed faults where supraglacial lake deposits collapsed when underlying ice melted out.

**Differentiation from Other Members:** The massive fine-grained sediment and basal sand and gravel of the Lake Mills Member contrast with the poorly sorted diamictos of the Alden and Morgan members. The sorted sediments of the Lake Mills Member are thicker and laterally more extensive than those in the Morgan Member. In contrast to the Pilot Knob Member, the Lake Mills Member is predominantly fine-grained sediment instead of coarse-grained sand and gravel.

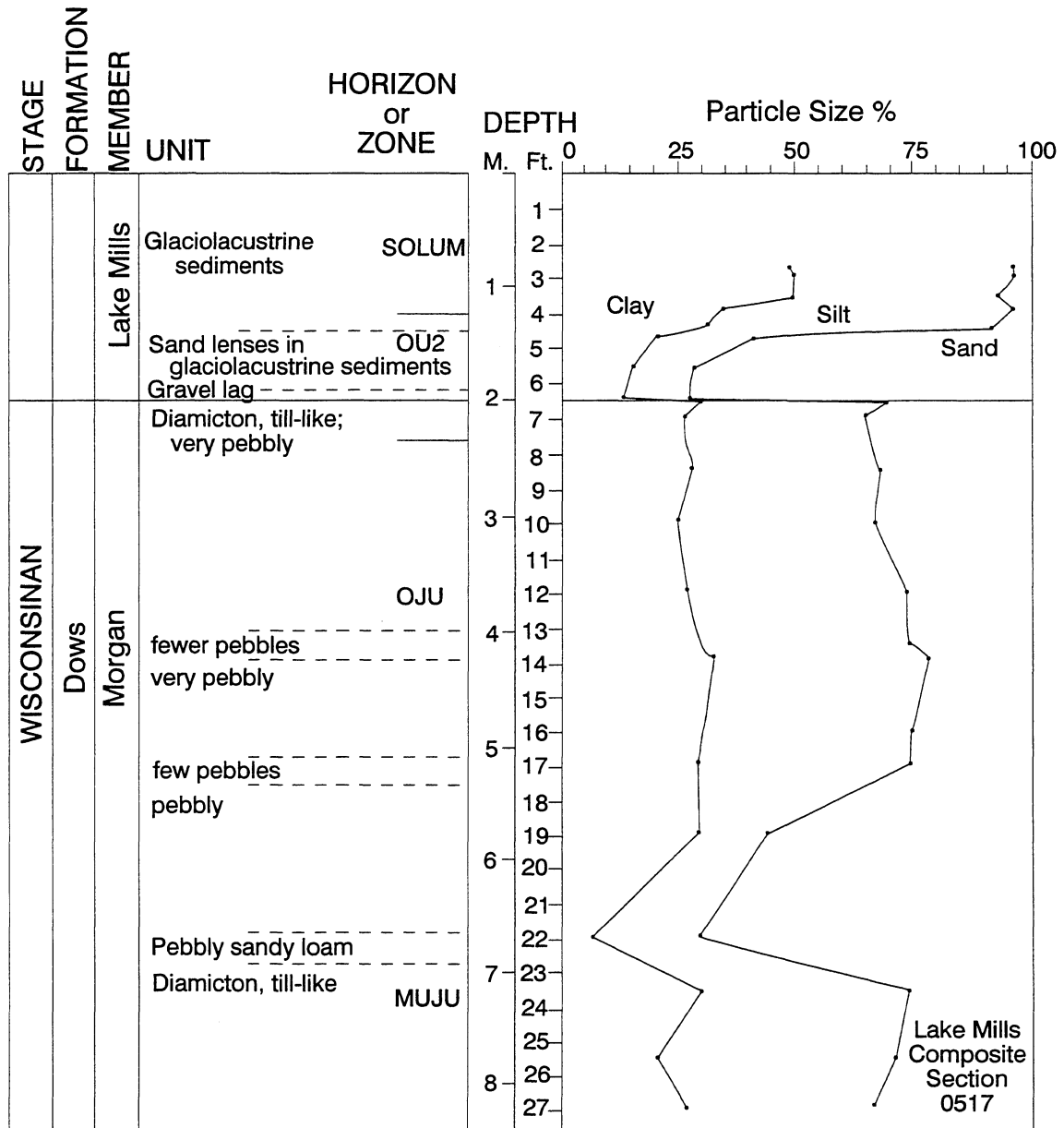
**Extent and Thickness:** The Lake Mills Member

is usually thin, typically ranging between 0.75 and 3.0 m (2.5 to 10 ft) in thickness. It occurs as a mantle on certain circular “hummocks” outlined by linked-depression systems comprising former ice-marginal positions of the Bemis, Altamont, and Algona advances (Graeff, 1986; Kemmis, 1991). It also occurs over broad, undulating uplands denoted as Glacial Lake Jones (Kemmis, 1981), Glacial Lake Wright, and Glacial Lake Story City. The exact extent and depositional setting of each of these three glacial lakes needs further research. Preliminary work suggests that Glacial Lake Jones is related to proglacial drainage of the Algona advance blocked by landforms of the older West Bend advance to the south. Glacial Lake Wright, located just behind the Altamont margin, is similar in setting to supraglacial lakes that form behind the bulged margin of surging glaciers during the quiescent phase after a surge advance (Croot, 1978). The origin of Glacial Lake Story City (locally called the ‘Story City Flats’) is unknown.

**Origin:** The massive, laterally uniform fine-grained sediments of the Lake Mills Member were deposited in glacial lakes. These lakes probably occurred in different depositional environments. The Lake Mills Member, where it mantles the tops of ‘hummocks’ at the reference section and at other hummocky sites bordered by linked-depression systems at or near former ice-marginal (‘end moraine’) positions, formed in supraglacial or ice-walled lakes (Graeff, 1986; Kemmis, 1981 and 1991). Some sites, like Glacial Lake Jones in front of the Algona glacial margin in Kossuth and Hancock counties, appear to have formed as proglacial lakes.

The fine-grained upper increment that dominates stratigraphic sequences of the Lake Mills Member is typically massive, lacking *varve couplets*, suggesting that the sediment was deposited in shallow lakes. Varves only form where lakes are deep enough for thermal stratification to develop and seasonal turnover to take place. Paleoenvironmental interpretations based on fossil ostracode assemblages collected from a site similar to the reference section, but 0.5 km (1/4 mile) away, indicate that the environment was in

# STRATIGRAPHY



**Figure 10.** Stratigraphy and particle-size data for the 95 Lake Mills SE site, the reference section for the Lake Mills Member of the Dows Formation, Winnebago County, Iowa. From Kemmis (1991).

the littoral (near shore) zone where lake depth was shallow, ranging between 0.6 and 3.0 m (2 to 10 ft), and mean annual temperature was between 0.8° and 3.6° C (33.5° to 38.5° F) (Graeff, 1986). The present mean annual temperature in the Lake Mills area is 8° C (46.3° F).

The thin zone of coarser sand and gravel often found at the base of the Lake Mills Member either formed from initial wave wash on the underlying Morgan or Alden members or as coarse sediment influx into the lake from adjacent lake margins (which were ice-cored in some settings).

### **Pilot Knob Member**

**Source of name:** Pilot Knob, the prominent glacial hummock in Pilot Knob State Park, located east of Forest City, Winnebago County, Iowa.

**Reference Section:** Deposits of the Pilot Knob Member are not present at the type section for the Dows Formation, but are well exposed in an excavation at the 98 LaHarv-1 site, located in an east-west trending esker in the NE 1/4, SE 1/4, SE 1/4 of section 30, T. 98 N., R. 22 W., Worth County, Iowa which is designated as the reference section for the member.

**Description of the Unit:** The Pilot Knob Member consists predominantly of sands and gravels occurring in irregularly shaped hummocks and low-sinuosity ridges in uplands on the Des Moines Lobe. Textures and bedding structures often vary significantly over short distances both laterally and vertically. Bedding structures include all of the flow-regime bedforms described by Simons et al. (1965) and the various channel-fill types recognized by Ramos and Sopena (1983). Beds of virtually pebble-free, fine-grained sediment and diamictos sometimes occur at the top of or within the member, but are uncommon. The diamicton beds tend to occur as isolated, channelized pods. The stratified sequence comprising the member is sometimes offset by high-angle normal and reverse faults resulting from collapse of the sediment when the glacier's supporting ice walls melted away. The modern soil profile is developed in the top of the Pilot Knob Member where it is the surficial deposit. Sands and gravels within the

member are oxidized where they occur above the water table and unoxidized below.

**Nature of Contacts:** The base of the Pilot Knob Member is rarely exposed. It is presumed to be unconformable on underlying diamicton sequences of the Morgan Member or the massive diamicton of the Alden Member. At many sites the Pilot Knob Member occurs at the land surface. At some sites it is overlain unconformably by 3 m (10 ft) or less of interbedded diamictos and sorted sediments of the Morgan Member or by a stoneline and thin colluvium of the Flack Member of the DeForest Formation.

**Differentiation from Other Members and Formations:** Unlike all other members of the Dows Formation, the Pilot Knob Member is composed predominantly of coarse sand and gravel. Although diamicton beds are locally present in the member, they do not comprise the bulk of the sequence as they do in the Morgan Member.

The sand and gravel sediments comprising the Pilot Knob Member are similar to the fluvial and glaciofluvial sands and gravels of the Noah Creek Formation, but there tends to be greater variability, both laterally and vertically in the Pilot Knob Member. The Pilot Knob Member also occupies a distinct geomorphic position, that being upland hummocks and ridges, whereas the Noah Creek Formation is confined to stream valleys and outwash plains.

**Extent and Thickness:** The Pilot Knob Member occurs in irregular hummocks and low-sinuosity ridges across the Des Moines Lobe. The hummocks are usually a few hundred meters in diameter, and the narrow, sometimes beaded ridges usually extend from 1 to 3 km (1/2 to 1 1/2 mile). Relief on the hummocks and ridges is usually 6 to 13 m (20 to 40 ft), but locally may be greater. The range of thicknesses for the member is uncertain, but is generally greater than 3 m (10 ft). Maximum thicknesses are estimated to be 10 to 15 m (30 to 50 ft).

**Origin:** Like classic kames and eskers (e.g., Flint, 1971; Banerjee and McDonald, 1975; Sauderson, 1975; Sugden and John, 1976), deposits of the Pilot Knob Member appear to have formed in stagnant-ice environments. The sands and gravels

were probably deposited by meltwater flowing in *moulins* and subglacial and *englacial* tunnels. Diamicton beds within the member appear to be debris flows into the tunnels as surrounding ice melted. High-angle normal and reversed faults within the Member formed when the sediments collapsed as surrounding ice walls melted away.

## NOAH CREEK FORMATION

The Noah Creek Formation is composed predominantly of coarse-grained sand and gravel deposited in present and abandoned stream valleys, and on outwash plains.

**Source of name:** Noah Creek, a tributary to the Des Moines River near the formation's type section, Boone County.

**Type Section:** the 8 Hallett-1 Section located on a benched terrace along the west side of the Des Moines Valley in the NW 1/4, NW 1/4, section 36, T. 84 N., R. 27 W., Boone County, Iowa (Bettis et al., 1988).

**Description of the Unit:** The Noah Creek Formation consists of a thin upper increment of fine-grained sediment usually ranging between 0.3 and 1.5 m (1 to 5 ft) thick overlying thick sand and gravel that typically exceeds 5 m (15 ft) in thickness. Bedding structures in the thick lower sequence of sand and gravel include all of the flow-regime bedforms described by Simons et al. (1965) and the various channel-fill types recognized by Ramos and Sopena (1983). In settings proximal to ice advances, the formation's deposits may exhibit collapse structures related to melt out of ice blocks buried in the outwash sequence.

Secondary alteration includes soil formation throughout the upper fine-grained sediment, with other pedogenic alterations (such as beta horizons) sometimes extending down into the upper part of the underlying sand-and-gravel sequence. The sands and gravels are oxidized above the water table and unoxidized below.

**Nature of Contacts:** On outwash plains, the Noah Creek Formation can conformably or unconformably overlie the Dows Formation. Where the Noah Creek Formation is inset below the uplands in a valley geomorphic position, it

unconformably overlies the Dows Formation, older Quaternary sediments, or Paleozoic bedrock into which the stream has incised. It occurs at the land surface of higher stream terraces on the Lobe, and is unconformably buried by the DeForest Formation beneath alluvial fans, low stream terraces, and the modern flood plain.

**Differentiation from other Units:** The thick, coarse, sand-and-gravel sequences comprising the Noah Creek Formation are unlike any of the other formations on the Des Moines Lobe. The Dows Formation occurs in a different geomorphic position, and the Alden and Morgan members are predominantly diamictons rather than sand and gravel. The Lake Mills Member is dominantly fine-grained sediment, and, if present, the basal sand-and-gravel is very thin and generally finer grained than the Noah Creek Formation. The Pilot Knob Member is lithologically similar to the Noah Creek Formation, but differs in geomorphic position (upland hummocks and ridges rather than stream valleys), and tends to have greater variability over short distances. The sand facies of the Peoria Formation (see below) is pebble-free, exhibits better sorting, and has different bedforms than the Noah Creek Formation.

The DeForest Formation differs, being composed primarily of fine-grained alluvium. Sand and gravel in any of the DeForest Formation members is thinner, finer textured, and less laterally extensive than that comprising the Noah Creek Formation.

**Extent and Thickness:** The Noah Creek Formation occurs on outwash plains and in stream channels that drained the Des Moines Lobe, including river valleys and abandoned outwash channels. In river valleys, the Noah Creek Formation underlies terraces and flood plains. Three different terrace morphologies are recognized in the field: cut-off, longitudinal, and point types. A general comparison of the sedimentary sequences associated with the different terrace morphologies is presented in Table 4. Some differences in bedding structures are found in the different terrace types because of stream-flow variations between the terrace types, and there are downvalley differences in both val-

**Table 4.** Comparison of Late-Wisconsinan-age valley-train terrace types associated with the Des Moines Lobe, Iowa. Modified from Quade, 1992.

	LONGITUDINAL	POINT	CUT-OFF
<b>GEOMORPHIC SETTING</b>	<b>Position-</b> Parallels straight orientation of river valley reaches. This terrace type is present in both distal and proximal settings and on the lowest (youngest) Late Wisconsinan terrace levels.	<b>Position-</b> Deposited on the inside of valley meanders. This terrace type occurs primarily in distal reaches and on lowest (youngest) Late Wisconsinan terrace levels.	<b>Position-</b> Cut into valley walls. This terrace type is restricted to distal reaches of the highest (oldest) Late Wisconsinan terrace levels.
<b>SEDIMENTOLOGY AND STRATIGRAPHY</b>	<b>Upper increment-</b> In proximal terraces the upper increment is composed of a massive to crudely planar-bedded cobble gravel <1-2 m thick with large-scale, low-amplitude channel fills (>4 m wide) incised into the massive gravel beds. In distal terraces the upper increment is a massive to fining upward sand to loamy sand <1 m thick. <b>Middle increment-</b> Proximal terraces have a middle increment composed of complex and planar crossbedded pebbly sand and pebble gravel which are truncated by simple channel fills 1->4 m thick. Distal terraces consist of a 1-2 m thick matrix-supported cobble gravel with imbricated clasts. <b>Lower increment-</b> composed of large-scale, crossbedded sand to pebble gravel, truncated by simple channel fills.	<b>Upper increment-</b> consists of a massive to fining upward sand to loamy sand <1 m thick. <b>Middle increment-</b> consists of a 1-2 m thick matrix-supported cobble gravel with imbricated clasts. <b>Lower increment-</b> composed primarily of large-scale lateral accretion bedforms and crossbedded sand to pebble gravel, truncated by simple channel fills.	<b>Upper increment-</b> The upper increment is composed of a massive to fining upward (<1 m) sequence of sand to sandy loam. <b>Middle increment-</b> This unit is composed of pebbly sand to pebble gravel in a series of simple and complex channel fills incised into the underlying crossbedded sediments. <b>Lower increment-</b> This is commonly the thickest increment from (2-5 m) thick and dominated by laminated and planar crossbeds of sand and pebbly sand.
<b>INTERPRETATION OF DEPOSITIONAL HISTORY</b>	The various lower increment lithofacies are an assemblage of meso- and micro-forms (dunes, sand waves, ripples, etc.) that suggest deposition related to fluctuating discharge of water and sediment. We interpret these fluctuating discharge conditions to represent "normal" diurnal and seasonal variations of glacial meltwater streams. The middle increment deposits indicate a significant change of scale from meso- and micro-forms of the lower increment to large-scale, terrace-wide deposition. The very poorly sorted cobble gravels characteristic of this increment indicate a stream with very high sediment load, and simultaneous deposition of bed- and suspended-load. We interpret this increment as sediment deposited during an infrequent, very high magnitude glacial flood that also caused lateral downcutting to the next lowest terrace level in the valley. The upper increment is interpreted to have been deposited during waning flow or overbank conditions associated with middle increment floods. Some upper increment sediment has been subsequently reworked by wind.		

ley morphology and sedimentary sequence as well (Kemmis et al., 1987, 1988; Kemmis, 1991). Most of the terraces are 'benches' cut into the upland with only a veneer of sand and gravel covering them. Thickness of the veneer varies, but commonly is on the order of 6 m (20 ft). The Noah Creek Formation also occurs in abandoned outwash channels at the margin of former ice advances and in associated outwash plains

**Origin:** The Noah Creek Formation was deposited as outwash or redeposited outwash along stream valleys, outwash channels, and in outwash plains. All major rivers on the Des Moines Lobe have their source at the margin of former ice advances ('end moraines'), and the morphology of their valleys

reflects their origins as glacial sluiceways.

Glacial drainage is characterized by extreme variation in streamflow both on annual scales, as conditions change from winter freeze-up to early summer floods when the glacier's snow pack rapidly melts off, and on longer term scales when unusually large flood flows, *jokulhlaups*, occur (Church and Gilbert, 1975; Smith, 1985). This variability in streamflow is reflected in the wide range of bedding structures and sand-and-gravel textures comprising the Noah Creek Formation. Terraces in the distal part of major rivers on the Des Moines Lobe consist of three distinctive increments: a thick, highly variable lower increment that is interpreted to record normal fluctuations in outwash



systems on annual scales; a 1 to 2 m (3 to 5 ft) thick middle increment consisting of poorly sorted, planar-bedded cobble gravels extending across the terrace that appears to result from major floods; and a thin veneer of fine-grained sediment capping the terrace that results from waning flow and overbank sedimentation (Kemmis et al., 1987; 1988). Figures 11 and 12 show grain-size data from cut-off and longitudinal-type terraces that illustrate differences in grain size between the increments.

**Age:** On the Des Moines Lobe, the Noah Creek Formation dates from about 14,000 to 11,000 RCYBP. The oldest advance of the Des Moines Lobe is dated at about 14,000 RCYBP (Ruhe, 1969; Kemmis et al., 1981) when deposition of the Noah Creek Formation was initiated. Deposition of the Noah Creek Formation ceased by 11,000 RCYBP. Wood from the oldest DeForest Formation alluvium in the Des Moines River valley, which is inset into and therefore younger than the Noah Creek Formation, dates at 11,000  $\pm$  290 RCYBP (Beta-10882; Bettis and Hoyer, 1986).

## PEORIA FORMATION

The Peoria Formation consists of wind-transported sediments and occurs throughout Iowa.

**Source of name:** the city of Peoria, Peoria County, Illinois.

**Type Section:** the Tindall School Section, a borrow pit in the west bluff of the Illinois Valley south of Peoria, Peoria County, Illinois, in the SW 1/4, SW 1/4, NE 1/4 of section 31, T. 7 N., R. 6 E. (Willman and Frye, 1970).

**Description of Unit:** The Peoria Formation includes wind-transported sediments. Two facies are recognized in Iowa, a silt facies (loess) and a sand facies (eolian sand). The sediments are well sorted and the two facies may be interbedded. Textures range from silt loam to medium-to-fine sand. Macroscopic bedding structures are rare and are found primarily in locations proximal to a valley source where the formation's sediments are thick. Where present, bedding structures include planar beds with inverse grading in the silt facies,

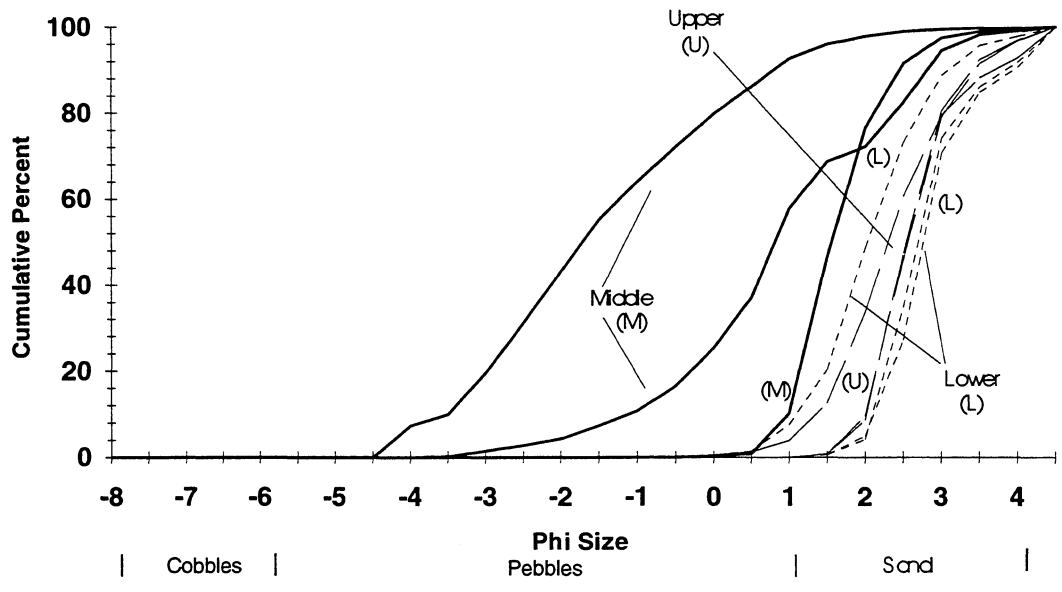
and planar beds to steep foresets in the sand facies. Where eolian sand overlies sand-and-gravel deposits of the Noah Creek Formation it is included in that formation. On the Des Moines Lobe, secondary pedogenic alteration has modified most Peoria Formation deposits.

**Nature of Contacts:** The Peoria Formation usually occurs at the land surface. It abruptly and unconformably overlies older Quaternary formations and paleosols developed in them. Beneath the Des Moines Lobe the silt facies of the formation is buried by Dows Formation glacial diamicton, while the sand facies occurs at the land surface and abruptly and unconformably overlies the Dows Formation. The contact with other units is marked by an abrupt change in texture, sedimentary structures, fossil content, or secondary weathering characteristics.

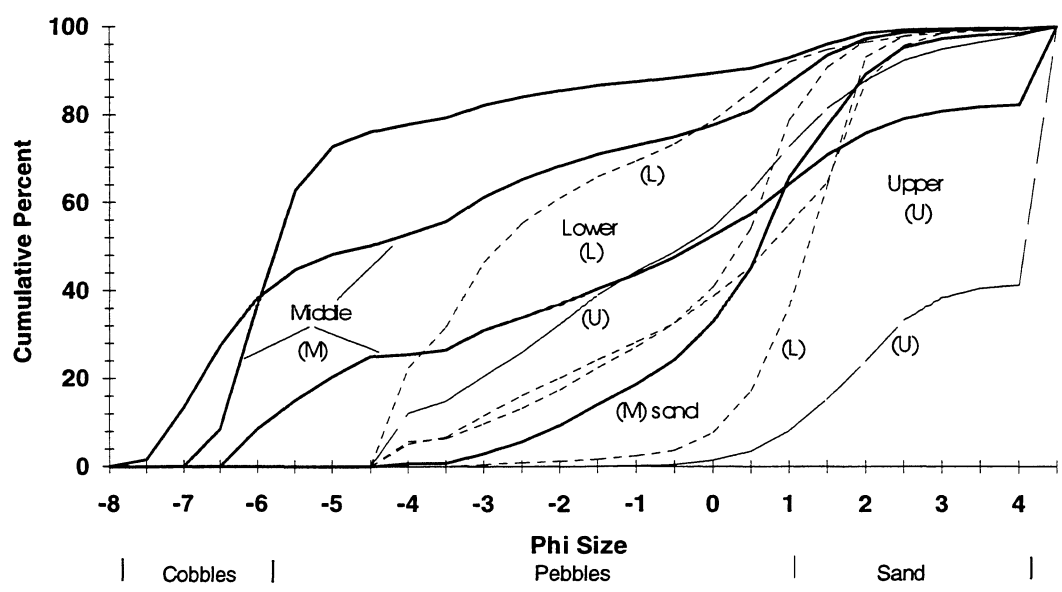
**Differentiation From Other Units:** The wind-sorted sediments of the Peoria Formation are generally unlike the deposits of any other formation on the Des Moines Lobe. The Lake Mills Member of the Dows Formation consists of fine-grained sediment, but it has greater variability, a higher clay content, and occurs in a different geomorphic setting. The Noah Creek Formation and Pilot Knob Member of the Dows Formation are more poorly sorted and contain coarse sand and gravel. The DeForest Formation contains some sandy sediment, but the bedding structures and sorting of these are distinct from those associated with the Peoria Formation.

**Regional Extent and Thickness:** The Peoria Formation occurs on uplands and high terraces throughout Iowa. In north-central Iowa, the silt facies of the formation is buried by glacial diamicton of the Dows Formation, except in very restricted, small areas adjacent to major river valleys in the southern part of the Lobe. On the Des Moines Lobe, the formation is usually restricted to a narrow belt on the upland along major stream valleys.

Thickness varies with respect to distance from the valley source. Proximal to the Missouri Valley in western Iowa, the formation usually is more than thirty meters (90 ft) thick. On the Des Moines Lobe the formation ranges from a few centimeters to about three meters (9 ft) in thickness.



**Figure 11.** Summary grain-size data for sediments associated with a distal cut-off terrace in the Iowa River valley in Hardin County, Iowa. The diagram shows that the upper increment is coarse sand, the middle increment is dominantly pebble gravel, and the lower increment ranges from fine pebble gravel to sand. Overall, sediments associated with cut-off terraces are finer grained than those associated with longitudinal-type terraces. From Quade (1992).



**Figure 12.** Summary grain-size data from sediments associated with a distal longitudinal terrace in the Iowa River valley in Hardin County, Iowa. The upper increment ranges from pebble gravel to sandy loam, the middle increment is dominantly cobble gravel with a few beds of laminated sand (M sand), and the lower increment is dominantly pebble gravel. From Quade (1992).

**Origin:** The Peoria Formation consists of wind-deposited sediment. The formation's sediments were derived from wind reworking of valley-train outwash. The sand facies also includes sediments reworked from older eolian sand deposits.

**Age:** The Peoria Formation is time transgressive. The silt facies was deposited between about 22,000 and 12,500 RCYBP, while the sand facies includes deposits that accumulated contemporaneous with the silt facies, as well as others that accumulated during the Holocene to the present. Most Peoria Formation deposits on the Des Moines Lobe accumulated between about 14,000 and 11,000 RCYBP, and have undergone various degrees of wind reworking during the Holocene.

## DEFOREST FORMATION

The DeForest Formation consists of fine-grained alluvium, colluvium, and pond sediment in stream valleys, on hillslopes and in closed and semi-closed depressions. The formation was originally defined by Daniels et al. (1963) for a repeatable sequence of alluvial fills in the Loess Hills of western Iowa. Subsequent study of drainage basins across Iowa revealed that a consistent alluvial stratigraphy was present, but its classification required expansion and revision of the formation (Bettis, 1990). The revised DeForest Formation includes the Gunder, Roberts Creek, Camp Creek, and Corrington members, all recognized on the Des Moines Lobe (Bettis, 1990; Bettis et al., 1992). These members are not described here for the sake of brevity. However, three new members are added to the formation and are introduced here. These new members are the Flack Member, consisting of colluvium mantling hillslopes, the Woden Member, for sediment fills in semi-closed and closed depressions, and the West Okoboji Member for lake sediment associated with extant lakes.

**Source of name:** the DeForest Branch of Thompson Creek, Harrison County, Iowa, one of the watersheds originally studied by Daniels et al. (1963).

**Type Sections:** The original type sections were composed of loess-derived alluvium in a small

western Iowa watershed (Daniels et al., 1963). Type sections for the Gunder and Roberts Creek members occur along Roberts Creek, Clayton County, in the Paleozoic Plateau region of north-eastern Iowa. The type section for the Camp Creek Member occurs in Woodbury County in the Loess Hills of western Iowa, and the type section of the Corrington Member occurs in Cherokee County along the Little Sioux Valley in the Northwest Iowa Plains region.

**Description of Unit:** The DeForest Formation consists of fine-grained alluvium, colluvium, and pond sediments. A minor component of most members is sand or pebbly sand which, if present, is usually discontinuous, filling small scour channels at the base of the member or at the base of depositional units within members. Peat and muck occur in the Woden Member and infrequently as thin, local, discontinuous beds within the Gunder, Roberts Creek, and Camp Creek members.

Except where the tops of members have been erosionally truncated, soil profiles are developed in all members of the formation except the West Okoboji Member. Weakly expressed buried soils are locally preserved in all members except the Flack and West Okoboji. These buried soils reflect periods of landscape stability, but they are not widely traceable, even in individual drainage basins. They appear to record only short-lived local conditions. Secondary weathering-zone properties in the members vary with the depth and elevation of the water table.

**Nature of Contacts:** The DeForest Formation occurs at the land surface. It abruptly and unconformably overlies the Dows, Noah Creek, and any older Quaternary and Paleozoic formations into which it is incised. The contact is marked by an abrupt change in texture, sedimentary structures, and fossil content.

**Differentiation from other Units:** The alluvium, colluvium, and pond sediments of the DeForest Formation are generally unlike the deposits of any other formation on the Des Moines Lobe. The Lake Mills Member of the Dows Formation consists of fine-grained sediment, but it tends to have a higher clay content and occurs in a different geomorphic setting (uplands instead of stream

valleys). The Noah Creek Formation and the Pilot Knob Member of the Dows Formation are predominantly coarse sand and gravel. The Alden and Morgan members of the Dows Formation include poorly sorted diamicton deposits, which the DeForest Formation typically lacks. The Peoria Formation occurs on high terraces and uplands and is better sorted than DeForest Formation deposits.

**Regional Extent and Thickness:** The DeForest Formation occurs in stream valleys, closed depressions, and on hillslopes across Iowa, and on the Des Moines Lobe it also occurs in linked-depression drainageways. Thickness varies with geomorphic position and local relief. Where present, the formation varies in thickness from a few centimeters (inches) to several meters (greater than 20 feet) thick.

**Origin:** The DeForest Formation consists of post-glacial alluvium, colluvium, pond deposits, and organic sediment (peat and muck) that were deposited by or in water.

**Age:** The base of the DeForest Formation is time-transgressive. On the Des Moines Lobe it is younger than 11,000 RCYBP in most areas, but is locally as old as 14,000 to 11,000 RCYBP. Deposition of the DeForest Formation continues to the present. The age of individual members is also time-transgressive, dependent on position in the drainage system and on geomorphic position.

### **Flack Member**

**Source of name:** the Flack farm on which the type section is located, Story County.

**Type Section:** The type section is the 85 Flack Section, an east-west trending stream cut exposing a hillslope descending to East Indian Creek in the NE 1/4, NE 1/4, NW 1/4 of section 2, T. 83 N., R. 22 W., Story County, Iowa (Figure 13).

**Description of Unit:** The Flack Member comprises colluvium on and at the base of hillslopes. Where present, the base of the Member is commonly marked by a stoneline that is discontinuous on upper slopes, gradually becoming continuous downslope. The lower part of the member usually consists of pebbly loam in which the pebbles become finer and less abundant upward. This

gradation and distribution of pebbles is different than that of the diamictons comprising the Dows Formation. This lower portion of the member thickens and becomes slightly coarser in footslope positions. The pebbly lower portion of the member often grades to pebble-free loam in the upper part. The modern soil has developed in the upper part of the member, and morphologic characteristics vary with local slope, vegetation, and drainage conditions.

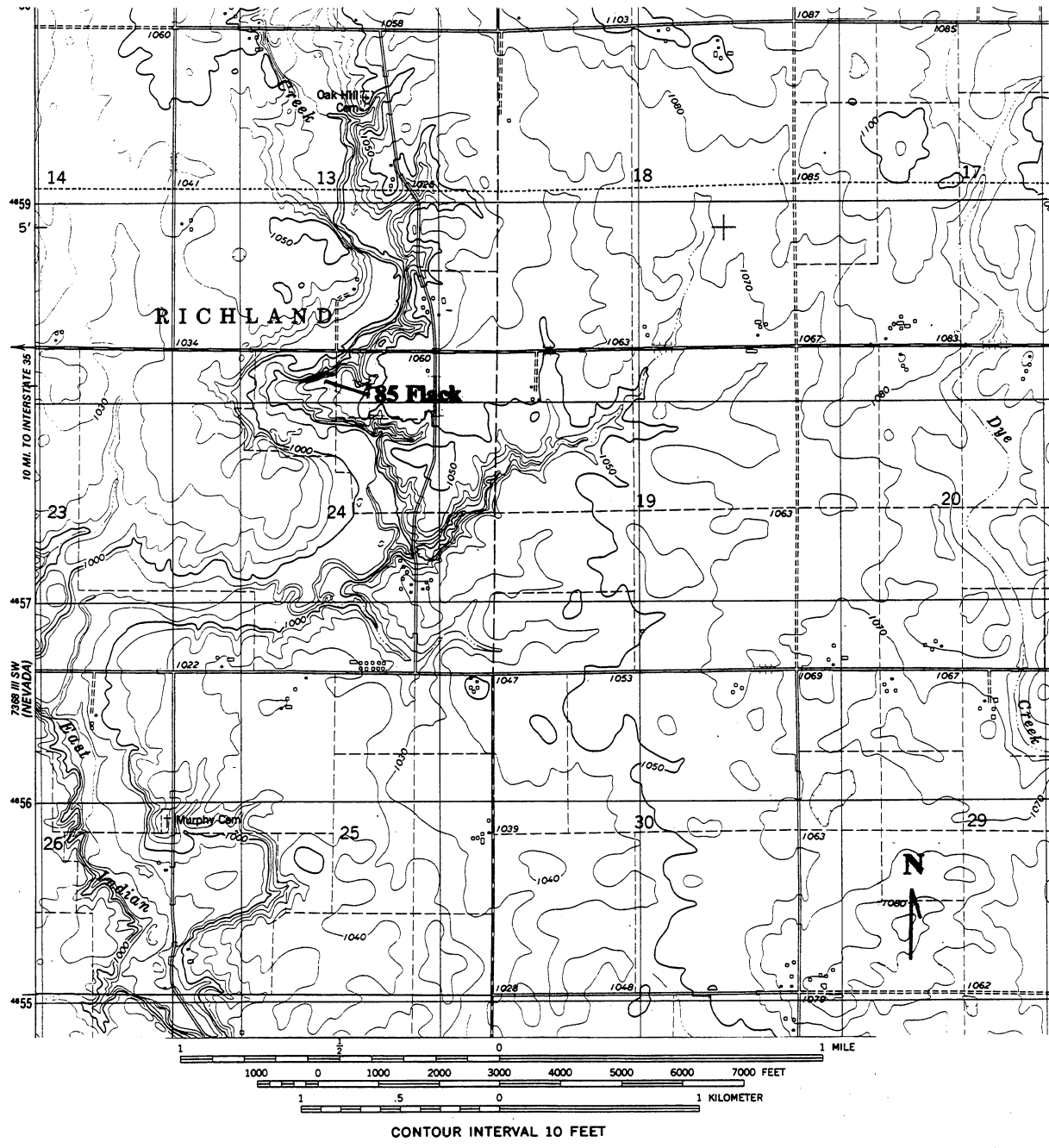
**Nature of Contacts:** The Flack Member unconformably overlies the Dows Formation and any older formations into which the member has incised. The basal contact is usually marked by a stoneline (Ruhe, 1956), a gravel lag left from the erosion of diamicton sediments. The stoneline is often discontinuous on the upper part of hillslopes, grading to continuous downslope. On the lower portions of hillslopes, the Flack Member may be overlain by thin colluvium of the Camp Creek Member. The contact is usually marked by an abrupt change in color between the dark soil A horizon developed in the Flack Member and the lighter colored Camp Creek Member, and by a change in structure.

**Differentiation from other Members:** The Flack Member is composed primarily of fine-grained sediment with a coarser increment at the base like other members of the DeForest Formation. However, it is usually more poorly sorted, thinner than other members, and it only occurs on and at the base of slopes. It grades downslope to the Gunder, Corrington, Roberts Creek, and Woden members, and may locally interfinger with the Gunder, Corrington, and Roberts Creek members at the base of steep slopes.

**Extent and Thickness:** On the Des Moines Lobe, the Flack Member discontinuously mantles upland hillslopes. It usually thickens downslope, but rarely exceeds 1 m (3.5 ft) in thickness.

**Origin:** The Flack Member consists of thin colluvium resulting from sheetwash, rill erosion, and mass movement on upland hillslopes.

**Age:** The Flack Member is Holocene in age. Deposition was time transgressive, dependent on landscape position and factors affecting local hillslope stability.



**Figure 13.** Location of the 85 Flack section, type section of the Flack Member of the DeForest Formation in Story County, Iowa. Base from U.S.G.S. Nevada and Colo 7.5' quadrangles.

**Previous usage:** This is the first time the Flack Member has been used. Wallace and Handy (1961) previously recognized stonelines on the Des Moines Lobe, and correlative sediment has informally been referred to as ‘hillside surficial sediment’ and ‘hillside surficials’ by Walker (1966) and as ‘surficial sediment’ and ‘surficials’ by Daniels and Handy (1966).

## Woden Member

**Source of name:** Woden Bog, type section for the Woden Member, Hancock County.

**Type Section:** The type section for the Woden Member is a drill core, 41 Woden Bog W1, located in the NE 1/4, NW 1/4 of section 13, T. 97 N., R. 26 W., Hancock County, Iowa (Walker, 1966). This site is located in the center of a depression that is part of a large linked-depression drainageway associated with the Algona ice margin (Figure 14).

**Description of Unit:** The Woden Member consists of alternating zones of fine-grained colluvium and organic sediment in semi-closed and closed depressions on the Des Moines Lobe. The stratigraphic sequence differs slightly between small and large depressions. Large depressions consist of alternating mineral sediment (colluvium) and organic material. Walker (1966) demonstrated that two successions of these deposits occur in large depressions on the Des Moines Lobe, and he informally designated these units as the lower silt, lower muck, upper silt, and upper muck. Thicknesses and textures varied dependent on position in the depression, depth and local relief around the depression, and water table elevation. The units were interpreted to relate to periods of differing hillslope stability during the Holocene caused by changing vegetation and climate. The silt units were related to periods of hillslope instability and the predominant deposition of colluvial deposits, and the muck units related to periods of hillslope stability when organic matter accumulation was greater than colluvial deposition. The “silt” units are often stratified and include silt loam, loam, sandy loam, loamy sand, sand, and pebbly sand textures. The coarsest mineral sediment usually occurs at the base of the depression in the lower

silt. The mineral sediment is usually a reduced light gray color at the base, grading upward to black, organic-coated sediment. Thicknesses of the black, organic-coated sediment vary dependent on local drainage-basin history and conditions. The “muck” units include peat, muck, and organic-rich mineral sediment. Because of the historic draining of wetlands, the upper peat and muck at many sites is now degraded.

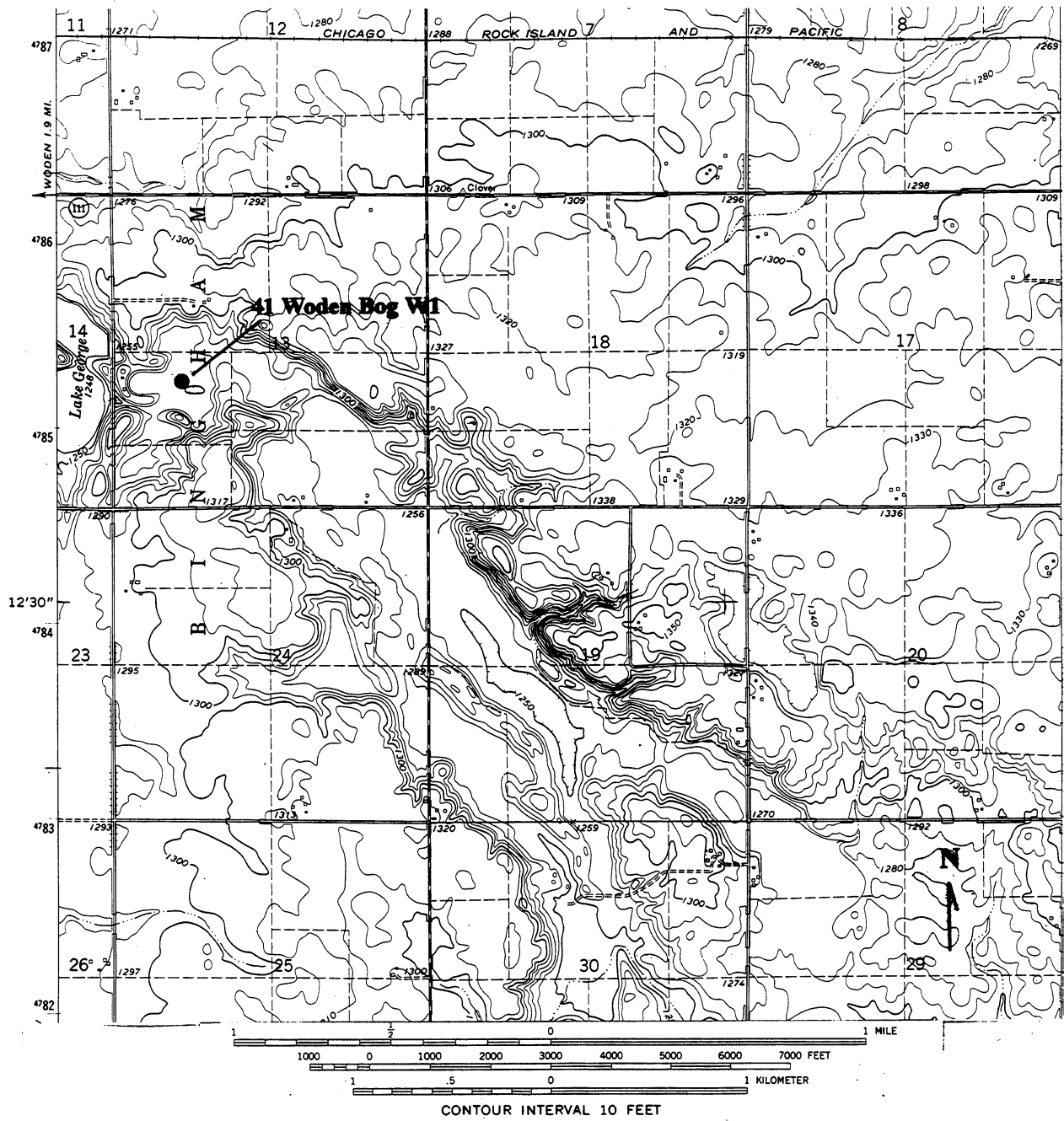
Smaller depressions have a simpler stratigraphy, usually consisting of only fining upward mineral sediment overlain by organic deposits (Walker and Brush, 1963; Kim, 1986).

**Nature of Contacts:** The Woden Member unconformably overlies deposits of the Dows or Noah Creek formations. The basal contact is usually marked by an abrupt change in texture, bedding structures, and color. The basal contact is difficult to identify where coarse basal colluvium overlies sand and gravel of the Noah Creek Formation.

In some watersheds, the Woden Member is overlain by thin colluvium of the Camp Creek Member. In these cases, there is an abrupt contact between the stratified, lighter colored, brown sediment of the Camp Creek Member and the massive black peat or muck at the top of the Woden Member.

**Differentiation from other Members:** The Woden Member differs from other members of the DeForest Formation in geomorphic position and the nature of the stratigraphic sequence. It is restricted to semi-closed and closed depressions, and unlike other members, organic sediments (peat and muck) are common in the sequence, capping depositional units.

**Regional Extent and Thickness:** On the Des Moines Lobe the Woden Member is restricted to semi-closed and closed depressions. Thicknesses vary dependent on the size of the depression, the height and steepness of the surrounding slopes, and the depth of the water table, lake or marsh. The base of the depressions is often uneven, consisting of a series of coalescing basins (Walker, 1966). The thickest Woden Member deposits occur near depression centers. Smaller depressions typically have fills less than 2.5 m (8 ft) thick in the center. Larger depressions have central fills varying from



**Figure 14.** Location of core W1, type section of the Woden Member of the DeForest Formation. Located in a marsh in a linked depression along the southern margin of the Algona Moraine in Hancock County, Iowa. Base from U.S.G.S. Crystal Lake 7.5' quadrangle.

about 4 to 11 m (12 to 35 ft) in thickness.

**Origin:** Mineral sediment in the Woden Member is primarily colluvium and sheetwash derived from erosion of adjacent slopes. Some of this sediment has subsequently been reworked by various processes in the wetland depressions. The organic sediment formed during periods when adjacent slopes were relatively stable and organic matter accumulation rates exceeded mineral sediment depositional rates (Walker, 1966).

**Age:** The base of the Woden Member is time transgressive across the Des Moines Lobe, dating from the final wastage of glacial ice from the area (ca. 14,000 RCYBP in central Iowa to ca. 12,000 RCYBP in northern Iowa). Deposition has continued to the present, but depositional rates through the Holocene varied (Walker, 1966). Where there has been extensive erosion of adjacent slopes during the Historic period, the Woden Member is buried by Camp Creek Member colluvium.

### West Okoboji Member

**Source of Name:** West Okoboji Lake, Dickinson County, the location of the type section.

**Type Section:** Little Millers Bay core, collected in two meters of water in the northernmost portion of Millers Bay, a western projection of West Okoboji Lake, SW 1/4 SW 1/4, NE 1/4 of section 23, T. 99 N., R. 37 W., Dickinson County, Iowa (Van Zant, 1979; Figure 15). This is within the Bemis/Altamont ice margin complex.

**Description of Unit:** The West Okoboji Member comprises lake sediment associated with extant lakes on the Des Moines Lobe. The lower part of the member usually consists of organic-rich silt, and the remainder of the unit is dominantly *gyttja*, sometimes with lenses of silt, sand, and pebbles. Shells and plant macrofossils are common.

**Nature of Contacts:** The West Okoboji Member abruptly and unconformably overlies glacial diamicton of the Dows Formation. Laterally the Okoboji Member may interfinger with sediments of the Woden Member, or unnamed sandy and gravely sediments of ice-push ridges. In most

cases the member is overlain by lake water.

**Differentiation From Other Members:** The West Okoboji Member differs from other members of the formation, except the Woden Member, in geomorphic position and nature of the stratigraphic sequence. The West Okoboji Member differs from the Woden Member in that it does not contain peat or muck, generally lacks root traces, and is covered by more than one meter of standing water.

**Regional Extent and Thickness:** The West Okoboji Member is restricted to extant lake basins on the Des Moines Lobe. Thicknesses vary depending on the size of the lake and the topography of the pre-West Okoboji surface in the lake basin. The thickest sections occur in depressions in the lake basin and near the location of surface drainage inlets. At the type section the member is 11.7 m thick.

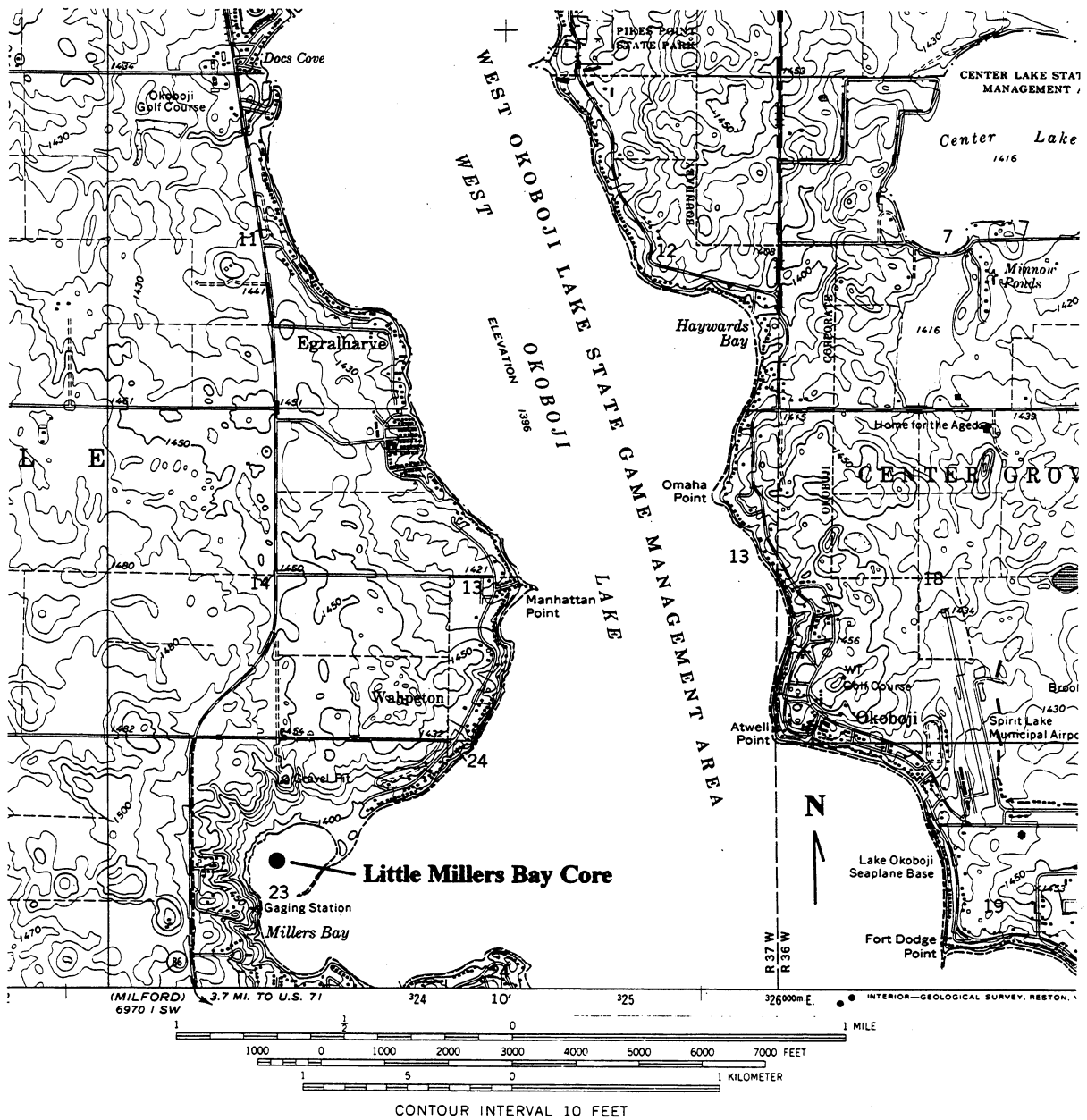
**Origin:** Sediment in the West Okoboji Member is primarily mineral and organic sediment that was deposited from suspension. Minor amounts of fine-grained mineral sediment and sand and pebbles in the member were deposited by *turbidity currents*, ice rafting, and by ice-pushing during periods of low lake levels.

**Age:** The West Okoboji Member dates from the time of the final wastage of glacial ice from the Des Moines Lobe. Deposition has continued to the present, but depositional rates have varied (Van Zant, 1979).

### AN INTERIM LANDFORM CLASSIFICATION FOR THE DES MOINES LOBE

A lithostratigraphic framework for the Lobe's deposits is useful, but of even greater importance is the ability to predict where the various stratigraphic units will occur on the Lobe. Kemmis and others (1981) recognized that different sequences of deposits characterized different landform assemblages in the southeastern part of the Lobe. This ability to predict the sediment sequence with





**Figure 15.** Location of Little Millers Bay core, type section for the West Okoboji Member of the DeForest Formation. The site is located in a projection of West Okoboji Lake, in the Bemis/Altamont Moraine Complex in Dickinson County, Iowa. Base from U.S.G.S. Okoboji 7.5' quadrangle.

depth on the basis of landforms would be a very powerful tool for addressing many landuse issues on the Lobe. Unfortunately, information on the Lobe's subsurface materials is very sparse in many areas and so a detailed relating of landforms to underlying sedimentary sequences is largely precluded at this time.

Not only are the sedimentary sequences that constitute the Lobe's landforms poorly known, but the landscapes are subtle and have complex morphologies which, in most cases, have not been previously recognized. There is also uncertainty about how these landforms relate to classic *end moraines* (including "*hummocky*" topography) and *ground moraines*. Further, existing landform classifications (e.g., Goldthwait, 1975; 1989) do not encompass either the morphologic diversity (landform variety) of the Lobe, or the depositional complexity of modern glacial environments.

With these limitations in mind, Kemmis (1991) developed an interim classification for the complex array of landforms found on the part of the Lobe covered by the Algona advance. A genetic landform classification was avoided because too few sites have been studied, few outcrops expose the entire sequence of deposits, and very few research cores have penetrated the full Des Moines Lobe sequence; hence, the full record of glacial deposition and an interpretation of origin based on field studies is not available for many landforms. Also, because our understanding of processes evolves with time, classifications based on genetic interpretations must continually be revised. Landform morphology does not change, however, and a descriptive classification based on landform morphology remains useful even if the interpreted genesis changes.

## A DESCRIPTIVE CLASSIFICATION

Past classifications emphasized upland glacial landforms as the constructional portion of the landscape and the likely key to depositional history. Aerial photographs also give the impression that uplands dominate the glacial landscape. However, field mapping indicates that drainage/depressional features are an integral, in some cases

dominant, part of the glacial landscape of north-central Iowa, and may be the key to understanding landform genesis. Certain upland morphologies, for example, result because of the geometry of surrounding drainage/depressional features; the genesis of these "upland" landforms, then, is directly related to the origin of the drainage/depressional features.

In the following sections, key aspects of Kemmis' (1991) landform classification are described, and major landform types are introduced. For detailed discussions of the individual landform categories, including their distribution in the areas of the Algona advance, we refer you to Kemmis' 1991 Ph.D. thesis.

### Drainage/Depressional Features

Drainage/depressional features are an integral part of the Des Moines Lobe landscape and must be considered in the interpretation of the Lobe's glacial dynamics and origin of its landforms. Three different categories are recognized: modern drainage lines, abandoned channels and linked-depression systems, and large semi-closed and closed depressions.

#### *Present drainage lines*

Present drainage lines include major river valleys, creeks, and the upper reaches of rivers and creeks that have artificial channels (ditches). Some large, artificially channeled valleys consist of linked depressions. All present drainage lines are valleys incised below the level of the surrounding uplands. Terraces are present in nearly all drainage lines. All present drainage lines on the Lobe connect to the margins of former glacial advances, suggesting they originated as glacial drainageways. Rivers draining to the Missouri River predominantly are associated with the Altamont ice margin, while those draining to the Mississippi River are associated with both the Altamont and Algona margins.

Sedimentary sequences underlying terraces on the Lobe are systematic, but a wide variety of facies are present, and lateral and vertical facies variability are great (Bettis et al., 1988; Kemmis,

1991; Quade, 1992). Regional studies, however, reveal an order to the sequences related to proximity to outwash sediment source, and contrasts between late glacial sequences dominated by coarse-grained sediment (Noah Creek Formation) and Holocene sequences dominated by fine-grained sediments (DeForest Formation).

### ***Abandoned channels and linked-depression systems***

Abandoned channels include former glacial drainageways. Abandoned channels are often connected to, or form part of *linked-depression systems*. Depressions occur throughout the Lobe at all scales from small upland *potholes* a few meters across to major lakes. They are usually not fully closed “*kettles*” (Figure 16A), but have one or more “outlets” across low saddle-like areas (Figure 16B). The saddles separate a chain of depressions that form a valley. This type of valley is called a linked-depression system (Figure 17). The linked-depression systems are analogous to integrated drainages in that smaller, shallower depressions are linked to larger, deeper depressions (Figure 17), although the channel floors in linked-depression systems are not smoothly graded like they are in an integrated drainage network. Most linked-depression systems are branching, rather than linear, and connect present drainage lines. On this larger scale the general surface gradient along a linked-depression valley floor is usually reversed, with gradients toward each present drainage line.

There is a dense concentration of linked-depression systems in “hummocky” areas, and the depressions tend to be large and deep. In low-relief areas there are fewer linked-depression systems, and the depressions tend to be small and shallow.

Cutoff channels occur at several locations along the major rivers draining the Lobe. Abandoned outwash fans and downstream valley trains are associated with all former glacier margins on the Lobe, but are especially well developed along the southern part of the Algona margin.

Sedimentary sequences associated with cutoff channels, abandoned outwash fans, and down-

stream valley trains consist of stratified sand and gravel of the Noah Creek Formation. Sediments associated with linked-depression systems usually consist of variable amounts of generally fine-grained DeForest Formation deposits that overlie resedimented diamictons and associated glaciofluvial sediments of the Dows Formation’s Morgan Member. The Morgan Member deposits usually overlie melt-out till of the Alden Member.

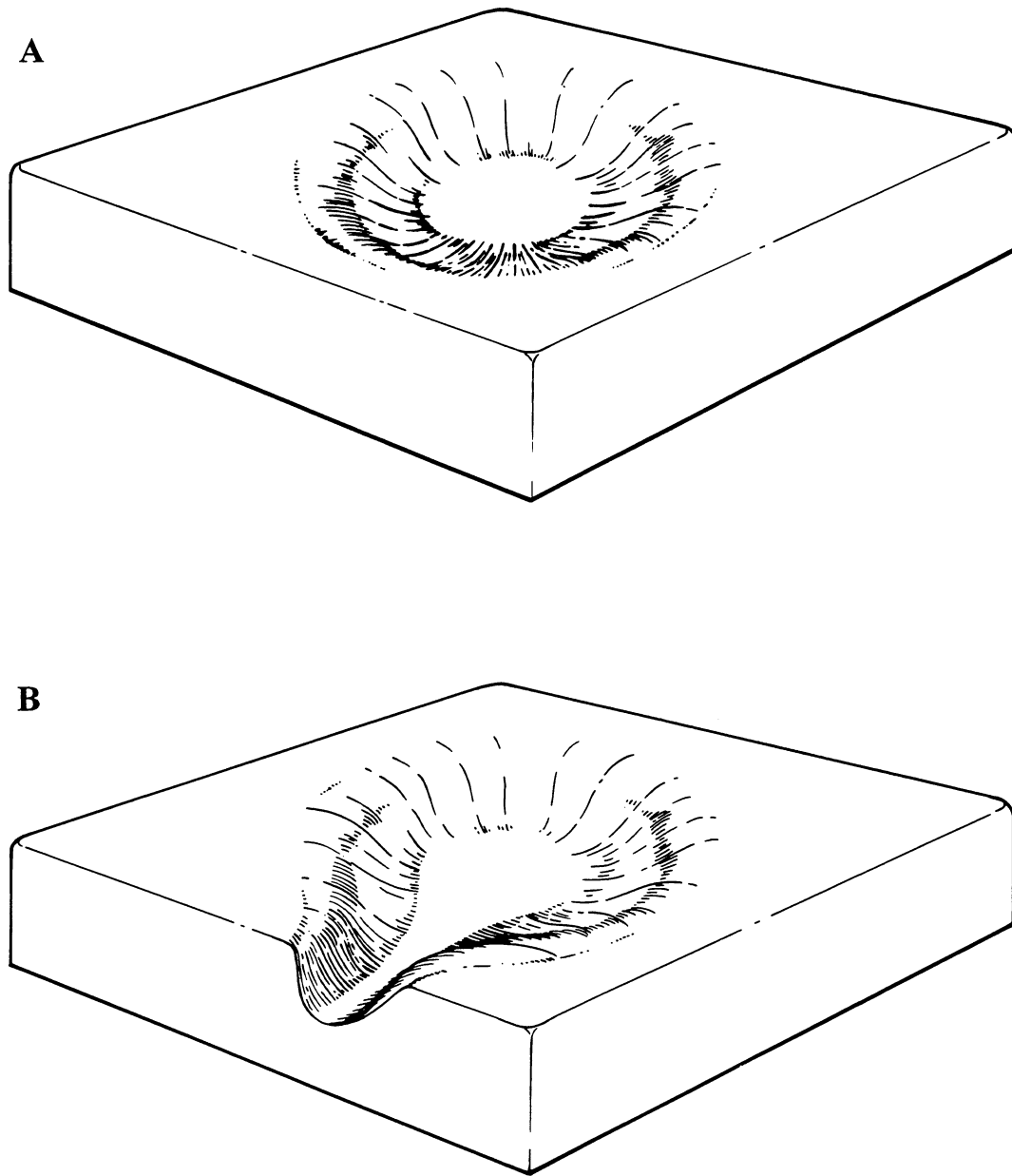
### ***Large semi-closed and closed depressions***

Depressions on the Des Moines Lobe are usually semi-closed (Figure 16B) with at least one outlet to a linked-depression valley (some have more than one outlet which connect the depression into a linked-depression system). Fully closed depressions are rare and appear to have no systematic arrangement.

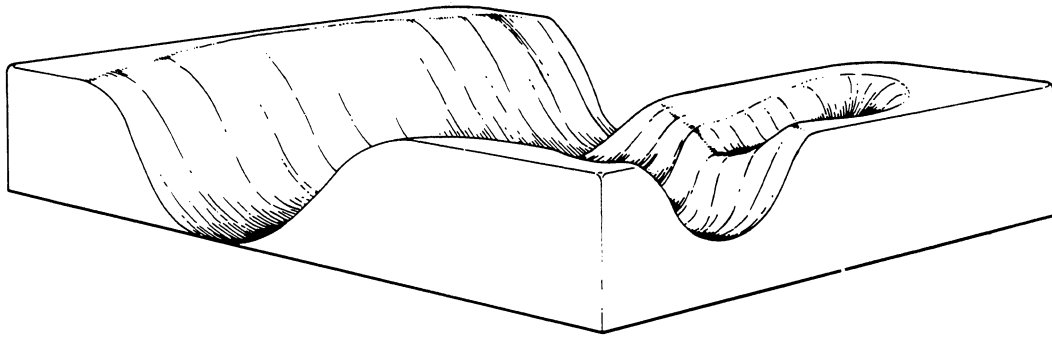
Sedimentary sequences associated with this landform category consist of alternating zones of organic-rich silts, and peats and mucks comprising the Woden Member of the DeForest Formation. The sediments are post glacial and fill several small, coalesced subsurface basins that appear as a larger surface depression. The Woden Member deposits overlie Dows Formation deposits.

## **Upland Landforms**

Uplands on the Lobe are much more complex than implied by the commonly used landform categories “ground moraine” and “end moraine.” Upland landforms vary widely across the area and thus the classification recognizes several general types of large-scale landforms. Two different aspects of the upland landscape are included in the descriptive classification: the land **form** (morphology) and its relief. Mapping categories thus consist of two parts, the landform type and the local relief. As an example, for map category NRS1a, NRS1 denotes the landform type, Non-hummocky Ridge System, and “a” denotes the relief type. Upland landforms are grouped into the following general types that can readily be mapped in the field: ridge systems (type NRS or HRS), escarpments (type NE or HE), hummocky plateaus



**Figure 16.** Types of depressions. A. Fully closed depressions, B. Semi-closed depressions. Upland depressions on the Des Moines Lobe are virtually all semi-closed. Some very large depressions and lakes do not have saddles at their outlets. From Kemmis (1991).



**Figure 17.** Schematic diagram of linked-depression systems. Usually, low “saddles” separate depressions. The linked-depression systems are similar to integrated drainages in that smaller, shallower depressions are linked to larger, deeper depressions. Gradients, however, are not the smooth, graded gradients of integrated drainages. Local “relief” varies with the size and depth of the respective depressions. From Kemmis (1991).

(type HP), ramp-like slopes up to other landforms (type NRR), discontinuous ridges and hummocks, plains (type P<sub>1</sub>), plains with lineated surface patterns transverse to the glacier-flow direction (type PL), and plateau-like plains inset below topographic divides (type PP). Subdivision of these basic types into mapping categories (such as NRS1, NRS2, HRS1, HRS2, HRS3, etc.) is based on differences in surface patterns the landforms exhibit on aerial photographs (e.g., Figure 18). Without the aerial photographs these surface patterns usually are imperceptible and unmappable in the field.

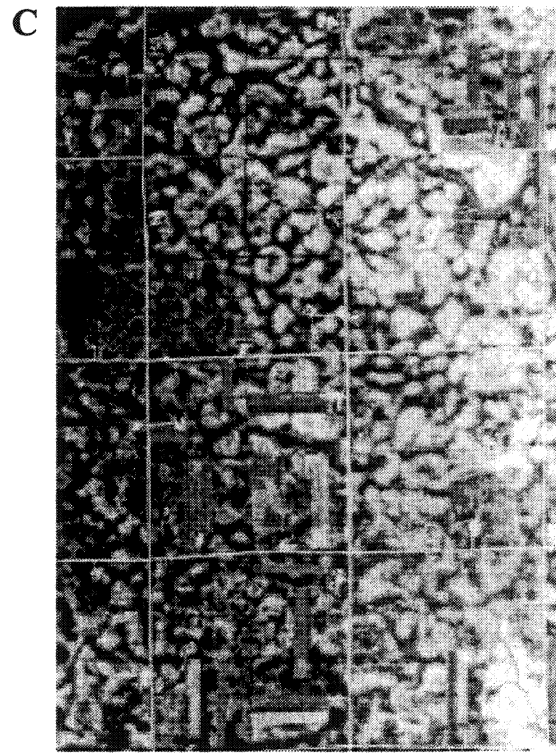
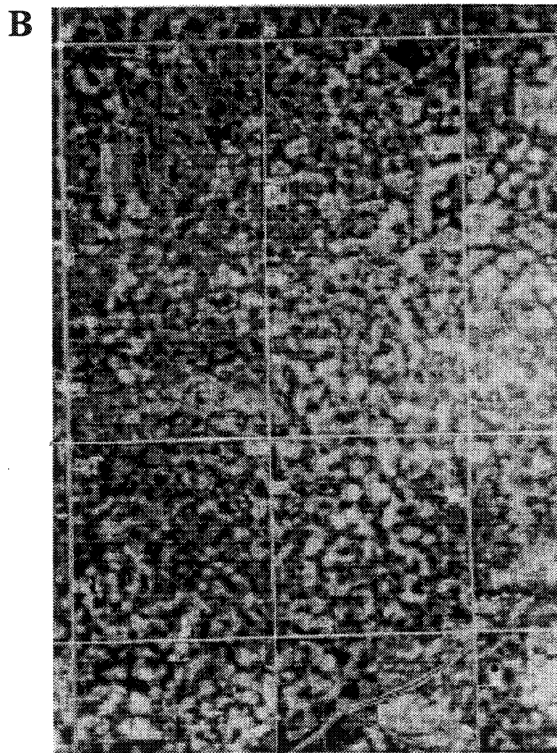
### ***Ridge systems***

Ridge systems (landform types NRS and HRS) are elongate, hilly upland areas with recognizable front and back slopes rising above the surrounding landscape. Ridge systems typically range from 1 to 5 km (1 to 3 miles) in width and extend for many kilometers (miles) although they may be interrupted locally by stream valleys. Ridges have both front and back slopes (Figure 19), distinguishing them from escarpments which are asymmetric and have a steep distal (downglacier) front, but level off to plains on the proximal (upglacier) side. Two types of ridge systems are: non-hummocky ridge systems (type NRS), which have smooth, long slopes dissected by streams, and hummocky ridge

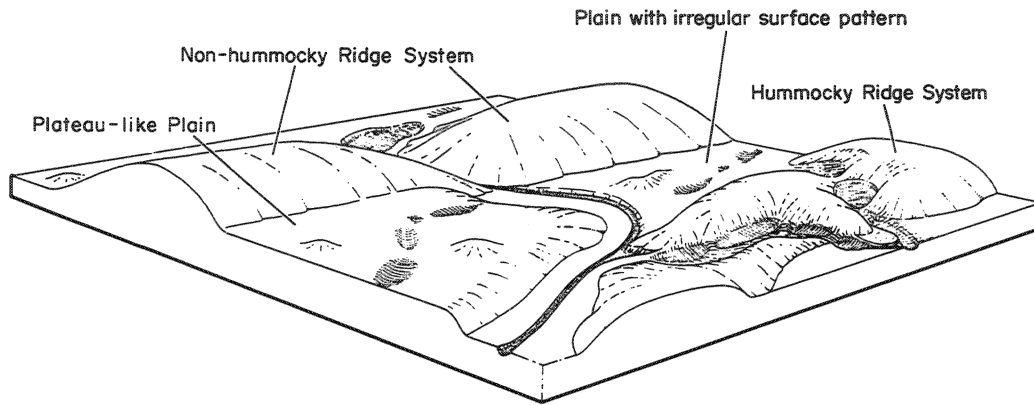
systems (type HRS), which are transected by linked-depression systems, resulting in short, steep slopes that give a “hummocky” appearance to the landscape (Figure 19); the “hummocks” are the positive landscape features bounded and defined by the linked-depression systems.

Ridge systems are one of the principle landforms comprising former ice-marginal areas (“end moraines”), and their origin is important for understanding depositional environments of the Des Moines Lobe. Ridge systems can be complex and the types may change along the extent of former ice margins.

In hummocky areas, Morgan Member deposits are present on hummock flanks and in linked depressions; hummock cores include melt-out till (Alden Member). The geometry of the resedimented materials is away from the hummock core, rather than toward it as in the prevailing model of hummock formation developed by Boulton (1972). Kemmis’ model for the origin of the type of hummocky topography associated with Des Moines Lobe ridge systems involves the presence of a glacial karst system at the same time that melt out till is being slowly released from adjacent debris-rich basal ice following glacier stagnation (Figure 20; Kemmis, 1991). After the ice melts, the karst tunnel system collapses, and supraglacial debris is resedimented into the former tunnel area, now expressed as a linked-depression system.



**Figure 18.** Subdivision of landform types in the study area is based primarily on surface patterns apparent on aerial photographs. Common subdivisions include: A. rounded circular to rounded irregularly shaped surface patterns; B. irregularly shaped surface patterns; and C. irregularly shaped surface patterns with limited areas of rounded irregularly shaped patterns. From Kemmis (1991).



**Figure 19.** Schematic diagram of non-hummocky (landform type NRS) and hummocky (landform type HRS) ridge systems. “Hummocky” areas result from the presence of linked-depression systems. From Kemmis (1991).

### *Escarments*

Escarments are asymmetric, with a steep distal ridge front that levels off at the top (Figure 21). The landform includes the slope forming the ridge front as well as the level plain extending back from the scarp top. Some escarpments have a distinct crest area, while others do not. Non-hummocky escarpments (type NE), like non-hummocky ridge systems, are relatively smooth sided (Figure 21A). In hummocky escarpment areas (type HE; Figure 21B), linked-depression systems are essential components of the landform which, as in hummocky ridge systems, make the topography appear “hummocky.” Individual hummocky escarpments occur on a very large scale, covering hundreds of square kilometers (tens to hundreds of square miles). This large scale makes them recognizable only during detailed regional mapping; otherwise, local relief (usually 10 to 30 m—30 to 100 ft) prevents one from seeing the escarpment form, and one has the impression of driving up, down, and through an area of hummocks (hills). In actuality, however, the “hummocks” are not positive features lying above the general landscape level. Instead they are outlined by the reticulate pattern of interconnected, multi-level depressions and drainageways (linked-depression systems) lying below the general escarpment surface, and the resulting “hummocky” relief is defined by the

depth of the linked depressions below the general plain defining the escarpment top.

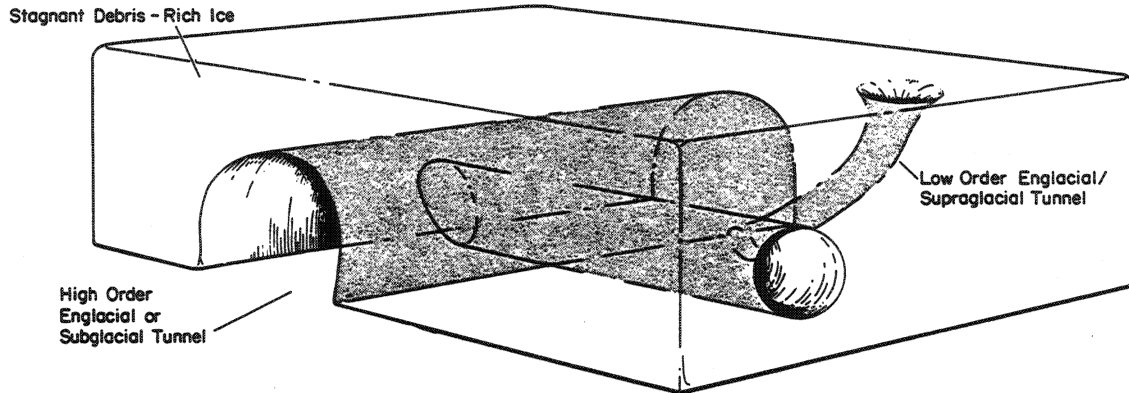
Escarments, together with ridges, comprise the complex landscapes marking former ice margins on the Des Moines Lobe. Stratigraphic sequences studied in hummocky escarpment areas consist of a 2-4 meter thick veneer of Morgan Member deposits, with Alden Member “cores” in hummocks, similar to sequences in hummocky ridge areas. In non-hummocky escarpment areas, Morgan Member deposits are thin to absent and uniform diamicton of the Alden Member is near the land surface.

### *Hummocky plateaus*

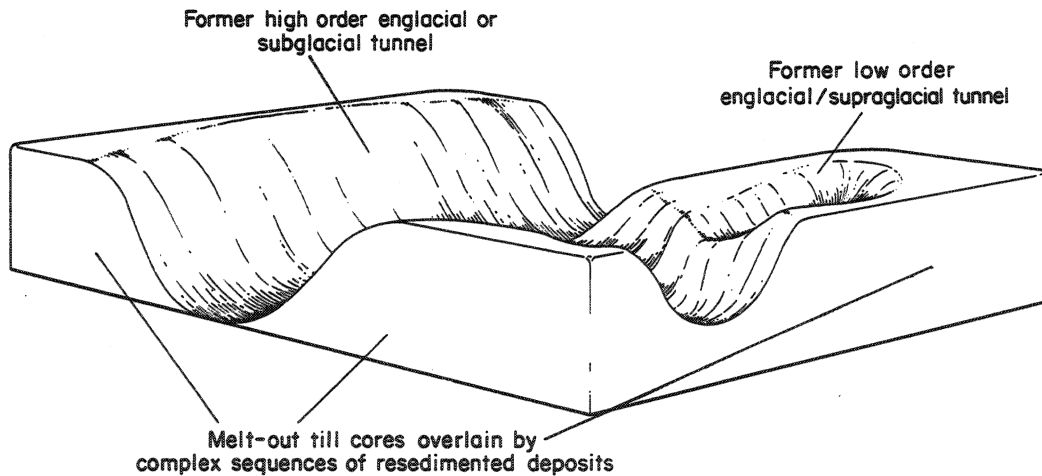
Hummocky plateaus (type HP) are transected by linked-depression systems that create the impression of “hummocky” topography (Figure 22); the tops of the hummocks occur at about the same elevation and define the general plateau level, similar to the area behind the ridge front in hummocky escarpments. Hummocky plateaus occur in intermediate elevation positions bounded by other upland landforms. Hummocky plateaus, like hummocky escarpments, occur on very large scales.

Hummocky plateaus occur just behind, but not right at, former ice-marginal areas. Sedimentary sequences associated with this landform category consist of a 2-4 meter thick veneer of Morgan

**A**

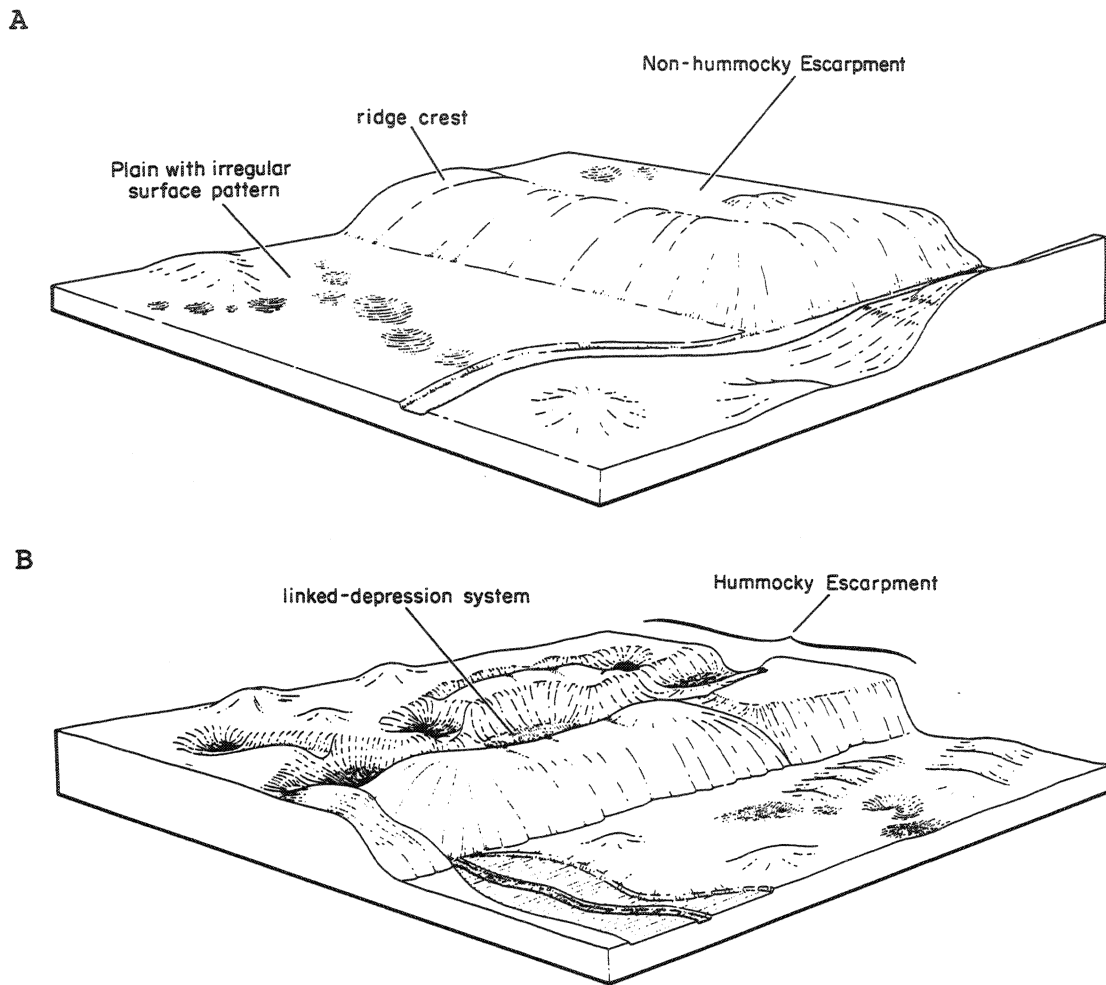


**B**



**Figure 20.** Kemmis' model for the development of "hummocky" glacial topography associated with ridge systems on the Des Moines Lobe. A. The glacier has stagnated. Underlying the glacier are deposits formed during active ice advance. A glacial karst system develops in the ice and sediment is largely washed from the tunnel, although some stratified sediment may be deposited on the channel floor. At the same time, melt-out till is slowly released from adjacent debris-rich ice and supraglacial sedimentation occurs where debris melts out onto the glacier surface. B. The ice has melted away and a complex stream valley/linked-depression system has developed where the former glacial-karst tunnel system was located. When the tunnel system collapsed, unstable debris was resedimented into the former tunnel area. Any supraglacial deposits were let down, draping the underlying deposits.





**Figure 21.** Schematic diagrams of escarpment types. A. Non-hummocky escarpments (landform type NE); B. Hummocky escarpments (landform type HE). “Hummocky” areas are distinguished by the presence of linked-depression systems. From Kemmis (1991).

Member deposits, and cores of Alden Member in hummocks. The stratigraphic sequence is similar to that associated with hummocky ridge systems, and the two landform types appear to have a similar origin.

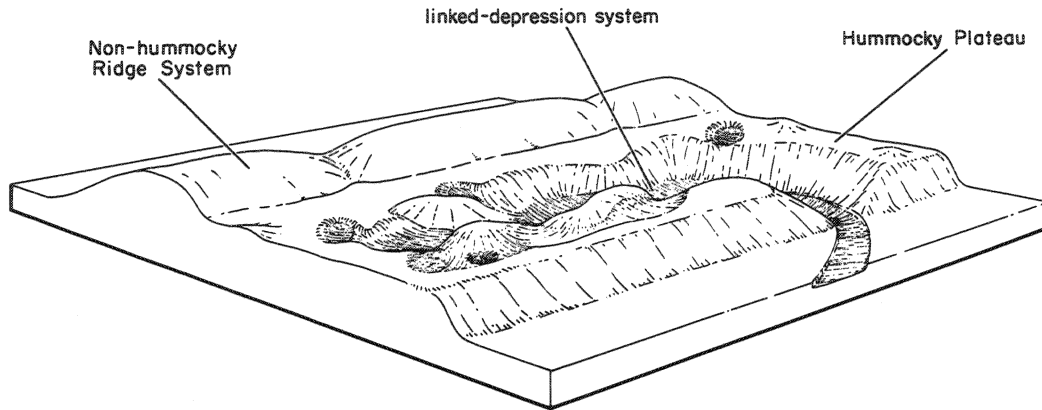
### ***Ramps***

Ramp-like slopes (type NRR) occur in only restricted areas such as a north-south trending portion of south-central Hancock County where a broad, gently sloping landscape 2 to 4 kilometers

(1 to 2 miles) long leads from the broad plains on the west up to a crest overlooking the linked-depression system that constitutes a reach of the West Branch of the Iowa River. The sedimentary sequence associated with ramps has not been studied.

### ***Discontinuous ridges and isolated hummocks***

Discontinuous ridges and isolated hummocks occur on all of the categories mapped as plains. Their location and form are not related to linked-



**Figure 22.** Schematic diagram of a hummocky plateau (landform type HP). “Hummocky” areas are distinguished by the presence of linked-depression systems. In this landform category the tops of the “hummocks” occur at about the same elevation, defining a plateau surface. From Kemmis (1991).

depression systems. Discontinuous ridges are rarely over 3 km (2 mi) long and usually occur as solitary features on plains. Isolated hummocks are individual hills, usually smaller than discontinuous ridges. They do not occur in groups or have recognizable trends.

One site where this landform category has been studied is an isolated hummock on a plateau-like plain formed by the Altamont glacial advance in south-central Palo Alto County (74 Mallard SW section in Kemmis, 1991). The sedimentary sequence at that site consists of thick resedimented diamictos and interbedded glaciofluvial sediments of the Morgan Member. Bedding plane dip directions in the section suggest that the landform developed in a supraglacial environment as described by Boulton (1972), wherein sediment is deposited in low areas on the glacier surface, which, when adjacent ice cores melt out, becomes topographically inverted to form a hummock. Other sites on the Des Moines Lobe show similar stratigraphic sequences.

### *Plains*

These are broad, extensive areas of moderate-to-low relief and long slopes. Plains have a wide variety of surface patterns evident on aerial photographs and they are the most extensive landform type, covering an area almost equal to that of all

other landforms combined. Plains occur behind (upglacier of) landforms interpreted to constitute former ice margins. All of the plain areas are crossed by stream valleys and linked-depression systems and have discontinuous ridges and hummocks randomly present.

Five different types of plains are distinguished which do not have lineated surface patterns transverse to the glacier-flow direction (i.e., do not have “washboard moraine” patterns). Type PR plains have rounded circular to rounded irregularly shaped surface patterns. Type PU plains have irregular surface patterns. Type PS have generally irregular surface patterns, but with limited areas of rounded, irregularly shaped surface patterns. Type PD plains have generally irregular surface patterns and very low relief, reticulate linked-depression systems. Type PH also have generally irregular surface patterns, but rounded circular, flat-topped hummocks are set on the plain surface. Except for the flat-topped hummocks of Type PH, surface patterns on the plains are not distinguishable in the field because the relief is too low. Discontinuous ridges and isolated hummocks occur throughout the areas mapped as plains, and linked-depression systems join together many of the major stream valleys, forming an interconnected drainage network across the areas.

Many plains have lineated surface patterns (on aerial photographs) that are transverse to the gla-

ciér-flow direction (type PL; Figure 23). Although the lineated surface patterns usually are too low in relief to be mapped in the field, plains with these features are designated as a separate type, and the trends have been mapped from aerial photographs.

Plateau-like plains (type PP) are similar to other plain categories except that they occur in a plateau-like position bounded by other upland landforms (Figure 20).

Few outcrops occur in the low-relief plain areas, and few sites have been studied. Localities studied to date show a wide variety of sedimentary sequences including a veneer of Morgan Member, or Lake Mills Member overlying the Alden or Morgan members.

### Relief

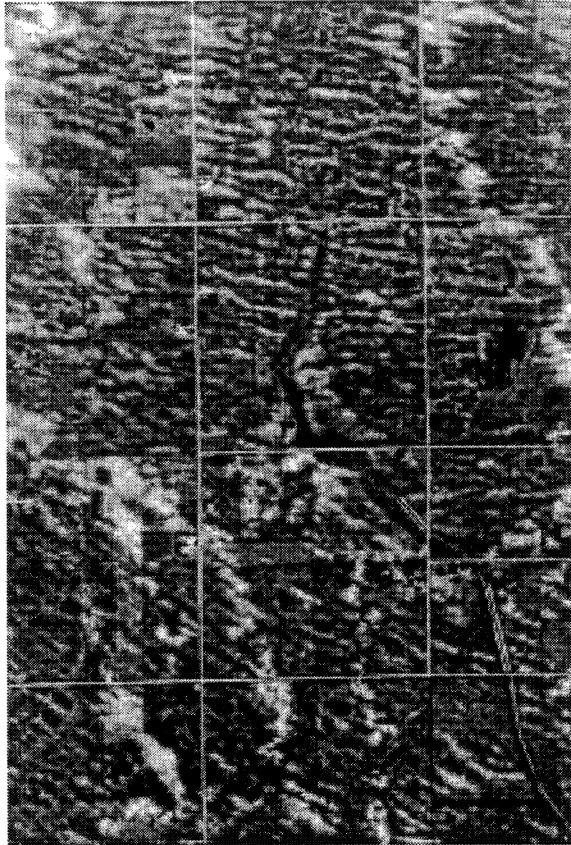
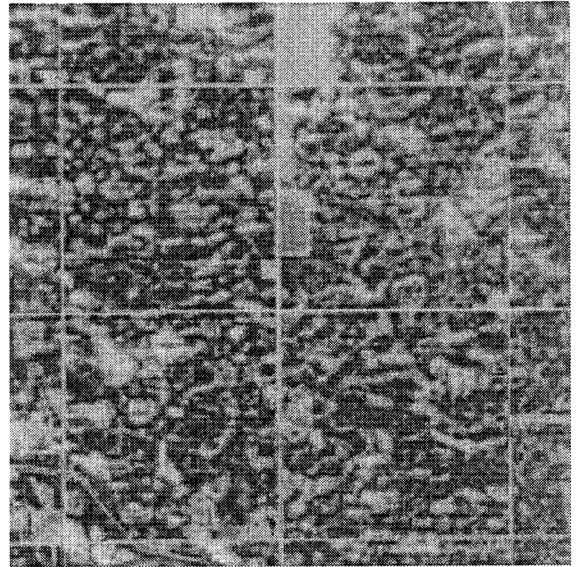
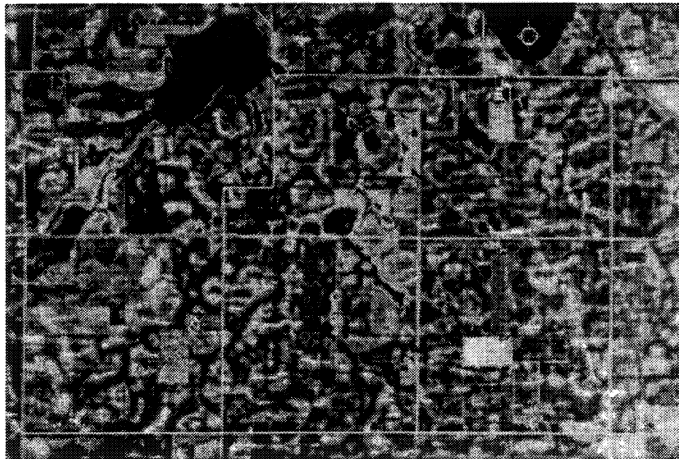
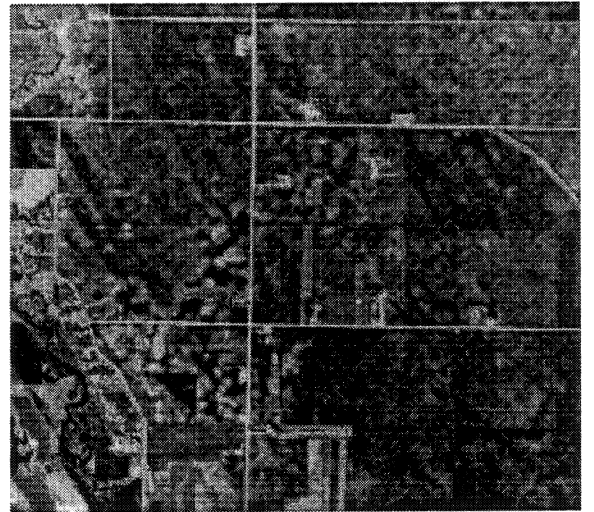
The other readily definable morphologic character of upland landforms is relief. Landform features otherwise similar in morphology may vary greatly in height and slope (relief). Relief has been characterized in many different ways. Clayton and Moran (1974) and Clayton et al. (1980) refer to slope classes (in percent slope) for glacial landforms in North Dakota, but the classes refer only to *backslope* angles and ignore the other *hillslope components* (Ruhe, 1960) making up the landscape. Gravenor and Kupsch (1959) proposed a simple categorization of total relief: high-relief areas—greater than 25 ft (8 m); moderate-relief areas—10 to 25 ft (3 to 10 m); and low-relief areas—less than 10 ft (less than 3 m). However, it proved inadequate to describe important relief differences between landforms of the Des Moines Lobe because slope length is also an important factor. The difference between “hummocky” and “non-hummocky” areas is marked in large part by backslope length: hummocky areas have short backslopes while non-hummocky areas have long backslopes. Thus, some moderate-relief hummocky areas have up to 8 m of relief with short backslopes extending a few hundred meters (a few hundred yards) or less, while many plains have similar **total** relief, but backslopes may extend for as much as a kilometer (over one-half mile) or more.

Relief (slope height, length) for the map categories is denoted by lower case letters, and grouped into Gravenor and Kupsch's (1959) relief classes [e.g., NRS1a—landform category NRS1 (non-hummocky ridge system, NRS1a, with surface patterns that grade from rounded circular to rounded irregular shapes, NRS1a,) and relief category “a” (high relief—>8m—and long slopes)]. Mappable areas of natural landscapes show a complete gradation from long-slope to short-slope categories, and this gradation is reflected in the relief categories needed to describe landforms of the Lobe. Relief categories of landform areas are not discussed in detail in this guidebook and are not indicated in the roadlog. We refer you to Kemmis (1991) for further discussion of relief categories and map units that distinguish relief categories.

### A FRAMEWORK FOR UNDERSTANDING THE DES MOINES LOBE

The kind, distribution, and origin of landform types and recent interpretations of paleoclimate provide a new conceptual framework for the glacial dynamics of the Des Moines Lobe. For the past 100 years, glacial landforms of the Lobe have been mapped as end moraine and ground moraine like other glaciated lobes of the northern United States (Flint, 1959). Since the first regional investigations by Chamberlin (1878; 1883), these landforms have usually implied traditional concepts of active glacial advance and retreat. A recent paper by Clayton et al. (1985) suggests advance and retreat took place very rapidly, and called the successive advance-retreat cycles “surges.”

The categories of end moraine and ground moraine do not adequately describe the complex landforms of the Des Moines Lobe, however, and the stratigraphic sequences do not indicate active-ice sedimentation during the final phases of glaciation. Along former ice-marginal (“end moraine”) areas, landforms change and include several types of hummocky and non-hummocky ridges and escarpments. Behind these ice-marginal zones (in “ground moraine” areas), the distribution of upland landforms is not the systematic or symmetric

**A****B****C****D**

**Figure 23.** Aerial photographs of different types of lineated patterns transverse to the glacier-flow direction. A. well-defined surface patterns (landform type PL3); B. faint, indistinct surface patterns (landform type PL1); C. faint, indistinct surface patterns inset on rounded circular to rounded irregularly shaped plain surfaces (landform type PL2); and D. lineated depressions (landform type PL4). From Kemmis (1991)

arrangement expected from an actively receding glacier, and there is no evidence to indicate retreat of active ice. At almost all studied localities the upper depositional sequence is composed of deposits from stagnant-ice environments (resedimented diamictos and interbedded sorted sediment, deposits from ice-walled lakes, etc.). Landforms of drainage/depressional areas do not indicate active-ice retreat either. Linked-depression systems connect all the major stream valleys resulting in a complexly interconnected drainage network. The linked-depression systems have been interpreted to result from the development and collapse of a glacial-karst system in stagnant ice; glacial-karst systems do not develop in actively moving ice because compressive stresses inhibit pervasive tunnel development. Although the size, depth, and density of linked-depression systems is greatest in former ice-marginal areas, the systems extend across the entire area of each advance. As a consequence, the Des Moines Lobe is interpreted to have stagnated on a regional scale for the glacial karst system to have developed across this whole area. Both drainage/depressional and upland landforms, then, clearly indicate regional stagnation following each advance.

Paleoclimatic interpretations provide additional clues for understanding the dynamics of the Des Moines Lobe. During the past 15 years, paleoenvironmental studies (based primarily on fossil pollen, plant remains, molluscs, and insects) have unfolded the general climatic conditions in the upper Midwest during the Wisconsinan Episode (Baker et al., 1986; 1989; 1990; Schwert, 1992). Arctic conditions and tundra vegetation occurred from about 21,000 to 16,500 RCYBP. Shortly after 16,500 RCYBP the climate ameliorated and a succession of conifer and conifer-hardwood forests occupied Iowa up to the beginning of the Holocene at 10,500 RCYBP (Van Zant, 1979; Kim, 1986). Yet at about 14,000 RCYBP, in the midst of the warming trend, the Des Moines Lobe made its furthest southern advance, and episodic advances continued into Iowa until at least 12,500 RCYBP. Based on the radiocarbon chronology and paleoclimatic interpretations, Des Moines Lobe glacial advances were out of phase

with climate and out of phase with the advances of lobes to the east.

### A NEW MODEL FOR THE DES MOINES LOBE

Glaciers which make rapid, climatically out-of-phase advances and then stagnate are a distinctive kind of glacier, a surging glacier (Sugden and John, 1976; Paterson, 1981). A surging-glacier model provides a new framework for understanding the dynamics of the Des Moines Lobe that, coupled with the landform-sediment assemblages described herein, can be used to predict the nature of glacial deposits on the Lobe. Near-surface deposits on the Lobe consist of one of the complicated sedimentary successions associated with stagnant ice, and landform assemblages are complex, and related to local stagnation conditions, rather than to systematic, active glacial retreat.

This model differs from that of Clayton et al. (1985) which, unlike known surging glaciers, required rapid glacial retreat. Glaciers make rapid advances during a surge, becoming unusually thin (Paterson, 1981); stagnation follows because the thin ice and low surface profiles prohibit further active movement. Later surge advances may occur if ice builds up in the reservoir area (the main ice sheet, in this case). The low glacier-profile reconstructions for the Des Moines Lobe (Mathews, 1974) are supported by this model; Clayton et al. (1985) cited these profile reconstructions as evidence for surging, primarily to explain radiocarbon chronologies that they believed required rapid advance and retreat. However, the radiocarbon chronologies are more easily explained by repeated surge advances from the main Laurentide ice sheet and melting of thin stagnant ice, rather than by unusually rapid glacial recessions that do not accompany surges of modern glaciers. The type, distribution, and sedimentology of glacial landforms on the Des Moines Lobe are explained by regional stagnation, not rapid recession.

## REFERENCES

- Baker, R.G., Chumbley, C.A., Witinok, P.M., and Kim, H.K., 1990, Holocene vegetational changes in eastern Iowa: *Journal of the Iowa Academy of Science*, v. 97, p. 167-177.
- Baker, R.G., Rhodes, R.S. II, Schwert, D.P., Ashworth, A.C., Frest, T.J., Hallberg, G.R., and Janssens, J.A., 1986, A full-glacial biota from southwestern Iowa, USA: *Journal of Quaternary Science*, v.1, p. 91-107.
- Baker, R.G., Sullivan, A.E., Hallberg, G.R., and Horton, D.G., 1989, Vegetational changes in western Illinois during the onset of late Wisconsinan glaciation: *Ecology*, v. 70, p. 1363-1376.
- Banerjee, J. and McDonald, B.C., 1975, Nature of esker sedimentation, *in* Jopling, A.V. and McDonald, B.C., eds., *Glaciofluvial and Glaciolacustrine Sedimentation: Society of Economic Paleontologists and Mineralogists, Special Publication No. 23*, p. 132-154.
- Bettis, E.A., III, 1990, Holocene alluvial stratigraphy of western Iowa, *in* Bettis, E.A., III, ed., *Holocene alluvial stratigraphy and selected aspects of the Quaternary history of western Iowa: Midwest Friends of the Pleistocene Field Trip Guidebook*, p. 1-72.
- Bettis, E.A., III, and Hoyer, B.E., 1986, Late Wisconsinan and Holocene landscape evolution and alluvial stratigraphy in the Saylorville Lake area, central Des Moines River Valley, Iowa: *Iowa Geological Survey Open File Report 86-1*, 71 p.
- Bettis, E.A., III, Baker, R.G., Green, W., Whelan, M.K., and Benn, D.W., 1992, Late Wisconsinan and Holocene alluvial stratigraphy, paleoecology, and archeological geology of east-central Iowa: *Iowa Department of Natural Resources-Geological Survey Bureau Guidebook Series No. 12*, 82 p.
- Bettis, E.A., III, Pearson, J., Edwards, M., Gradwohl, D., Osborn, N., Kemmis, T., and Quade, D., 1988, Natural history of Ledges State Park and the Des Moines Valley in Boone County: *Geological Society of Iowa Guidebook 48*, 71 p.
- Boulton, G.S., 1972, Modern Arctic glaciers as depositional models for former ice sheets: *Quart. Jour. of the Geological Society of London*, v. 128, p. 361-393.
- Burras, C.L. and W.H. Scholtes, 1987, Basin properties and postglacial erosion rates of minor moraines in Iowa: *Soil Science Society of America Journal*, v. 51, p. 1541-1547.
- Chamberlin, T.C., 1878, On the extent and significance of the Wisconsin Kettle Moraine: *Transactions of the Wisconsin Academy of Sciences, Arts, and Letters*, v. 4, p. 201-234.
- Chamberlin, T.C., 1883, Preliminary paper on the terminal moraine of the second glacial epoch: *U.S. Geological Survey Third Annual Report*, p. 291-402.
- Church, M. and Gilbert, R., 1975, Proglacial fluvial and lacustrine environments, *in* Jopling, A.V., and MacDonald, B.C., eds., *Glaciofluvial and Glaciolacustrine Sedimentation: Society of Economic Paleontologists and Mineralogists Special Publication No. 23*, p. 22-100.
- Clark, P.U., 1991, Striated clast pavements: products of deforming subglacial sediment?: *Geology*, v. 19, p. 530-533.
- Clayton, L., and Moran, S.R., 1974, A glacial process-form model, *in* Coates, D.R., ed., *Glacial Geomorphology: Binghamton, New York*, p. 89-119.
- Clayton, L., Moran, S.R., and Bluemle, J.P., 1980, Explanatory text to accompany the geologic map of North Dakota: *North Dakota Geological Survey Report of Investigations*, v. 69, 93 p.
- Clayton, L., Teller, J.T., and Attig, J.W., 1985, Surging of the southwestern part of the Laurentide Ice Sheet: *Boreas*, v. 14, p. 235-241.
- Croot, D.G., 1978, The depositional landforms and sediments produced by two surging glaciers: *University of Aberdeen (Scotland)*, unpublished Ph.D. thesis, 354 p.
- Daniels, R.B., Rubin, M., and Simonson, G.H., 1963, Alluvial chronology of the Thompson Creek Watershed, Harrison County, Iowa: *American Journal of Science*, v. 261, p. 473-484.
- Daniels, R.B., and Handy, R.L., 1966, Surficial sediments on undulating Cary ground moraine in central Iowa: *Iowa State University Engineering Research Institute Technical Report 3*, 20 p.
- Flint, R.F., 1959, Glacial map of the United States east of the Rocky Mountains: scale 1:750,000: *Geological Society of America: 2 Sheets*.
- Flint, R.F., 1971, *Glacial and Quaternary Geology*: John Wiley & Sons New York, 892 p.
- Fullerton, D.S., 1986, Stratigraphy and correlation of glacial deposits from Indiana to New York and New Jersey, *in* Richmond, G.M. and Fullerton, D.S., eds., *Quaternary Glaciations in the United States of*



- America, *in* Sibrava, V., Bowen, D.Q., and Richmond, G.M., eds., *Quaternary Glaciations in the Northern Hemisphere: Quaternary Science Reviews*, v. 5, p. 23-37.
- Goldthwait, R.P., 1975, *Glacial Deposits*: Dowden, Hutchinson & Ross, Stroudsburg, PA, 464 p.
- Goldthwait, R.P., 1989, Classification of glacial morphologic features, *in* Goldthwait, R.P., and Matsch, C.L., eds., *Genetic Classification of Glacigenic Deposits*: A.A. Balkema, Rotterdam p. 267-277.
- Graeff, R. W., 1986, Glaciolacustrine sedimentation in southeastern Winnebago County, Iowa: University of Iowa Department of Geology, Iowa City, unpublished M.S. thesis, 208 p.
- Gravenor, C.P., and Kupsch, W.O., 1959, Ice-disintegration features in western Canada: *Journal of Geology*, v. 67, p. 48-64.
- Hallberg, G.R., 1980, Pleistocene stratigraphy in east-central Iowa: Iowa Geological Survey Bureau, Technical Information Series No. 10, 168 p.
- Hallberg, G.R. and Kemmis, T.J., 1986, Stratigraphy and correlation of the glacial deposits of the Des Moines and James Lobes and adjacent areas in North Dakota, South Dakota, Minnesota, and Iowa *in* Richmond, G.M. and Fullerton, D.S., eds., *Quaternary Glaciations in the United States of America* *in* V. Sibrava, D.Q. Bowen, and G.M. Richmond, eds., *Quaternary Glaciations of the Northern Hemisphere: Quaternary Science Reviews*, v. 5, p. 11-16.
- Hallberg, G.R., Wollenhaupt, N.C., and Wickham, J.T., 1980, Pre-Wisconsinan stratigraphy in southeast Iowa, *in*, Hallberg, G.R., ed., *Illinoian and Pre-Illinoian stratigraphy of southeast Iowa and adjacent Illinois*: Iowa Geological Survey Bureau, Technical Information Series No. 11, p. 1-110.
- Hoyer, B.E., 1980, Geomorphic history of the Little Sioux River Valley: *Geological Society of Iowa Guidebook* 34, 94 p.
- Johnson, W.H., 1986, Stratigraphy and correlation of the glacial deposits of the Lake Michigan Lobe prior to 14 ka BP, *in* Richmond, G.M. and Fullerton, D.S., eds., *Quaternary Glaciations in the United States of America*, *in* Sibrava, V., Bowen, D.Q., and Richmond, G.M., eds., *Quaternary Glaciations of the Northern Hemisphere: Quaternary Science Reviews*, v. 5, p.17-22.
- Kemmis, T.J, Bettis, E.A. III, and Quade, D.J., 1994, The Des Moines Lobe in Iowa: a surging Wisconsinan glacier: *American Quaternary Association, Program and Abstracts*, 13th Biennial Meeting, Minneapolis, p. 112.
- Kemmis, T.J. Hallberg, G.R. and Lutenecker, A.J., 1981, Depositional environments of glacial sediments and landforms on the Des Moines Lobe, Iowa: *Iowa Geological Survey Guidebook No. 6*, Iowa City, 132 p.
- Kemmis, T.J., 1981, Glacial sedimentation and the Algona Moraine in Iowa: *Geological Society of Iowa Guidebook* 35, 45 p.
- Kemmis, T.J., 1991, Glacial landforms, sedimentology and depositional environments of the Des Moines Lobe, northern Iowa: University of Iowa Department of Geology, Iowa City, unpublished Ph.D. thesis, 393 p.
- Kemmis, T.J., Bettis, E.A., III, and Quade, D.J., 1987, Sedimentary sequences of Wisconsinan-age outwash streams on the Des Moines Lobe in north-central Iowa: *Iowa Academy of Science Program Abstracts*, 99th Annual Meeting, abstract no. 153.
- Kemmis, T.J., Quade, D.J., and Bettis, E.A. III, 1988, Part II, Hallet Gravel Pits, *in* Bettis, E.A. III, et al., *Natural history of Ledges State Park and the Des Moines River Valley in Boone County: Geological Society of Iowa Guidebook* 48, p. 37-71.
- Kim, H.K., 1986, Late glacial and Holocene environment in central Iowa: a comparative study on pollen data from four sites: University of Iowa Department of Geology, unpublished Ph.D. thesis, Iowa City (Dissertation Abstract 86-28118).
- Kruger, J., 1979, Structures and textures in till indicating subglacial deposition: *Boreas*, v. 8, p. 323-340.
- Lawson, D.E., 1979a, Sedimentological analysis of the western terminus region of the Matanuska Glacier, Alaska: *CRREL Report* 79-9, 112 p.
- Lawson, D.E., 1979b, A comparison of the pebble orientations in ice and deposits of the Matanuska Glacier, Alaska: *Journal of Geology*, v. 87, p. 629-645.
- Lawson, D.E., 1989, Glacigenic resedimentation: classification concepts and application to mass-movement processes and deposits, *in* Goldthwait, R.P., and Matsch, C.L., eds., *Genetic Classification of Glacigenic Deposits*: A.A. Balkema, Rotterdam, p. 147-169.
- Lowe, D.R., 1978, Water-escape structures, *in* Fairbridge, R.W., and Bourgeois, J., eds., *The Encyclopedia of Sedimentology*: Dowden, Hutchinson & Ross, p. 864-868.
- Mathews, W.H., 1974, Surface profile of the Laurentide ice sheet in its marginal areas: *Journal of Glaciology*, v. 13, p. 37-43.
- Matsch, C.L., 1972, Quaternary geology of southwestern

- Minnesota, *in* Sims, P.K. and Morey, G.B., eds., *Geology of Minnesota: A Centennial Volume: Minnesota Geological Survey, St. Paul*, p. 548-560.
- McDonald, B.C., and Shilts, W.W., 1975, Interpretation of faults in glaciofluvial sediments, *in* Jopling, A.V., and McDonald, B.C., eds., *Glaciofluvial and Glaciolacustrine Sedimentation*, Society of Economic Paleontologists and Mineralogists Special Publication No. 23, p. 123-131.
- Paterson, W.S.B., 1981, *The Physics of Glaciers*, 2nd edition: Pergamon Press Ltd., Oxford, 380 p.
- Quade, D.J., 1992, *Geomorphology, sedimentology and stratigraphy of Late Wisconsinan valley-train terraces along the Iowa River in north-central Iowa*: University of Iowa Department of Geology, Iowa City, unpublished M.S. thesis, 85 p.
- Ramos, A., and Sopena, A., 1983, Gravel bars in low-sinuosity streams (Permian and Triassic, central Spain): *International Association of Sedimentologists Special Publication No. 6*, p. 301-312.
- Ruhe, R.V., 1956, Geomorphic surfaces and the nature of soils: *Soil Science*, v. 82, p. 441-455.
- Ruhe, R.V., 1960, Elements of the soil landscape: *Transactions of the 7th International Congress of Soil Science*, v. 4, p. 165-170.
- Ruhe, R.V., 1969, *Quaternary Landscapes in Iowa*: Iowa State University Press, Ames, IA, 255 p.
- Saunderson, H.C., 1975, Sedimentology of the Brampton Esker and its associated deposits: an empirical test of theory, *in* Jopling, A.V., and McDonald, B.C., eds., *Glaciofluvial and Glaciolacustrine Sedimentation*, Society of Economic Paleontologists and Mineralogists Special Publication No. 23, p. 155-176.
- Schwert, D.P., 1992, Faunal transitions in response to an ice age: the late Wisconsinan record of Coleoptera in the north-central United States: *Coleopterists Bulletin*, v. 46, p. 68-94.
- Simons, D.B., Richardson, E.V., and Nordin, C.F., Jr., 1965, Sedimentary structures generated by flow in alluvial channels, *in* Middleton, G.V., ed., *Primary Sedimentary Structures and Their Hydrodynamic Interpretation*: Society of Economic Paleontologists and Mineralogists Special Publication No. 12, p. 34-52.
- Smith, N.D., 1985, Chapter 3, Proglacial fluvial environment, *in* Ashley, G.M., Shaw, J., and Smith, N.D., eds., *Glacial Sedimentary Environments*: Society of Economic Paleontologists and Mineralogists Short Course No. 16, p. 85-134.
- Steinwand, A.L., and Fenton, T.E., 1995, Landscape evolution and shallow groundwater hydrology of a till landscape in central Iowa: *Soil Science Society of America Journal*, v. 59, p. 1370-1377.
- Sugden, D.E., and John, B.S., 1976, *Glaciers and Landscape*: New York, John Wiley & Sons, 376 p.
- Van Nest, J., and Bettis, E.A., III, 1990, Postglacial response of a stream in central Iowa to changes in climate and drainage basin factors: *Quaternary Research*, v. 33, p. 73-85.
- Van Zant, K., 1979, Late glacial and postglacial pollen and plant macrofossils from West Lake Okoboji, northwestern Iowa: *Quaternary Research*, v. 12, p. 358-380.
- Walker, P.H., 1966, Postglacial environments in relation to landscape evolution on the Cary drift, Iowa: *Iowa State University Agricultural and Home Economic Experiment Station Research Bulletin 549*, p. 838-875.
- Walker, P.H., and Brush, G.S., 1963, Observations on bog and pollen stratigraphy of the Des Moines glacial lobe, Iowa: *Proceedings of the Iowa Academy of Science*, v. 70, p. 253-260.
- Wallace, R.W., and Handy, R.L., 1961, Stone lines on Cary till: *Proceedings of the Iowa Academy of Science*, v. 68, p. 372-379.
- Willman, H.B., and Frye, J.C., 1970, Pleistocene stratigraphy of Illinois: *Illinois State Geological Survey Bulletin 94*, 204 p.





## GLOSSARY

**Alluvial**—sediments deposited in stream valleys by the action of running water. Also pertains to valley geomorphic settings.

**Backslope**—the often linear component of a hillslope profile that lies below the convexly rounded shoulder and above the concave footslope.

**Colluvial**—sediments deposited by a number of subareal, nonchannel processes including sheetwash, rainsplash, creep, debris flow, and sediment gravity flow. Colluvial sediments are usually found on and at the base of hillslopes.

**Conformable**—strata lying one upon the other in unbroken and parallel order are said to be conformable.

**Deformation (till)**—weak rock or unlithified sediment that has been detached from its source beneath a moving glacier, the primary sedimentary structures distorted or destroyed, and some foreign material admixed.

**Diamicton**—a descriptive term for poorly sorted deposits. In Iowa, diamictons consist of mixtures of sand, silt, clay, pebbles, cobbles, and boulders. Most Iowa diamictons are ‘matrix-supported,’ that is, finer grained matrix material constitutes the greatest volume and surrounds individual pebbles or larger size rock fragments in the diamicton.

**End moraine**—a moraine that marks the greatest extent of a glacial advance. A moraine is a ridge or escarpment composed of drift deposited chiefly by direct glacial action, and having constructional topography independent of control by the surface on which the drift lies.

**Englacial**—contained, embedded, or carried within the body of a glacier.

**Eolian sand**—sand deposited by wind action.

Eolian sand is well sorted and usually dominated by the fine sand fraction. In Iowa eolian sand is included in the Peoria Formation when it occurs on valley slopes and uplands, and in the Noah Creek or Henry formations when it overlies valley train outwash.

**Esker**—an elongate, often serpentine ridge composed of stratified and deformed sand and gravel, sometimes with minor mounts of diamicton beds. Eskers accumulated in englacial and subglacial tunnels through the action of meltwater. Deposits comprising eskers in Iowa are included in the Pilot Knob Member of the Dows Formation.

**Fluvial**—of or pertaining to streams, produced by river action.

**Glacigenic**—a term indicating a relationship to glaciation. For example, sand-and-gravel outwash deposited in streams draining a glacier are not glacial deposits *per se* because they are not deposited directly from the glacier. They are glacigenic, however, because it is glacier meltwater and, in large part, glacier sediment supply that result in their formation.

**Glaciofluvial**—pertaining to meltwater streams flowing from the margins of glaciers or to the alluvial deposits and landforms formed by such streams.

**Ground moraine**—an accumulation of till after it has been deposited or released from the ice during ablation, to form an extensive area of low relief.

**Gyttja**—a sapropelic (originating as an aquatic ooze) black mud in which organic matter is more or less determinable.

**Hillslope components**—the geomorphic components that comprise a hillslope. In descending

order from the top of the slope: summit, shoulder, backslope, footslope, and toeslope.

**Hummocky topography**—topography consisting of randomly arranged knobs (hummocks) that are separated and defined by intervening low-lying areas that are part of linked-depression systems.

**Ice marginal**—geomorphic settings at or near the margin of a former glacier.

**Kame**—a short ridge composed of stratified and deformed sand and gravel, sometimes with minor amounts of diamicton beds, deposited, usually as a steep alluvial fan, against the edge of a glacier by debauching streams of sediment-laden meltwater. Sediments comprising kames in Iowa are included in the Pilot Knob Member of the Dows Formation.

**Kettle**—a depression in drift formed by the melting away of a detached block of ice that was wholly or partially buried in the drift.

**Lithostratigraphic**—referring to a stratigraphic classification that is based on observable rock characteristics including: chemical and mineralogical composition, texture, grain size, bedding structures, color, fossil content, or other organic content.

**Lodgement (till)**—diamicton deposited by plastering of glacial debris from the sliding base of a moving glacier by pressure melting and/or other mechanical processes. Lodgement till is characterized by being massive and dense, with a pebble fabric oriented parallel to the direction of glacier flow.

**Loess**—wind-blown sediment dominated by grains in the silt size fraction. In Iowa most loess originated from wind deflation of valley train outwash.

**Melt-out (till)**—diamicton deposited by a slow release of glacial debris from ice that is not sliding or deforming internally. Melt-out till is

similar to lodgement till, but may contain debris banding and clasts of unlithified sediments.

**Moulin**—a depression on the surface of a melting glacier into which meltwater funnels. Moulins are the surface inlets of a glacial karst system.

**Paleosol**—a former soil; usually buried by younger deposits.

**Paludal**—pertaining to fen, bog, and marsh wetlands and to the sediments deposited in them.

**Pothole**—a closed or semi-closed depression.

**Striated clast pavement**—clasts of rock (cobbles, boulders, and pebbles) concentrated at the basal contact of a glacial diamicton that have been striated (scraped and etched) by rock fragments carried at the base of an overriding glacier.

**Subglacial**—formed or accumulated in or by the bottom parts of a glacier or ice sheet. Pertaining to the area immediately beneath a glacier.

**Supraglacial**—on the surface of a glacier. Also refers to diamictons that accumulated in a supraglacial environment through a variety of processes (also known as flowtills). Supraglacial sediment has usually undergone a series of resedimentation events producing various degrees of sorting, deformation (from both meltout of underlying ice and sediment loading), and a wide range of bedding structures. The Morgan member of the Dows Formation is interpreted as supraglacial sediment.

**Till**—sediment released directly from the glacial ice that has not undergone subsequent disaggregation and resedimentation. Till can form by several different glacial processes, including lodgement, melt-out, and deformation. Till on the Des Moines Lobe is usually massive, dense diamicton without any fissility (subhorizontal partings) or other recognizable

deformation structures.

**Turbidity current**—a highly turbid and dense current which moves along the bottom slope of a standing body of water (also called a density current).

**Varve couplets**—a pair of contrasting laminae representing seasonal sedimentation in a lake where thermal stratification and turnover occurs. Usually the part of the couplet deposited during the summer is light colored and the winter part of the couplet is darker.



**DES MOINES LOBE (DML)  
ROAD LOG**



## DES MOINES LOBE (DML) ROAD LOG

Acc. Mileage (miles)	Distance (miles)	Notes
<b>Day 1 Log</b>		
0	0	Trip departs from north parking lot of the Scheman Building. Turn right onto Elwood Dr. and proceed south toward US Hwy. 30.
1.2	1.2	Turn right onto ramp to US Hwy. 30. Proceed west. To the left is the Gateway Center. "Minor moraines" are present in this area and large parts of the southern and central parts of the DML. This is a plain with lineated surface patterns transverse to the glacier flow-direction (category PL) in Kemmis' (1991) landform classification. The small curvilinear ridges on this plain are generally 1-2 m in relief and composed of dense basal diamicton (Alden Mbr.) with strongly oriented pebble fabrics, sometimes overlain by a thin drape of resedimented diamicton or sorted sediments (Morgan Mbr.). Flanks of the ridges are mantled by thin deposits of fine-grained colluvium which is included in the Flack Mbr. of the DeForest Fm. The slope deposits grade to undifferentiated DeForest Fm. alluvium in the swale areas. At Stop 1 we will discuss the stratigraphy of this type of landscape.
8.4	7.2	<p>To the left (south) is the Ames Till Hydrology Site (ATHS), located on the ISU Agronomy Research Farm. The Aquitard Hydrology Project was designed to develop improved methods for characterizing the hydrogeologic properties of fine-grained tills and to compare new, innovative technologies and techniques with traditional ones. As part of the Iowa Groundwater Protection Act of 1987, special funding was dedicated to these studies. Further support by Iowa State University, the Leopold Center, and grants to a number of investigators have facilitated the extensive instrumentation and development of this research site.</p> <p>Data from this study confirm that the ATHS is underlain by Dows Fm. till, Peoria Silt, Pre-Illinoian till, and Pennsylvanian sandstone (Cherokee Group). At the time of the Des Moines Lobe ice advance into this area at about 14,000 years B.P., a coniferous forest was growing on the Peoria Loess. As the glacier advanced it buried the forest and entrained particulate organic material which was later deposited in the basal till (Alden Mbr. of the Dows Fm.). Spruce logs and blocks of organic material are common at the top of the loess and in the overlying till. Carbon-14 ages of these organic remains indicate that the upper part of the Peoria Loess in central Iowa dates from 17,000 to 14,000 B.P.</p> <p>Hydrogeologic studies at the ATHS used determinations of hydraulic head, hydraulic gradient, and hydraulic conductivity in</p>



several geologic units, in addition to isotopic dating techniques, particularly  $^{14}\text{C}$ , to determine the potential for groundwater contamination of underlying aquifers (Simpkins et al., 1993). A total of 46 piezometers, ranging in depth from 3 to 128 m (10 to 421 ft.), were installed in Dows Fm. diamicton, Peoria Loess, Pre-Illinoian diamicton and gravel, and Pennsylvanian sandstone.

Hydraulic heads were measured monthly in piezometers and hydraulic conductivities of the units were determined in order to estimate the velocity of groundwater at the site. Groundwater age was determined using atmospherically derived tracers -- tritium,  $^{14}\text{C}$ , and  $\delta^{13}\text{C}$  ( $^{13}\text{C}/^{12}\text{C}$ ) of dissolved organic carbon.

Hydrogeologic investigations determined that the near-surface groundwater in the oxidized weathering zone of Dows Fm. diamicton is quite young, and that water at the base of the Peoria Loess is less than 300 years old. Groundwater age increases to about 14,000 B.P. in the Pre-Illinoian till. Hydraulic gradients are primarily vertical with low head gradients in unoxidized Dows Fm. diamicton (Alden Mbr.) and loess; however the underlying Pre-Illinoian diamicton has vertical gradients greater than 1.0. The highest potential for groundwater contamination therefore exists in the oxidized till of the Dows Fm.

Simpkins and others (1993) also noted high concentrations of  $\text{CH}_4$  (30-43 mg/L) in the Dows Fm. diamicton and underlying loess sequence that were attributed to low redox conditions that exist today in the diamicton below 4 meters. Simpkins and others (1993) attributed the origin of these high  $\text{CH}_4$  concentrations to microbial processes; methanogens utilizing buried particulate organic carbon derived from the coniferous forest growing on the loess at the time the glacier advanced into the region.

The results of the ATHS investigations have important implications for evaluating water quality impacts of agriculture in this localized area of the DML. They suggest that a geochemical barrier exists in groundwater systems that may preclude migration of agricultural contaminants into underlying bedrock aquifers.

9.6            1.2            Turn right on County Rd. E41. Proceed north.

10.8           1.2            Cross railroad tracks and continue north (becomes US Hwy. 17).

12.7           1.9            Turn right on County Rd. E26 and proceed east.

14.7           2.0            Turn left.

**Stop 1. Thompson Farm.**

16.7           2.0            Leave Thompson Farm. Turn left on County Rd. E26 and proceed west to stop sign. Turn right on State Hwy. 17 and proceed north.

19.1           2.4            Cross Onion Creek.

- 20.1 1.0 Cross Montgomery Creek. Ascend Altamont ice margin, a hummocky ridge system (category HRS). Note microwave tower to the right on the crest of the moraine. This part of the Altamont Moraine is known locally as Mineral Ridge. The road cut along Hwy. 17 near the moraine crest exposed more than six meters of resedimented diamicton and sorted sediments (Dows Fm., Morgan Mbr).
- 22.4 2.5 Pass junction with County Rd. E18. As we continue north beyond the crest of the moraine note that the hummocky topography marking the position of the “end moraine” actually sits lower in elevation than the moraine crest, and that there is a broad sag behind the moraine. The linked-depression system that defines the area of hummocky topography drains toward the sag behind the moraine.
- 24.5 1.9 Cross south branch of Squaw Creek.
- 25.5 1.0 Enter Hamilton Co. To the left is a kame (tree-covered ridge). This kame is composed of sand and gravel (Pilot Knob Mbr. of Dows Fm.).
- 26.6 1.1 Cross north branch of Squaw Creek.
- 27.0 0.4 To the left is another tree-covered kame and to the right is an esker-type feature, both composed of Pilot Knob Mbr. deposits.
- 30.6 3.6 Ascending onto ramp of Altamont ice margin complex a hummocky plateau (category HP). The accordant level of the hummock tops in this area define a plateau. Enter Stanhope.
- From Stanhope to about Fort Dodge we will travel through a low to moderate relief plain with irregular surface patterns (category PU). This landscape was previously referred to as “ground moraine.” Several cores taken from the area between Webster City and Stanhope show that the typical sedimentary sequence in this landform area is one to two meters of fine-grained glacial lake sediments (Lake Mills Mbr.) overlying massive, dense Alden Mbr. diamicton. Often a thin layer of sand and gravel is found at the base of the Lake Mills Mbr.; probably representing wedges of sorted sediment from adjacent ice-cored slopes, and deposits generated by wave action.
- 33.5 2.9 Many hog confinement facilities to the right, left, and ahead. Hamilton County has 20% of the permitted EMS on the DML, and 10% of the permitted EMS sites statewide. Permitted EMS sites in Hamilton County house approximately 313,000 head of hogs. To the left-Boone River valley in the distance.
- 40.6 7.1 Cross the Boone River. Note deeply entrenched valley, and numerous benched, unpaired terraces. The Boone River heads along the Algona ice margin, and was a major meltwater channel when the Des Moines Lobe glacier was at that position (c.a. 12,200 B.P.). The fill of the benched terraces along this valley consist of sand and gravel of the Noah Creek Fm. These deposits exhibit stratigraphy and sedimentology similar to correlative deposits studied nearby in the

		Des Moines River valley.
42.0	1.4	Drive over US Hwy. 20 and turn left onto Hwy. 20 approach ramp. Proceed west on US Hwy. 20. Continue west across low relief plain with irregular surface patterns.
47.6	5.6	Borrow pit on left side of road—note high water table (within <5ft. of land surface). High water tables are common over large parts of the Des Moines Lobe.
50.5	2.9	On right note another borrow pit.
51.7	1.2	Note sign to Brushy Creek State Recreation Area (to left). Some aspects of stratigraphic studies in the Brushy Creek area will be discussed at Stop 2.
56.1	4.4	On the right outcrop of Pennsylvanian siltstones, mudstones, and coal along an unnamed tributary of the Des Moines River valley. This outcrop includes rocks of the Kalo Fm. of the Cherokee Group. Coals beds in the area are most likely the Cliffland Coals.
57.0	0.9	Turn right at Coalville Exit 124.
57.3	0.3	Stop sign. Turn right onto County Rd. P59 and proceed north.

The Fort Dodge area is one of the leading gypsum producing areas in the United States. About 1.5 million metric tons of gypsum (with a raw value of \$10 million) was mined and processed in the area in 1994 by four companies: United States Gypsum Corporation, National Gypsum Company, Georgia-Pacific Corporation, and the Celotex Corporation. This production accounts for about 75% of the total gypsum mined in Iowa, making Iowa second only to Oklahoma among the states in annual gypsum production. Most (over 70%) of the gypsum mined in the United States (and in the Fort Dodge area) today is used to produce plaster of Paris, primarily for used in wallboard (drywall). Most of the rest of the gypsum (18%) is used as a retarder to slow the setting of portland cement. Gypsum is also used as plaster, soil conditioner, inert filler in pharmaceuticals and foods, and a small amount is carved into ornaments and sculptures (including the Cardiff Giant, which was constructed from gypsum quarried from exposures about 4 miles south of the Kauffman-George Quarry--Stop 2).

#### **History of Gypsum Production in Fort Dodge**

The history of gypsum production in the Fort Dodge area was most recently summarized by McKay (1985). He reported that gypsum had been utilized by people in the Fort Dodge area since the 1850s. The gypsum occurrence was first reported in the geologic literature by geologist David Dale Owen (1852) who noted exposures along the Des Moines River. Keys (1893) described the gypsum beds at Fort Dodge as "by far the most important bed of plaster-stone known west of the Appalachian chain, if not in the United States." At first Fort Dodge residents used gypsum only for building stones which they "preferred to the limestone of good quality" that also existed in the

area (White, 1870). The building stone was quarried from the first known gypsum quarry in the area, the Cummins Quarry.

In 1872 Captain George Ringland, Web Vincent, and Stillman T. Meservey built the first mill in the area, the Fort Dodge Plaster Mill, to grind gypsum for commercial products. The success of this mill led to the construction of others, and by 1902, 7 mills were operating in the area producing a variety of products including building blocks, mortar, plaster, roofing, and flooring products.

The original quarrying operations soon gave way to underground mining. Although most of the underground mine areas have been subsequently stripped and the remainder of the gypsum removed, some areas south of Fort Dodge are still undermined. Collapse in these mined areas, with only a thin layer of gypsum left beneath the Quaternary section, is not uncommon. In some places the landscape takes on the appearance of a karst terrain. Today all mining is done by open pit operations, using a variety of equipment to strip off the Quaternary deposits, blasting the gypsum, and hauling it to the mills.

The four gypsum-producing companies that currently operate in the Fort Dodge area run their mills 24 hours a day and most of the quarries run two shifts seven days a week. The gypsum resource at Fort Dodge is extremely limited, existing as a small outlier of about 20 km<sup>2</sup>, and completely isolated from other Late Jurassic deposits by several hundred kilometers. Gypsum reserves are sufficient for about 30 years at the current rate of extraction for some of the companies; others have only minimal reserves that will be depleted in a few years.

### **Stratigraphy**

The gypsum beds in the Fort Dodge area are a part of a unit called the Fort Dodge Formation. The formation consists of a basal, very dark gray plastic shale, which is overlain, apparently conformably, by a very pure gypsum bed, which is, in turn, overlain by a series of red mudstones and sandstones collectively referred to as the “Soldier Creek beds.” The contact between the gypsum and the “Soldier Creek beds” is unconformable, with up to 3 m of relief on the gypsum surface. Where the “Soldier Creek beds” are present and thick, the erosional relief is minimized. The deeply eroded gypsum is overlain by Pre-Illinoian glacial diamicton. In the southwest portions of the unit’s outcrop belt, the basal shale is underlain by a thin sequence of sandstones and conglomerates. The basal shale ranges in thickness from a few cms in the southwest to in excess of 3 m in the northeast (Kauffman-George Quarry--Stop 2). A representative section is shown in Figure 1.

### **Age**

The age of the Fort Dodge Formation has not been conclusively determined, however a palynologic investigation of the gypsum bed by Cross (1966) stated that the unit was probably Upper Jurassic

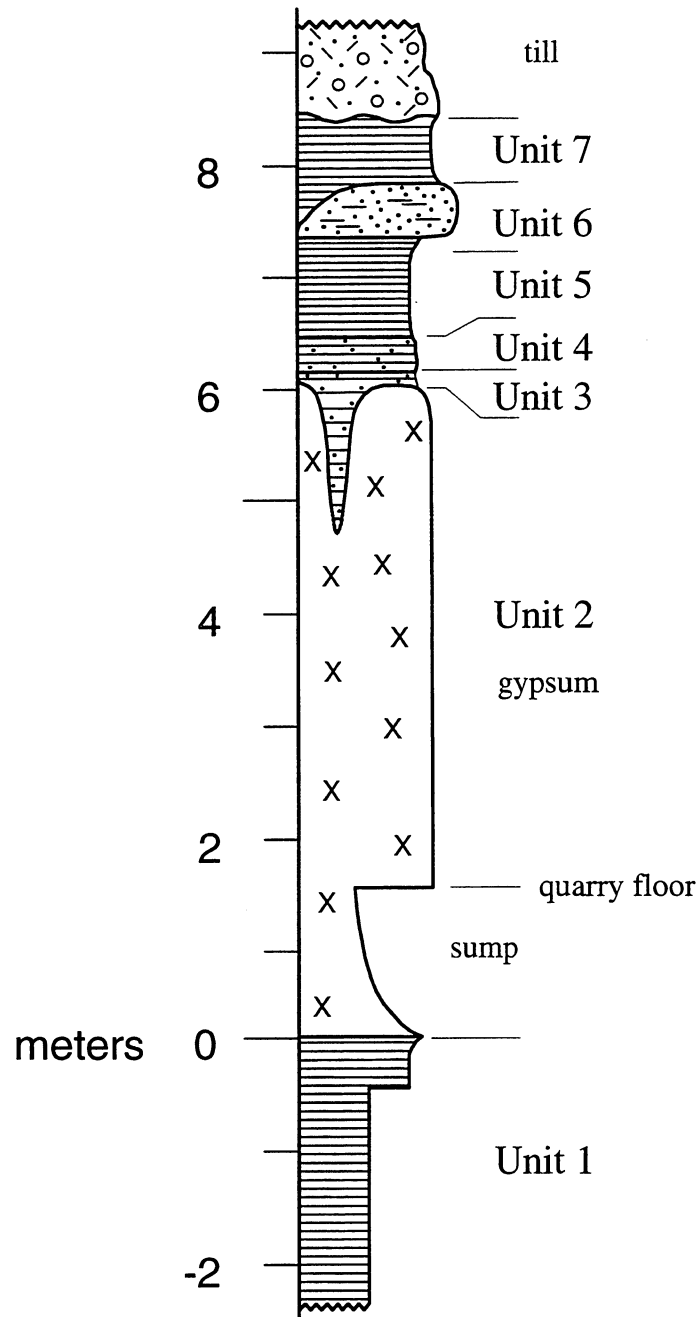


Figure 1. Representative section of the Fort Dodge Formation.

Kimmeridgian or lowermost Cretaceous. Interpretation of paleogeographic reconstructions by Scotese (1991) indicates that North America was moving northward from the Middle Jurassic through the Lower Cretaceous, and that the Fort Dodge area was at dry, evaporite latitudes (~10-30°) during the Upper Jurassic (Ludvigson, 1996). This suggests that the Fort Dodge gypsum was deposited in the Upper Jurassic, probably at a time of near maximum marine transgression, equivalent to the Sundance Formation (possibly basal Morrison Formation) of the Rocky Mountain states.

57.8	0.5	Note large spoil piles from nearby gypsum mining operations.
58.8	1.0	To the left are the United States Gypsum (USG) pits.
59.2	0.4	Celotex gypsum pits on left.
60.7	1.5	Stop sign. Turn right on County Rd. D20. Proceed east.
62.6	1.9	Turn left on County Rd. P63. Proceed north.
63.5	0.9	Stop sign on P63. Junction with County Rd. D18 continue north on P63.
64.5	1.0	Turn right on 180 <sup>th</sup> St. Proceed east.
65.0	0.5	<b>Stop 2. National Gypsum Company's Kauffman-George Pit.</b>
65.4	0.4	Leave quarry go west on 180 <sup>th</sup> St. Stop sign. Turn right on County Rd. P63. Proceed north.
66.4	1.0	Stop sign. Turn left on County Rd. D14. Proceed west.
69.3	2.9	Stop sign. Cross County Rd. P59 and continue to proceed west on D14.
70.7	1.4	Note that topography becomes progressively more dissected as we approach the Des Moines River valley (DMR).
71.2	0.5	Enter DMR. The DMR heads on the part of the Lobe covered by the Algona ice advance. The valley originated as the axial subglacial drain of the Des Moines Lobe glacier and developed into a major subareal drainage line when the Des Moines Lobe glacier was at the position of the Algona ice margin. The valley incision we see developed when the glacier was at the Algona ice margin between about 12,600 and 12,000 B.P. As we proceed across the eastern side of the valley we are driving across a Late Wisconsinan (LW) benched terrace. Note the small gravel pit on the left and the pile of boulders found as a lag on the till surface beneath about ten feet of outwash (Noah Creek Fm.).
71.8	1.6	Cross the Des Moines River. Boulders in the bed of the river in this area indicate that till and/or bedrock are near the bed of the stream.
72.4	0.6	Note gravel pit developed in benched terrace on left.
72.6	0.2	Drive across LW benched terrace.
73.2	0.6	Stop sign. Turn right and proceed north on US Hwy. 169. Note gravel pits to right.
74.4	1.2	Continue north and ascend slope of the Clare ice margin, one of the "minor" positions of the Des Moines Lobe glacier between the

		Altamont and Algona advances. To the right note high LW benched terraces of the DMR inset below the Clare margin. The DMR truncates the Clare, and is therefore younger than the moraine. The stratigraphy and sedimentology of the Lobe's outwash deposits (Noah Creek Fm.) will be discussed in detail at today's last stop in Milford.
74.9	0.5	On crest of the Clare ice margin. Enter hummocky plateau landform area (category HP) as we descend the crest.
76.6	1.7	Continue north and drop back into the DMR. Note numerous benched terraces.
77.5	0.9	Leave the DMR.
77.8	0.3	To the left is the Farm Egg Plant. Excavation for the waste water lagoon exposed 4.1 m (13.5 ft) of faulted and deformed, ice-contact sand and gravel (Pilot Knob Mbr. of Dows Fm.) that abruptly overlay 5.5 m (18 ft.) of Morgan Mbr. stratified diamicton and sorted sediments. The Dows Fm. deposits unconformably overlay oxidized and jointed Pre-Illinoian diamicton of the Wolf Creek Fm's. Hickory Hills Mbr. Note benched terrace of DMR to the right.
80.0	2.2	Humboldt County line.
82.0	2.0	Cross Indian Creek. Note benched terraces on left, and that Indian Creek sits in a sag on the upland surface.
83.6	1.6	To the right note the deeply entrenched DMR.
84.5	0.9	Enter Humboldt.
85.2	0.7	Cross West Fork DMR.
85.8	0.6	Stop sign. Turn left and proceed west on State Hwy. 3.
87.3	1.5	Cross West Fork DMR. The upland from here to our next stop along the upper reaches of Indian Creek is a plain with irregular surface patterns, but with a very low-relief, reticulate linked depression system on the plain surface (category PD1). All the surface drainages in this area are joined by the linked-depression system.
89.3	2.0	To the right note cement curbing in field. This is an agricultural drainage well (ADW). An ADW is a drilled shaft that serves as an outlet for drainage tiles to funnel excess drainage water to bedrock aquifers. ADWs are one of the Lobe's environmental issues and will be the topic of Stop 9 tomorrow. The presence of ADWs is an indication that bedrock is near the land surface. 2.5 km to the north in Weaver Construction's Rutland quarry, 8.2 m (27 ft.) of Alden Mbr. diamicton buries Glimore City Limestone (Mississippian). On the southeast intersection of the road going to Rutland there is a ridge composed of Pilot Knob Mbr. A small pit dug into the ridge exposed more than 3 m of sand and gravel with a few interbedded diamicton beds. The deposits also exhibited excellent collapse deformation structures typical of Pilot Knob Mbr. deposits.
93.9	4.6	To right note another ADW in field.
94.6	0.7	Turn left onto Colorado Ave. Proceed south.
95.5	0.9	Turn right on 230 <sup>th</sup> St. Proceed west.

96.5	1.0	Turn left on Birch Ave. Proceed south past Davis Farm on left (east).
96.7	0.2	<b>Stop 3. Davis Farm—Indian Creek Transect.</b> Depart bus and proceed left (east) to field entrance.
		Leave Stop 3. Proceed north on Birch Ave.
98.0	1.3	Stop sign. Turn left onto State Hwy. 3 and proceed west.
98.6	0.6	Enter Gilmore City.
98.0	0.4	Turn right on County Rd. P19. Proceed north.
99.5	0.5	To the left is Hallett’s Gilmore City Quarry. Quaternary deposits in the Gilmore City area are thin, with maximum thickness of only 3.9 m (12.8 ft.) at the Hallett Quarry. All Quaternary deposits exposed in the quarry are part of the Dows Fm.; 1.6 m (5.3 ft) of massive, firm Alden Mbr. diamicton overlain by 2.3 m (7.5 ft) of Morgan Mbr. which consists of diamicton and interbedded thin, discontinuous, deformed beds of sand and silt. The Dows Fm. overlies a fractured, rubbly bedrock surface with only a very few restricted areas where the bedrock surface is a striated pavement.
103.7	4.2	Entering West Fork DMR. Note that the valley is relatively wide and shallow. Lateral migration of the river during the Holocene has removed most LW outwash terraces in this area. The floodplain is underlain by fine-grained DeForest Fm. deposits that grade downward to coarser channel deposits.
104.0	0.3	Cross West Fork Des Moines River.
104.5	0.5	Enter Bradgate. Turn left and follow County Rd. P19.
105.0	0.5	Ascend Renwick Moraine.
111.0	6.0	Stop sign. Intersection with State Hwy. 15. Continue straight north on Hwy. 15.
111.9	0.9	Up ahead note the West Bend ice margin.
112.7	0.8	Ascending front slope of the West Bend ice margin, a non-hummocky ridge system (category NRS) in this area.
114.1	1.4	Enter West Bend. Proceed north.
115.1	1.0	Turn left on 4 <sup>th</sup> St. Proceed west.
115.2	0.1	Turn left on Broadway Ave.
115.3	0.1	<b>Lunch Stop. Grotto of the Redemption.</b>
		The Grotto of the Redemption was designed and constructed by Rev. Father P.M. Dobberstein beginning in 1912. Legend has it that as a young seminarian Father Dobberstein became critically ill with pneumonia and prayed to the Blessed Virgin to intercede for him. He promised to build a shrine in her honor if he lived. The Grotto of the Redemption was designed to tell the story of man’s fall and his redemption by Christ. This is accomplished through nine grottos, or scenes from the life of Christ, each of them portraying a portion of the story of the redemption.



All work on the first 80% of the project was by hand. The number, weight, and types of stone used to construct the grotto are unknown. The white marble of the statuary groups was mined in the Appenines of Italy. The grotto even contains a rock specimen collected during the Byrd expedition to the Antarctic.

- |       |     |   |
|-------|-----|---|
| 115.4 | 0.1 | Leave Grotto. Turn left on 2 <sup>nd</sup> St. Proceed east.  |
| 115.5 | 0.1 | Stop sign. Turn left on State Hwy. 15. Proceed north. Note Prairie Creek valley to the left. Prairie Creek is a drainageway that carried valley-train outwash from the Algona ice margin.   |
| 122.5 | 7.0 | To the right is the town of Whittemore. Straight ahead is the front of the Algona ice margin. The DML glacier stood at this position about 12,000 B.P. Note EMS site at base of the moraine.<br><p>The 55 Whittemore SE site is located in an abandoned proglacial outwash channel along the southern limit of the Algona advance about 2 km southeast of Whittemore. This abandoned channel formerly connected Lott's Creek down valley to Hine Creek. A sand-and-gravel operation exposes 6.4 m (21 ft.) of Noah Creek Fm. deposits at this site.</p> <p>The stratigraphic sequence consists of a thin veneer of fine-grained sediments overlying cosets of large-scale trough and planar cross-bedded pebbly sands and sands (Kemmis, 1991). Interbedded with the cross-bed cosets in isolated areas were lenticular masses of very fine sand interpreted as bars. Pieces of wood (shredded spruce tree trunks and branches) were associated with these sand bars. Radiocarbon dates on spruce logs collected on two occasions help determine the age of the Algona advance; 12,020±170 B.P. (I-8768) and 12,000±105 B.P. (DIC-1362).</p> <p>The stratigraphic sequence is interpreted to have been deposited in a wide, low-sinuosity channel in which dunes of pebbly sand migrated repeatedly during relatively steady, low-flow regime conditions. Infrequently, as stage fell, bars of massive fine sand were deposited and drift wood stranded. The thin increment of fine-grained sediment at the top of the sequence probably formed as flow waned when the channel was abandoned.</p> |
| 128.1 | 5.6 | Stop sign. Turn left on US Hwy. 18. Proceed west.<br>Crossing the Cylinder outwash fan. This outwash fan is associated with the southern margin of the Algona advance. Noah Creek Fm. deposits underlie the land surface here. Note irrigation rigs drawing water from saturated sections of the Noah Creek Fm. to the left, and EMS sites to the north.  |
| 128.7 | 0.6 | Enter Cylinder.   |
| 129.7 | 1.0 | To the right note EMS sites and irrigation rigs on outwash fan.   |
| 130.5 | 0.8 | Go straight rather than follow US Hwy. 18. Stop sign. Turn right on County Rd. N60. Sand and gravel pit exposing Noah Creek Fm. deposits to the left. Note the relatively high water table. This outwash  |

		is associated with Cylinder Creek which drained the Algona ice margin. EMS sites ahead on outwash near gravel pit.
131.1	0.6	Stop sign. Turn left on County Rd. N60 and proceed north. Note more gravel pits to the left and right all developed in Noah Creek Fm. deposits. Algona ice margin ahead. In this area the Algona margin is a non-hummocky escarpment (category NE).
139.7	8.8	Stop sign. Turn left on County Rd. B14 and proceed west. Behind the Algona margin are several types of plains (category P) landforms.
145.8	6.1	Jack Creek to the right.
146.5	0.7	Cross deeply incised valley occupied by Jack Creek. Jack Creek is the major outlet channel for a series of large linked depressions—High, Ingham, and Swan Lakes. This outlet drains into the West Fork DMR just south of Graettinger.
147.4	0.9	Turn right on County Rd. N40. Proceed north. To the left is the Altamont ice margin.
151.1	3.7	Note High Lake on left and Ingham Lake on right. Lake bed surveys done in the 1930's recorded water depths of four to six feet in these lakes. High Lake drains to Ingham Lake (formerly known as Mud Lake), which drains northward to Swan Lake, then into Jack Creek, which is a tributary of the West Fork DMR. These lakes sit in a hummocky plateau (category HP) area.
153.1	2.0	Turn left on County Rd. A34. Proceed south around curve and then head west.
154.8	1.7	Note Altamont ice margin ahead. West Fork DMR in the foreground.
156.4	1.4	Turn left on County Rd. A34 and proceed west into the West Fork DMR. The east valley wall of the West Fork marks the Algona ice margin in this area. The West Fork heads in areas of linked-depression systems in southern Minnesota.
156.5	0.1	Cross West Fork DMR. Crossing Holocene floodplain underlain by DeForest Fm. deposits. Enter Wallingford.
157.5	1.0	Stop sign. Turn left on State Hwy. 4. Proceed south. The 32 Wallingford SE and 32 Osher-1 sections were described in gravel pits in a terrace inset against the Algona margin (Kemmis, 1991). These pits expose Noah Creek Fm. sediments that were deposited during the Algona glacial advance. Kettle depressions between the terrace and upland formed as the stream flowed against glacial ice of the Algona margin. The sedimentary assemblage at these sites is complex and represents deposition of coarse glaciofluvial deposits during periods of fluctuating water and sediment discharge.
157.6	0.1	State Hwy. 4 bears left. Go straight on County Rd. A34. Continue south and then curve west.
158.0	0.4	Ascend Altamont ice margin, a hummocky plateau (category HP) in this area.
160.8	2.8	Turn right on County Rd. N26 (flashing yellow light). Proceed north through hummocky plateau area.
162.7	1.9	Note “doughnut” features on left. Turn left on gravel.

163.0	0.3	<p>Proceed west. To the left is a large “hummock” or “doughnut,” the site of the 32 Raleigh Site. This hummock has an elevated rim around its outer edge. This surface morphology is similar to “ice-contact rings” (Parizek, 1969) and “doughnuts” (Clayton, 1967), landforms interpreted to have formed when material deposited in supraglacial lakes becomes topographically inverted (forming a hummock) when the surrounding glacial ice melts away. Relief around the hummock varies with the depth of surrounding interconnected drainageways and linked-depression systems.</p> <p>Transects of cores were drilled across this hummock in order to determine the stratigraphic relationships of the deposits comprising the landform. Complex stratigraphic sequences in the cores were grouped into lithofacies assemblages that were used to infer the origin of the stratigraphic sequence comprising the landform. Fine-grained Lake Mills Mbr. deposits overlay thinner, sand and gravel deposits of the Lake Mills Mbr. in the hummock’s central depression. The hummock rim consists of stratified diamicton and sorted sediments of the Morgan Mbr. deposits also underlie Lake Mills Mbr. deposits in the central depression area. The core of the hummock consists of dense diamicton (melt-out till) of the Alden Mbr.</p>
164.6	1.6	<p>Stop sign at T intersection. We are on the western Altamont ice margin which is a high relief, north-south trending, non-hummocky ridge system (category NRS) in this area. To the west is a plain underlain by diamicton deposited during the Bemis ice advance. Turn right on County Rd. N24.</p>
165.6	1.0	<p>Turn left at T intersection. Proceed west on county A31 and drop off the Altamont glacial margin onto a plain underlain by diamicton deposited during the Bemis glacial advance.</p>
169.4	3.8	<p>Stop sign. Cross County Rd. N14. Proceed west.</p>
174.3	4.9	<p>T intersection. We are now on the Altamont-Bemis glacial margin complex in an area of hummocky topography (category HRS--hummocky ridge system). Many lakes, including the Iowa Great Lakes, are present in this part of the Altamont-Bemis Complex. Turn left on County Rd. M56. Go south and drop off the Altamont-Bemis Complex onto a plain covered by the Bemis glacial advance. The landscape drops off to the southwest and we can see the western terminal margin of the Lobe from here.</p>
176.2	1.9	<p>Turn right on County Rd. A34. Proceed west back onto the Altamont-Bemis Complex.</p>
179.0	2.8	<p>Okoboji Outlet Channel on right and Berning Fen. Sand and gravel pits to the left are in Noah Creek Fm. glaciofluvial deposits associated with the Okoboji Outlet Channel.</p>
179.8	0.8	<p>Turn right into parking lot. <b>Stop 4. Kruse-Milford Pit.</b></p>
180.0	0.2	<p>Stop light. Intersection with US Hwy. 71. Turn right. Proceed north. Most of the City of Milford sits on Noah Creek Fm. deposits that are part of an outwash plain/fan complex associated with the Okoboji</p>

		Lake Outlet and the Little Sioux River Valley. These outwash deposits are at and beyond the margin of the DML
181.9	1.9	Turn left. Proceed west and north on State Hwy. 86. We are once again driving on part of the Altamont-Bemis Complex.
185.9	4.0	Turn right. <b>Lakeside Laboratory along the shore of Miller's Bay, West Okoboji Lake.</b> Lodging and dinner. Part of the group will be lodging next door at the Presbyterian Camp. Lodging instructions will be given on the bus. <b>Dinner at the Lakeside Laboratory Dining Hall at 6:30 p.m.</b>

**End of Day**  
**1**

Little Millers Bay, a northwestward extension of Miller's Bay, is the location of the Little Miller's Bay Core, the Type Site for the West Okoboji Member of the DeForest Fm. Pollen and plant macrofossils recovered from the core provide a detailed record of Holocene vegetation changes during the last 14,000 years (Van Zant, 1979).

West Okoboji Lake is Iowa's deepest natural lake. Its maximum depth of 134 feet (40.8 m) is attained between Gull Point, south of Miller's Bay, and Smith's Bay on the east side of the lake.

## Day 2 Log

Acc. Mileage (miles)	Distance (miles)	Notes
0	0	Sunday morning. <b>Breakfast 6:30-7:15 a.m. at Lakeside Laboratory Dining Hall.</b> Board bus by 7:45 a.m. Depart Lakeside Laboratory. Turn right and proceed north on State Hwy. 86.
3.5	3.5	Turn left. Proceed west on State Hwy. 9.
5.7	0.8	Ascend back side of the Bemis-Altamont ice margin complex.
6.5	0.8	In front of us is the Little Sioux River valley. The Little Sioux Valley was proglacial to the Altamont ice margin in this area.
7.0	0.5	Cross Little Sioux River valley.
9.1	2.1	Cross West Fork of Little Sioux Valley.
11.0	1.9	Turn left on 140 <sup>th</sup> St. Proceed south.
14.0	3.0	Site of Dugout Creek Wetland Restoration Project.
14.4	0.4	<b>Stop 5. Excelsior Fen Complex.</b> Leave Stop 5 and proceed north on 140 <sup>th</sup> St.
15.0	0.6	Stop sign. Turn right on State Hwy. 9. Proceed east.
21.2	6.2	Stop sign. Turn left on State Hwy. 86. Proceed north.
23.1	1.9	Turn right onto 130 <sup>th</sup> St. Proceed east on gravel.
23.4	0.3	Welsh Lake State Wildlife Management Area on left.
24.1	0.7	Turn left on 215 <sup>th</sup> Ave. and proceed north. Note linked-depression system on the left.
24.6	0.5	Turn right on 125 <sup>th</sup> St. and proceed east
25.1	0.5	On the right note kame composed of Pilot Knob Mbr. (Dows Fm.). The ridge to the left is a possible esker (also composed of Pilot Knob Mbr. deposits) in the Kettleston Hogsback State Wildlife Management Area.
26.4	1.3	Stop sign at T intersection. Turn left on State Hwy. 276. Big Spirit Lake, the largest natural lake in Iowa, is on the right. Water depth averages about 21 feet (6.4 m) across the lake.
28.9	2.5	Turn right on Mini-Wakan State Park Thruway. Minnesota on left, Iowa on right. Big Spirit Lake on right.
33.8	4.9	Turn left on County Rd. A15. Proceed east.
37.1	3.3	Stop sign. Cross US Hwy. 71. Proceed east on 120 <sup>th</sup> St., gravel road. We are crossing a broad belt of hummocky topography (category HRS, hummocky ridge system) associated with the Algona-Altamont Complex.
38.8	1.7	Stop sign. Cross County Rd. N16. Proceed east.
39.7	0.9	Cross Christopherson Slough, part of the Swan Lake and Christopherson Slough State Wildlife Management Area.
39.9	0.2	Turn right on 330 <sup>th</sup> Ave.
40.0	0.1	<b>Stop 6. Morgan Mbr. Outcrop and Coffee Break.</b>
40.8	0.8	Turn left on 130 <sup>th</sup> St. Note more exposures of Morgan Mbr. on right.
41.8	1.0	Stop sign. Cross County Rd. N22. Proceed east on County Rd. A17. Cross Emmet Co. line. We are in a belt of high relief hummocky

43.4	1.6	topography (category HRS) associated with the Altamont ice margin. Drop into West Fork Des Moines River valley. Note gravel pits developed in Noah Creek Fm. deposits and benched terraces in the entrenched valley. In Emmet Co. the West Fork DMR runs south along the Algona ice margin and just behind the Altamont ice margin.
44.1	0.7	Cross West Fork DMR. Ascend valley wall onto the Algona ice margin. In this area the landscape is a plain with lineated depressions (minor moraines) inset on an irregularly patterned upland (category PL).
45.2	1.1	Stop sign. Cross County Rd. N26 (flashing red light). Continue east on A17. The landscape changes from a plain with lineated features (category PL) to a plain with various types of discontinuous ridges and hummocks (categories PU, PR, and PH).
46.5	1.3	Stop sign. Cross State Hwy. 4. Continue east on A17.
51.5	5.0	On left note “doughnut” features. Subsurface investigations south of here in a similar landscape setting along the 32 Estherville Transect (Kemmis, 1991) showed that hummocks in this area have stratigraphic relationships similar to those found at the 32 Raleigh Transect, but in central Emmet County the hummocks appear to stand above the adjacent landscape and linked-depression systems are not present.
55.3	3.8	Cross Soldier Creek. Note gravel pits developed in Noah Creek Fm. deposits. Soldier Creek was a major outwash channel draining this part of the Lobe.
56.2	0.9	Stop sign. Turn left on County Rd. A17 and County Rd. N52 and proceed north.
56.6	0.4	Turn right on County Rd. A17 and proceed east. Enter Dolliver and follow A17.
57.6	1.0	Stop sign. Turn right on 120 <sup>th</sup> St. Pass Tuttle (or Okamanpedan) Lake, the source of the East Fork DMR.
59.2	1.6	Cross East Fork DMR. Gravel pit developed in Noah Creek Fm. deposits on right.
64.3	5.1	Iowa Lake to the left. This lake and the drainage system in northern Kossuth County drains north to the Blue Earth River system, which is a tributary to the Minnesota River.
65.3	1.0	Stop sign. Turn left on State Hwy. 15 and proceed north.
66.3	1.0	Turn right and proceed east on County Rd. A16 through a hummocky plateau area with well-defined linked-depression systems (category HP). Note “doughnut” on right.
68.1	1.8	Goose Lake, on the right, also drains north to the Blue Earth River system. Going east we leave the hummocky plateau and enter a plain with lineated features transverse to the glacier-flow direction (category PL).
73.4	5.3	Stop sign. Cross County Rd. P30. Continue east on A16. We now are driving across a plain with irregular surface patterns, but with some areas of rounded, irregularly shaped patterns (category PS).
80.1	6.7	Turn right. Proceed south on County Rd. P50. Within two miles we pass into a plain with lineated surface patterns transverse to the

		glacier-flow direction (category PL).
81.2	1.1	Note ridge on right with radio tower on its crest. Several northwest-southeast trending ridges, including some small areas of hummocky topography, are present in the northern part of Kossuth County and southern Martin and Fairbault counties in Minnesota. Drainages head along these ridges and Noah Creek Fm. deposits are often present. These may represent ice marginal positions behind the Algona ice margin akin to the Clare, Renwick, and West Bend ice margins behind the Altamont.
81.8	0.6	Cross West Branch Blue Earth River (ditch), which flows northward and is a tributary of the Minnesota River.
84.7	2.9	Continue straight ahead on gravel road as P50 curves to left.
85.5	0.8	Stop sign. Turn right onto County Rd. P50. Note chemical and fertilizer dealership on right. Agricultural contaminants present both point and nonpoint source pollution hazards in Iowa.
87.0	1.5	Stop sign. Turn right on State Hwy. 9 and proceed west.
89.3	2.3	Turn left. Proceed south on US Hwy. 169.
95.1	5.8	Enter Bancroft.
97.2	2.1	Turn left on County Rd. A42 and proceed east.
102.6	5.4	<b>Stop 7. Union Slough National Wildlife Area.</b>
105.9	3.3	Turn right. Proceed south on County Rd. P64. We are now crossing a plain with generally irregular surface patterns, but with limited areas of rounded, irregularly shaped patterns (category PS).
108.7	2.8	Stop sign. Turn left on County Rd. B14 and proceed east through Titonka ("Buffalo" in Lakota Sioux). Cross Buffalo Creek which connects the East Fork DMR with various linked-depression systems along the lateral margins of the Algona ice advance in northwestern Hancock Co.
115.4	6.7	Stop sign. Turn right and proceed south on County Rd. R20.
115.9	0.5	Enter Woden.
116.2	0.3	Follow left road on County Rd. B35 (to Crystal Lake). We are now approaching a non-hummocky ridge system (category NRS) along the backside of the Algona ice advance margin.
118.5	2.3	Woden Bog on right. This is the location of the 41 Woden Bog core, the Type Site of the Woden Mbr. of the DeForest Fm. This was one of the four large semi-closed depressions on the DML studied by Walker (1966) He found a similar stratigraphic sequence in each depression. The sediment sequence is composed of alternating zones of organic deposits (muck) and fine-grained slope-derived deposits. Walker correlated the successions, subdividing each into four informal zones : Upper Muck, Upper Silt, Lower Muck, and Lower Silt. Inferred ages on the zones from radiocarbon ages at McCulloch Bog (associated with the Altamont ice margin complex in southern Hancock County) were about 11,700 B.P. for the Lower Silt, 8,100 B.P. for the Lower Muck, and 6,500 B.P. for the Upper Silt. The zones were related to changing climate and vegetation during the Holocene. The silt zones

were deposited as colluvium and sheet wash during periods of hillslope instability, and the muck zones formed during periods of hillslope stability when the rate of organic matter accumulation exceeded the rate of mineral sediment deposition in the basins.

Woden Bog is part of a large linked-depression system that drains the Algona ice margin. Although large semi-closed depressions like this one appear as single, relatively large depressions on the present surface, subsurface studies indicate that they consist of several, small, coalesced basins in the subsurface (Walker, 1966). At Woden Bog the maximum thickness of the Woden Mbr. is 9.9 meters (32.5 ft), and it buries Dows Fm. diamicton.

- |       |     |  |
|-------|-----|--|
| 119.2 | 0.7 | Turn right on Grant Ave. and proceed south.  |
| 120.2 | 2.0 | Proceeding south we traverse a tunnel valley that drains to an outwash plain in front of the Algona ice margin. On the right note the esker running down the center of the tunnel valley. The upland to the east is a hummocky ridge system (category HRS) area of the Algona ice margin.  |
| 122.1 | 1.9 | Stop sign. Turn left and proceed east on County Rd. B20. Going east we drop off the Algona ice margin, which is a non-hummocky escarpment here (category NE), and onto the Britt outwash plain, one of the largest in Iowa.  |
| 122.4 | 0.3 | To the right the lower reach of the tunnel valley we just crossed feeds out of the Algona ice margin onto the outwash plain. When Ditch No. 1 was expanded a few miles south of here (see location of Britt forest bed in Ruhe, 1969, p. 64), a spruce forest rooted in Dows Fm. diamicton and buried by Noah Creek Fm. glacial outwash was exposed. Radiocarbon ages on wood (12,790±250, W-626) and peat (13,030±250, W-625) provide ages consistent with others associated with the Algona ice advance. Landscape relationships suggest that the outwash that buried the Britt forest bed probably exited the glacier via the tunnel valley we drove through.           |
|       |     | The 41 Crystal Lake SE section is located about one mile to the north in the terminal ridge of the Algona ice margin (Kemmis, 1991). A small gravel pit along a north-south trending hummocky ridge within a hummocky escarpment area (category HE) exposed a complex sequence of Pilot Knob Mbr. deposits. The stratigraphic sequence was interpreted to have been deposited in an ice-walled and ice-floored channel system (Kemmis, 1991). Tilting and faulting of the sequence resulted from the melting and collapse of the adjacent ice walls and floor. The observed sequence was similar to ice-contact deposits forming in present-day ice-marginal environments. |
| 123.2 | 0.8 | Cross West Branch of the Iowa River (ditch). Note front of the Algona ice margin (behind church). Also note irrigation rigs on outwash plain.  |
| 125.0 | 1.8 | Stop sign. Turn left onto County Rd. R35 and proceed north.  |
| 125.4 | 0.4 | Ascend Algona ice margin, a hummocky ridge system (category HRS) in this area. Note hummocky topography in sag behind the moraine  |



		crest.
126.9	1.5	Turn right and proceed east on County Rd. B16. Cross from a hummocky plateau (category HP) to a hummocky ridge system (category HRS) along the Algona ice margin.
129.3	2.4	Drop off Algona ice margin into West Branch Iowa River valley.
129.9	0.6	Drive across high terrace of the West Branch Iowa River.
		<p>The 41-Kirshbaum-1 section is located in an abandoned proximal channel that is ice marginal to the Algona, (Quade,1992) (see Stop 8, Figure 1, p.142). A small sand and gravel operation exposed 4.0 m (13 ft.) of Noah Creek Fm. deposits at this site. The stratigraphic sequence consists of a thin veneer of fine-grained sediments overlying a massive pebble gravel that is truncated in places by small-scale simple channel fills. Cluster bedforms (Brayshaw, 1984) were also observed in the pebble gravel. The increment of small-scale channel fills overlies the lowermost increment consisting of complex crossbeds. This stratigraphic sequence is interpreted as forming under fluctuating flow conditions. Sedimentary structures of the lowermost increments suggest lower-flow regime conditions. The massive pebble gravel overlying the complex crossbeds is interpreted to have formed during a large-scale flood event. The cluster bedforms, closely nested groups of clasts deposited in trains parallel to flow, formed during the falling stage of flood discharge as particles are deposited around larger clasts. Klingman and Emmet (1983) noted that more sand and coarse gravel are transported on rising discharge, and more small gravel transported on falling discharge. These observations may explain grain size variations in the coarse-grained sediments.</p> <p>Several miles north of this site is another gravel pit 41-B-14 which is located in an abandoned proglacial drainageway along the southern limit of the Algona advance (see Stop 8, Figure 1, p.142). A stratigraphic sequence very similar to that described at 55 Whittemore SE site is present. At 41-B-14 an abandoned sand and gravel pit exposes 4.4 m (14.5 ft.) of sand and gravel. The section consists of a thin veneer of fine-grained sediments capping a massive to planar bedded pebble gravel which overlies cosets of medium-scale trough crossbedded sand and pebbly sand (Quade,1992). The B-14 stratigraphic sequence is interpreted to have been deposited under flow-regime conditions similar to those that formed the sequence at the 55 Whittemore SE site.</p>
134.4	4.5	To the right is an esker composed of Pilot Knob Mbr. deposits.
134.6	0.2	Stop sign. Turn left on US Hwy. 69 and proceed north.
135.7	1.1	Note esker to the left.
137.0	1.3	Enter Forest City, home of the Winnebago Corporation.
138.4	1.4	Cross Winnebago River. This river heads along the Algona glacial margin and in this area flows behind a hummocky ridge system (category HRS) related to the Altamont glacial advance.
138.5	0.1	Stoplight. Turn right on State Hwy. 9 and leave Winnebago River

- valley. We are now driving through a hummocky ridge system (category HRS) on the up-ice side of the Algona ice margin.
- 141.7            3.2    Turn right on road into Pilot Knob State Park and drive through hummocky ridge system with well expressed linked-depression systems. We are less than 10 miles from the eastern margin of the DML.
- 142.7            1.0    Park entrance. Proceed straight to parking lot. Depart bus and proceed to shelter for lunch. **LUNCH STOP, PILOT KNOB STATE PARK.**

### **Dead Man's Lake**

Dead Man's Lake is one of the most unusual wetlands in Iowa. It has been described as a "bog" by most authors, but is actually a nutrient-poor fen. Fens are separated from bogs by water chemistry, in particular pH, which is obviously a reflection of water source. Bogs have a pH of usually below 4.0 and are fed primarily by rainwater, thus the acidic pH. MacBride described Dead Man's Lake as "fed by springs, cold and clear..." however, while the chemistry reflects some groundwater inputs, it does not match that from the true spring-fed fens in Iowa (MacBride, 1902). The lake itself sits in a small depression on the Altamont ice margin. Local relief is about 45 feet. Details of the local geology are not known, but in general the deposits surrounding the fen are ice-contact glaciofluvial materials. Thus, the permeability may be high enough to allow groundwater to seep to Dead Man's Lake. The surficial drainage basin which probably mirrors the groundwater basin is small, covering only about 25 acres, thus inflow would be limited.

Dead Man's Lake is unusual in that the western part of the lake has a 3-acre floating mat present, dominated by *Sphagnum*. The mat, which once covered most of the lake, has been somewhat reduced in size by cutting and removal in the late 1920s (Grant and Thorne, 1955). The mean thickness of the mat is 2 feet. Its chemistry is somewhat variable depending on the time of year and whether a recent rain has occurred before sampling. The pH of the interstitial water varies from 4.1 to 5.7 in the center of the mat (Smith, 1962). The mat is surrounded by a 'moat' of open water characterized by neutral pH.

Dead Man's Lake is unusual not just because of its chemistry, but because of the plant community which it supports. The eastern part of the lake is primarily open water and supports a typical marsh and lake vegetation. However, the floating mat contains two species, *Carex cephalantha* (sedge) and *Drosera rotundifolia* (sundew), which are found nowhere else in the state (Watson, 1989). An additional three species, *Carex chordorrhiza* (sedge), *Eriophorum gracile* (cotton grass), and *Potentilla palustris* (marsh cinquefoil), are common on the mat, but rare in the rest of the state.

The high acidity and low dissolved oxygen limit the habitat for aquatic organisms. Smith and Bovbjerg (1958) noted low numbers

both for number of species and total individuals in below mat waters. By contrast, however, the number of diatoms species is larger than found in many spring-fed fens and Dead Man's Lake displays different taxa than found in most Iowa fens (Main and Busch, 1992).

A core from the center of the mat showed that the fen developed in the late Holocene, and that the lake was probably intermittently dry in the middle Holocene (R. G. Baker, personal communication).

143.6	0.9	Stop sign. Turn left and proceed west on State Hwy. 9.
146.6	3.0	Enter Winnebago River Valley.
146.8	0.2	Stoplight. Turn left on US Hwy. 69. Just south of the Municipal Airport we rise up onto an elongate, slightly sinuous beaded ridge (esker) that trends roughly east-west from a large, moderate relief, short-slope hummock. This landform complex is part of an elongate, north-south trending hummocky ridge system (category HRS) that marks one of the Altamont advances along the eastern portion of the DML in Iowa. The ridge is bordered on the south by a tributary of the Winnebago River.  The 41 Madison site is located in a gravel pit on the beaded ridge, and exposes Pilot Knob Mbr. deposits. The general stratigraphy consists of two units: stratified meltwater sands and gravels overlain by a 1.5-2 m thick veneer of stratified diamicton (Kemmis, 1991).  Soils mapped on the ridge and hummock complex are complexes of the Clarion and Sunburg series, and the Sunburg and Salida series (Lensch, 1989). Clarion and Sunburg soils are formed in glacial till, while Salida soils are formed in outwash. The Clarion and Sunburg soils at this locality are formed in the stratified diamicton deposits that veneer the ridge. Because the soil thicknesses (0.3 to 1.5 m; 1 to 5 ft) are thinner than the diamicton veneer of 1.5 to 2 m (4 to 6 ft), the soil map neither portrays the thick sands and gravels which are mineable at the site nor gives a complete indication of the material sequence present. This is a common limitation of soil maps on the DML: the shallow depth of mapping (1.5 m or 5 ft) does not accurately indicate the stratigraphic sequence at many sites, and thus soil maps are of limited use for geologic interpretation, land-use planning, and other applied purposes in which it is essential to know properties at depths greater than 1.5 meters.  As we proceed south to Garner we will cross over a series of discontinuous hummocky ridge systems (HRS) and intervening plains with irregular surface patterns (category PS) associated with the Altamont ice margin complex. We also cross the East Branch Iowa River which carried meltwater from both the Altamont and Algona ice margins.
158.0	11.2	Stop sign. Turn left on US Hwy. 18 and proceed east.
158.6	0.6	Cross East Branch Iowa River.
159.0	0.4	Stop sign. Turn right on US Hwy. 69 and proceed south through a plain with linked-depression systems (category PD).

165.5	6.5	Turn right on B55 and proceed west.
166.1	0.6	Cross East Branch Iowa River. This valley is associated with the Algona and Altamont glacial advances.
167.2	1.1	Enter a plain with irregular surface patterns (category PS) once you cross the East Branch, then ascend a hummocky ridge system (category HR). The series of gravel pits to the right are located in the uplands. Pilot Knob Mbr. sand and gravel deposits are being mined from these.
168.4	1.2	Turn left and proceed south on County Rd. R56. Note well developed linked-depression systems on both sides of the highway.
172.2	3.8	Turn right on 130 <sup>th</sup> St.
172.6	0.4	Drop into West Branch Iowa River valley. This drainage line is associated with the southern margin of the Algona glacial advance.
173.0	0.4	Cross West Branch Iowa River.
173.7	0.7	Thompson EMS site to the left. Note basin located down in drainageway.
174.2	0.5	Turn left and proceed south on Nash Ave.
174.4	0.2	<b>Stop 8. Thompson EMS Site.</b> Turn left into entrance to EMS site.
174.9	0.5	Stop sign. Turn left on 120 <sup>th</sup> St and proceed east.
175.5	0.6	On right is the parking lot for Twin Lakes State Wildlife Management Area. These lakes are part of a linked-depression system that joins the West Branch Iowa River. McCulloch Bog, one of Walker's (1966) study areas, is located about 1.5 miles south in this linked-depression system.
175.9	0.4	Cross West Branch Iowa River.
176.9	1.0	Stop sign. Turn right on County Rd. R56 and proceed south through a hummocky plateau area (category HP).
177.9	1.0	Stop sign. Cross County Rd. B63 and proceed south on Page Ave.
179.6	1.7	To left is a large-scale EMS site. The lagoon is situated in part of a linked-depression system that joins the West Branch Iowa River.(see Stop 8, Figure 1, p.142).
179.9	0.3	Turn right on 110 <sup>th</sup> St.
180.3	0.4	To the right is another large-scale EMS site. The lagoon is located at the head of the drainageway of the same tributary we crossed.
182.8	2.5	Stop sign. Turn left on Madison Ave. and proceed south.
184.8	2.0	Stop sign. Cross County Rd. C20 and proceed south on County Rd. R38. Drive up backside of Altamont ice margin complex.
187.6	2.8	Descend Altamont ice margin complex.
187.7	0.1	To the left is a wetland, the site of a plugged ADW and the headwaters of Little Eagle Creek which drains the Altamont ice margin complex.
192.6	4.9	Enter Clarion.
193.4	0.8	Stoplight. Turn left and proceed east on State Hwy. 3.
193.5	0.1	On left note the home of the 4-H emblem.

Jessie Field Shambaugh of Shenandoah was an educator who embraced the ideals of farm living in the early 1900s. She involved

her students in Girls Home Clubs and Boys Corn Clubs. Their award pin was shaped like a clover with an “H” on each leaf.

O.H. Benson, a Clarion educator who established similar clubs in Wright County, took the pin to a national conference, and it eventually became the symbol of farm youth clubs worldwide. The four “H’s” in 4-H represent head, heart, hands, and health.

197.3	3.8	Turn right and proceed south on gravel road Quincy Ave.
197.7	0.4	<b>Stop 9. ADW Site.</b>
198.2	0.5	Turn left on 230 <sup>th</sup> St. and proceed east.
199.2	1.0	Stop sign. Turn right and proceed south on US Hwy. 69.
199.9	0.7	Note EMS sites to the left and right. Wright County has 17% of the permitted EMS on the DML, and 8% of the permitted EMS sites statewide. Permitted EMS sites in Wright County house approximately 410,000 head of hogs. Hogs far outnumber humans, in this county-- <i>at least 30 times to 1.</i>
201.0	1.1	To the left note one of the many ice margins that make up the Altamont ice margin complex. More EMS units to right and left.
202.3	1.3	Poultry facility and grain elevator under construction to the left.
202.9	0.6	Concrete plant and more EMS sites to right.
205.1	2.2	Big Wall Lake to right. Another ice margin of the Altamont complex to the left.
206.9	1.8	Cross Ditch No. 3. Altamont ice margin complex to the left.
207.9	1.0	Ascend back side of Altamont ice margin complex.
210.1	2.2	Hamilton Co. line. We are driving across the crest of the Altamont ice margin complex, a hummocky ridge system in this area (category HRS).
211.2	1.1	EMS units ahead on both sides of road.
215.4	4.2	To right Blairsburg, still driving on Altamont ice margin complex.
216.0	0.6	Bear right and stay on US Hwy. 69.
216.1	0.1	Stop sign. Go straight on US Hwy. 69.
216.2	0.1	Stop sign. Bear left on US Hwy. 69.
216.7	0.5	Sand and gravel pit to right is developed in Pilot Knob Mbr. Altamont complex to right.
217.6	0.9	Cross US Hwy. 20 on overpass. Good view of topography in hummocky ridge system of the Altamont ice margin complex.
222.1	4.5	Another EMS facility to the left. Note Ditch No. 63 to left, a tributary to the South Skunk River.
222.8	0.7	Drop off Altamont ice margin complex. Note more EMS sites on both sides of road. Driving on a plain with irregular surface patterns (category PS).
226.7	3.9	Cross Ditch No. 71, part of an extensive system of linked drainages heading on the Altamont ice margin complex. This system drains to the South Skunk River.
226.9	0.2	Enter Jewell.
228.8	1.9	Ditch No. 71 to left. Ascend plain with rounded circular to irregularly shaped surface patterns (category PR).

229.6	0.8	Little Wall Lake on left.
232.0	2.4	Curve left on US Hwy. 69.
232.8	0.8	Bear right on US Hwy. 69 and proceed south. Note plain with lineated surface patterns transverse to the glacier-flow direction (category PL) to the left.
234.1	1.3	The outermost ice margin of the Altamont glacial advance is to the left in the far distance beyond the South Skunk River Valley.
235.4	1.3	Ahead is a plain with rounded circular to rounded irregular surface patterns (category PR) that slopes gently to the southeast. This area is know as the Story City Flats.
236.5	1.1	Story City to left.
237.4	0.9	Note Altamont ice margin ahead.
238.3	0.9	Artesian Service to right. Note the Keigley Creek valley to right. Numerous artesian wells are located in the Keigley Creek drainage basin (Beyer, 1898). These flowing wells vary in depth from 60 to 100 feet and are developed in Quaternary sands and gravels that are overlain by glacial diamicton. Beyer (1898), reported that at approximately 55 feet a drill dropped nine feet on reaching sand and gravel and that water and gravel spouted out of the drill hole with great violence. Beyer also reported that boulders weighing up to several pounds were hurled out and that the water contained much suspended sediment. Flows of up to 470 gallons per minute were recorded from that well site but Beyer found most of the artesian wells in the vicinity had lower flow rates.
238.8	0.5	Cross branch of Keigley Creek.
239.2	0.4	Ascend backside of Altamont ice margin.
241.2	2.0	Note radio towers to left and front located on the Altamont I crest.
243.3	2.1	Drop off front of Altamont I ice margin. Note discontinuous and poorly expressed ridges ahead in a plain with lineated surface patterns transverse to the glacier-flow direction (category PL).
244.3	1.0	Enter Skunk River valley. Note sand and gravel pits on both sides of road.
245.0	0.7	City of Ames alluvial wells to left. Enter Ames.
247.6	2.6	Stoplight. Turn right on Lincoln Way.
248.3	0.7	Stoplight. Turn left on Elwood Drive.
248.5	0.2	Turn left on Center Drive.
248.9	0.4	Scheman Building parking lot. <b>End Trip.</b>



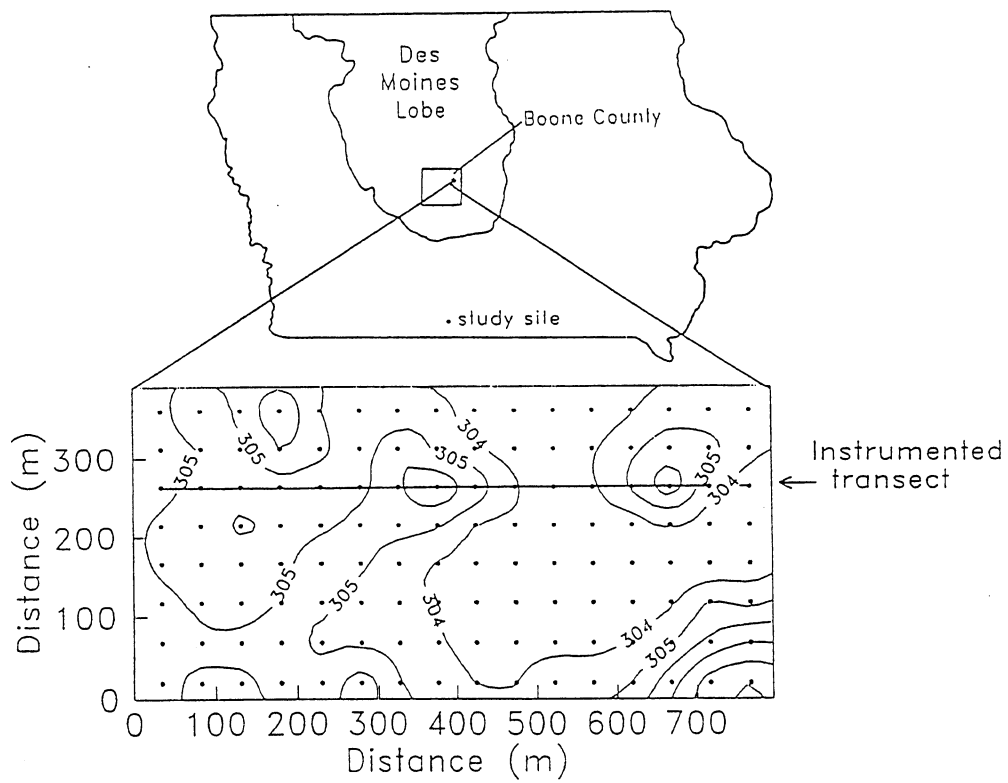
## REFERENCES

- Beyer, S.W., 1898, Geology of Story: Iowa Geological Survey Annual Report, 1898, v. 9, p. 230-232.
- Brayshaw, A.C., 1984, The characteristics and origin of cluster bedforms in coarse-grained alluvial channels, *in* Koster, E.H., and Steel, R.H., eds., *Sedimentology of Gravels and Conglomerates: Canadian Society of Petroleum Geologists Memoirs* 10, p. 77-85.
- Clayton, L., 1967, Stagnant-glacier features of the Missouri Coteau, *in* Clayton, L., and Freers, T.F., eds., *Glacial Geology of the Missouri Coteau and adjacent areas: North Dakota Geological Survey*
- Cross, Aureal T., 1966, Palynologic evidence of mid-Mesozoic age of Fort Dodge (Iowa) gypsum: Geological Society of America, Annual Meeting, Abstract.; Special Paper 101, p. 46.
- Grant, M.L. and Thorne, R.F., 1955, Discovery and Description of a Spahagnum Bog in Iowa, With Notes on the Distribution of Bog Plants in the State: *Journal of Iowa Academy of Science*, v. 62, p. 197-210.
- Kemmis, T.J., 1991, Glacial landforms, sedimentology and depositional environments of the Des Moines Lobe, northern Iowa: University of Iowa Department of Geology, Iowa City, unpublished Ph.D. thesis, 393 p.
- Keys, C.R., 1893, *Gypsum Deposits of Iowa*, Iowa Geological Survey Annual Report, v. 3, p. 257-304.
- Klingeman, P.C., and Emmet, W.W., 1983, Gravel bedload transport processes, *in* Hey, R.D., Bathurst, J.C., and Thorne, C.R., eds. *Gravel-Bed Rivers: Fluvial Processes, Engineering and Management: New York, John Wiley and Sons*, Chapter 7.
- Lensch, R.A., 1989, Soil Survey of Hancock County, Iowa, United States Department of Agriculture, Soil Conservation Service, Washington, D.C., 199 p.
- Ludvigson, G.A., 1996, Paleoclimatic Controls on Detrital Modes of Jurassic and Cretaceous Sandstones, Cratonic Margin, Western Interior Basin (abs.), in press.
- MacBride, T.H., 1902, Geology of Kossuth, Hancock, and Winnebago Counties: Iowa Geological Survey Annual Report, 1899, v. 13, p. 81-122.
- Main, S.P. and Busch, D.E., 1992, Diatoms of northeastern Iowa fens: *Journal of the Iowa Academy of Science*, v. 99, p. 15-22.
- McKay, Robert M., 1985, Gypsum resources of Iowa: Iowa City, Iowa Geological Survey, Iowa Geology 1985, p. 12-15.
- Owen, David Dale, 1852, Report of a geological survey of Wisconsin, Iowa, and Minnesota; and incidentally of a portion of Nebraska Territory: Philadelphia, Lippincott, Grambo & Co., 638 p.
- Parizek, R.R., 1969, Glacial ice-contact rings and ridges, *in*, Schumm, S.A., and Bradley, W.C., eds., *United States Contributions to Quaternary Research: Geological Society of America Special Paper* 123, p. 49-102.
- Quade, D.J., 1992, Geomorphology, sedimentology and stratigraphy of Late Wisconsinan valley-train terraces along the Iowa River in north-central Iowa: University of Iowa Department of Geology, Iowa City, unpublished M.S. thesis, 85 p.
- Ruhe, R.V., 1969, *Quaternary Landscapes in Iowa: Iowa State University Press*, Ames, IA, 255 p.
- Scotese, C.S., 1991, Jurassic and Cretaceous plate tectonic reconstructions: *Palaeography, Paleoclimate, Paleoecology*, v. 87, p. 493-501.
- Simpkins, W.W., Qiu, Z., and Parkin, T.B., 1993, Summary of Hydrogeological and Hydrogeochemical Research at the Ames Till Hydrology Site: Geological Society of Iowa, Guidebook 58, Stop 2, p. 47-67.
- Smith, P.E., 1962, An ecological analysis of a northern Iowa *Sphagnum* bog and adjoining pond: Ph.D. thesis, University of Iowa, Iowa City, 149 p.
- Smith, P.E. and Bovbjerg, R.V., 1958, Pilot Knob Bog as a habitat: *Proceedings of the Iowa Academy of Science*, 64, 546-553.
- Van Zant, K., 1979, Late glacial and postglacial pollen and plant macrofossils from West Lake Okoboji, northwestern Iowa: *Quaternary Research*, v. 12, p. 358-380.
- Walker, P.H., 1966, Postglacial environments in relation to landscape evolution on the Cary drift, Iowa: Iowa State University Agricultural and Home Economic Experiment Station Research Bulletin 549, p. 838-875.
- Watson, W.C., 1989, The vascular flora of Pilot Knob State Preserve: *Journal of the Iowa Academy of Science*, v. 96, p. 6-13.
- White, C.A., 1870, Gypsum and other Sulphates of the Alkaline Earths. *in* White, C.A.(ed.), *Geology of Iowa*, v. 2, Chapter II, pp. 293-306.





**STOP DISCUSSIONS  
AND DESCRIPTIONS**



**Figure 1.** Location of study site in Boone County, Iowa, and layout of sampling grid for south field on a contour map. Dots denote sampling points. Contour interval = 1 m.

# **STOP 1: LANDSCAPE EVOLUTION OF A TILL LANDSCAPE IN THE CLARION-NICOLLET-WEBSTER SOIL ASSOCIATION AREA IN CENTRAL IOWA**

Leaders: Thomas E. Fenton and Aaron L. Steinwand

The objective of this study was to describe landscape evolution and soil-landscape relationships for soils in a glaciated landscape in Iowa. Geomorphic and stratigraphic maps and cross sections were prepared using characterization data from 192 soil cores collected from a 64-ha site in Boone County. Sampling depth was based on the depth to the unoxidized and unleached till. It ranged from 2 to 7 m. One transect crossing several hillslopes was instrumented with 47 piezometers to determine groundwater flow direction. Three strata of surficial sediments overlying till were identified. The upper two strata were slope alluvium deposited after 4,300 years before present (YBP), which limits the age of the soils to the late Holocene or younger. The lower sediment resembled alluvium and may be supraglacial sediment draped on the till and later eroded from adjacent hillslopes. The hydrology was characterized by recharge under topographic highs, lateral groundwater flow on sideslopes, and discharge in swales. During dry periods, however, portions of higher swales acted as recharge areas and groundwater flow was directed between swales.

## **BACKGROUND**

The Clarion-Nicollet-Webster (CNW) catena occupies approximately 31,000 km<sup>2</sup> and is the most extensive suite of soils on the Des Moines Lobe. Soil taxonomic differences are largely due to differing parent material texture, carbonate status, and moisture regime. These properties are controlled by past erosion-deposition processes on the landscape and the near-surface hydrology.

Studies of Holocene paleoenvironments have suggested that 3,000 to 4,000 YBP marked a change to more humid conditions in central Iowa (Van Zant, 1979; Kim, 1986; Van Nest and Bettis, 1990) and possibly the entire Midwest (McDowell, 1983). Landscape instability during this period resulted in accumulation of mineral sediment in bogs (Walker, 1966). Wallace and Handy (1961) described stone lines on Cary till. Burras and Scholtes (1987) identified surficial sediment on the Des Moines Lobe till and concluded that it was derived from adjacent hillslopes. The sediment is the parent material for most of the CNW catena and is undated except by correlation with sediments contained in bogs.

## **METHODS**

The study site is a 64-ha tract located in northeastern Boone County in central Iowa (Figure 1). The site is in the CNW soil association area and the landscape is typical of low relief undulating topography that characterizes large areas of the Des Moines Lobe (Table 1). The site is cultivated and is artificially drained with subsurface clay tile. The sampling design consisted of a 48.8 m (160 ft.) grid on the south 32-ha field and a 97.6 m (320 ft.) x 48.8 m area on the north 32-ha field. Elevations were determined with a transit and rod and recorded for each grid intersection. At each grid intersection a 5-cm diameter core was extracted using a hydraulic soil probe. A total of 128 cores were collected in the south field

**Table 1.** Classification and drainage class for soil series of the Clarion-Nicollet-Webster catena located at the study site.

Soil Series	Classification	Drainage Class*
Clarion	Fine-loamy, mixed, mesic Typic Hapludoll	WD
Nicollet	Fine-loamy, mixed, mesic Aquic Hapludoll	SWP
Webster	Fine-loamy, mixed, mesic Typic Endoaquoll	PD
Canisteo	Fine-loamy, mixed (calcareous), mesic Typic Endoaquoll	PD
Delft	Fine-loamy, mixed, mesic Cumulic Endoaquoll	PD
Harps	Fine-loamy, mesic Typic Calciaquoll	PD
Okoboji	Fine, montmorillonitic, mesic Cumulic Endoaquoll	VPD

\*VPD very poorly drained; PD poorly drained; SWP somewhat poorly drained; MWD moderately well drained; WD well drained.

and 64 cores in the north field. Sampling depth was based on the depth to unoxidized unleached till and ranged from 2 to 7 m. Cores were wrapped in waxed freezer paper, taken to the laboratory and placed in cold storage until described. A buried soil surface horizon (Ab) was found in 19 cores. Two bulk soil samples of the Ab horizons were radiocarbon dated.

One east-west grid line was instrumented with 47 piezometers in 16 nests (approximately three per nest) spaced at 48.8 m intervals. The transect crossed several hillslopes and all major soils. The deepest piezometer of each nest was placed in unoxidized and unleached (UU) till except when the borehole collapsed at two locations where thick, sandy sediments overlie till. Shallow and intermediate piezometers were constructed in fractured, oxidized till or in overlying coarse-textured sediments. Piezometers were 3.2 cm inner diameter PVC pipe with a sealed bottom and perforations in the lower 25 cm. The PVC pipe was placed in the hole after extraction of a 5-cm diameter soil core. The longest core from each nest was collected and brought to the laboratory for characterization. Water levels were monitored approximately biweekly from May 1989 to June 1993 with an electric line meter.

Detailed descriptions of soil morphology (Soil Survey Staff, 1993) and parent material (Hallberg et al., 1978) were completed for each core. Redoximorphic features were described according to Brewer (1964) but are discussed herein using the terminology of Vepraskas (1994). Each soil core was classified at the soil series level including drainage class (Soil Survey Staff, 1990) and subsampled for laboratory analysis. Controlled stratigraphic sections were prepared from morphologic description and particle-size data.

Particle-size distribution of the <2.0-mm fraction was determined by the pipette method after pretreating for organic matter with 30% hydrogen peroxide, dispersing with sodium hexametaphosphate, and shaking on a reciprocating shaker overnight (Walter et al., 1978). Sand fractionation was performed by mechanical dry sieving. Particle-size analysis was performed on 67 cores; 16 were from the piezometer transect.

**Table 2.** Morphologic descriptions of Facies 1 through 4.

---

Facies 1A	<u>Oxidized</u> : loam, light olive brown (2.5Y 5/4)*, massive to moderate plate-like structure due to horizontal fractures, fracture spacing 2 - >10 mm, RDMF** common as linings on fractures and masses adjacent to fractures (quassiferrans of Brewer, 1964), strongly eff. <u>Unoxidized</u> : loam, dark gray (5Y 4/1), massive, rarely fractured except in upper few cm, RDMF rare and restricted to fracture linings, strongly eff.
1B	Sandy loam to silt loam (rare), typically light olive brown (2.5Y 5/5) but variable, stratified to massive, noneff. to strongly eff.
Facies 2	Stratified sand to sandy loam in swales, variegated color, gravel common, noneff. to strongly eff., very rare Fe-Mn concentrations.
Facies 3	Sandy loam to silt loam, light brownish gray (2.5 Y 6/2), massive or weak subangular blocky, frequently stratified with alternating 2-4 cm thick beds of silt loam/very fine sandy loam and sand, silt maximum at base, Fe-Mn concentrations along bedding planes, noneff. to strongly eff.
Facies 4	Clay loam to silty clay loam with few grains >1mm, parent material for PD and VPD soils, RDMF consist of Fe-depleted matrices and rare Fe-Mn concentrations.

---

\* All colors are for moist parent material

\*\* RDMF is redoximorphic features

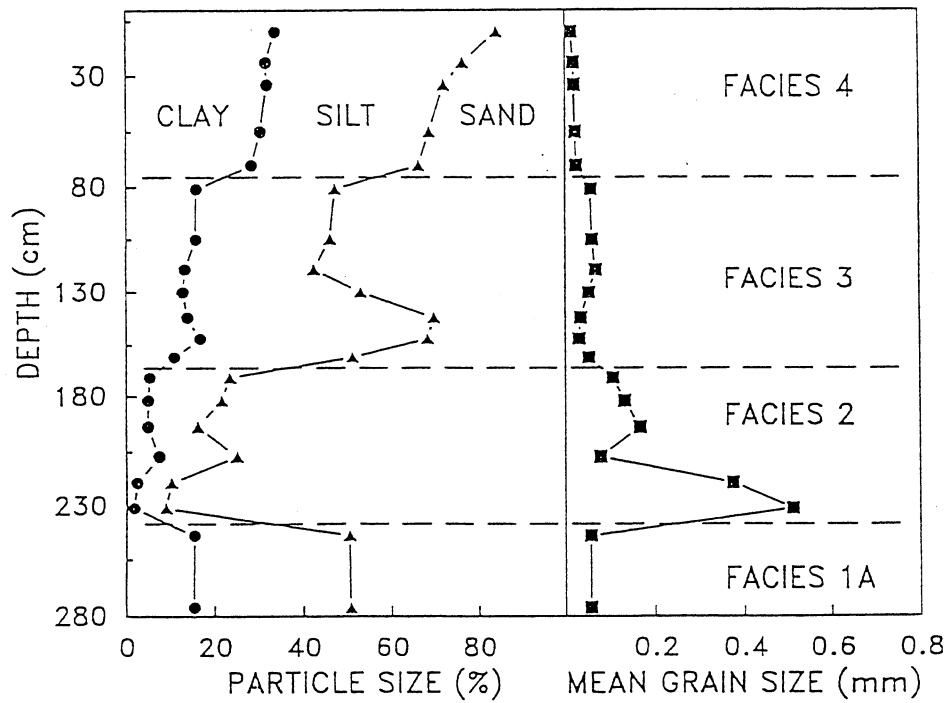
## RESULTS AND DISCUSSION

### Geomorphic Evolution

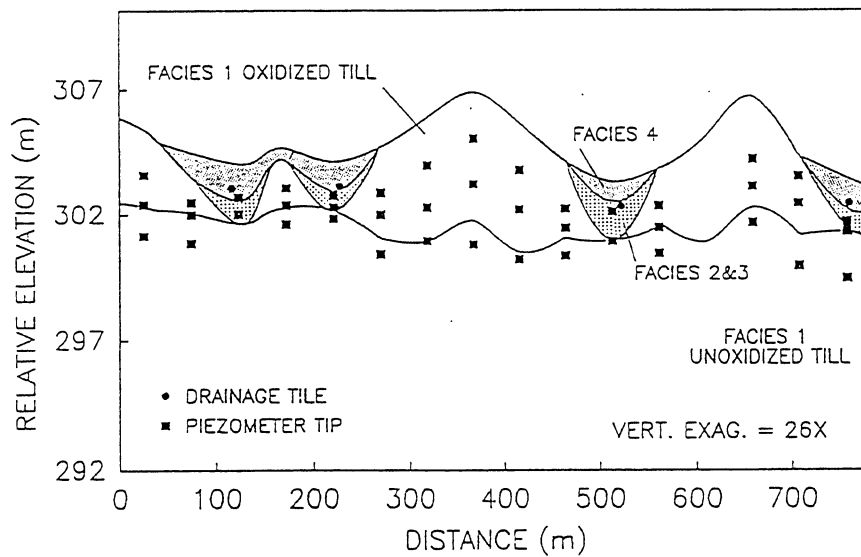
Four lithostratigraphic units were identified and assigned informal facies designations (Table 2; Figure 2). Facies distribution was examined by constructing cross sections and contour maps of the facies surfaces (Figure 3). Elevations of the minor moraine ridges are constant for each contour and surface map. Facies 1 underlies the entire site and is the principle material in minor moraine ridges. Facies 2, 3, and 4 were restricted to swales and generally thickened toward the center (Figures 2 and 5).

Facies 1 is a Wisconsinan Des Moines Lobe glacial deposit. The dominant unit, Facies 1A, is subglacially deposited till (basal till; Alden Mbr. of Dows Fm.) with an upper oxidized-reduced weathering zone and a lower unoxidized weathering zone. The surface of the basal till is irregular, with several small depressions that later accumulated sediment. These partially filled depressions form the larger swales between minor moraines (Figure 4). Facies 1B is variably textured and weakly stratified supraglacial till (Morgan Mbr. of Dows Fm.). It is restricted to the summit of some minor moraines. Similar sediments were described in more detail by Kemmis et al. (1981).

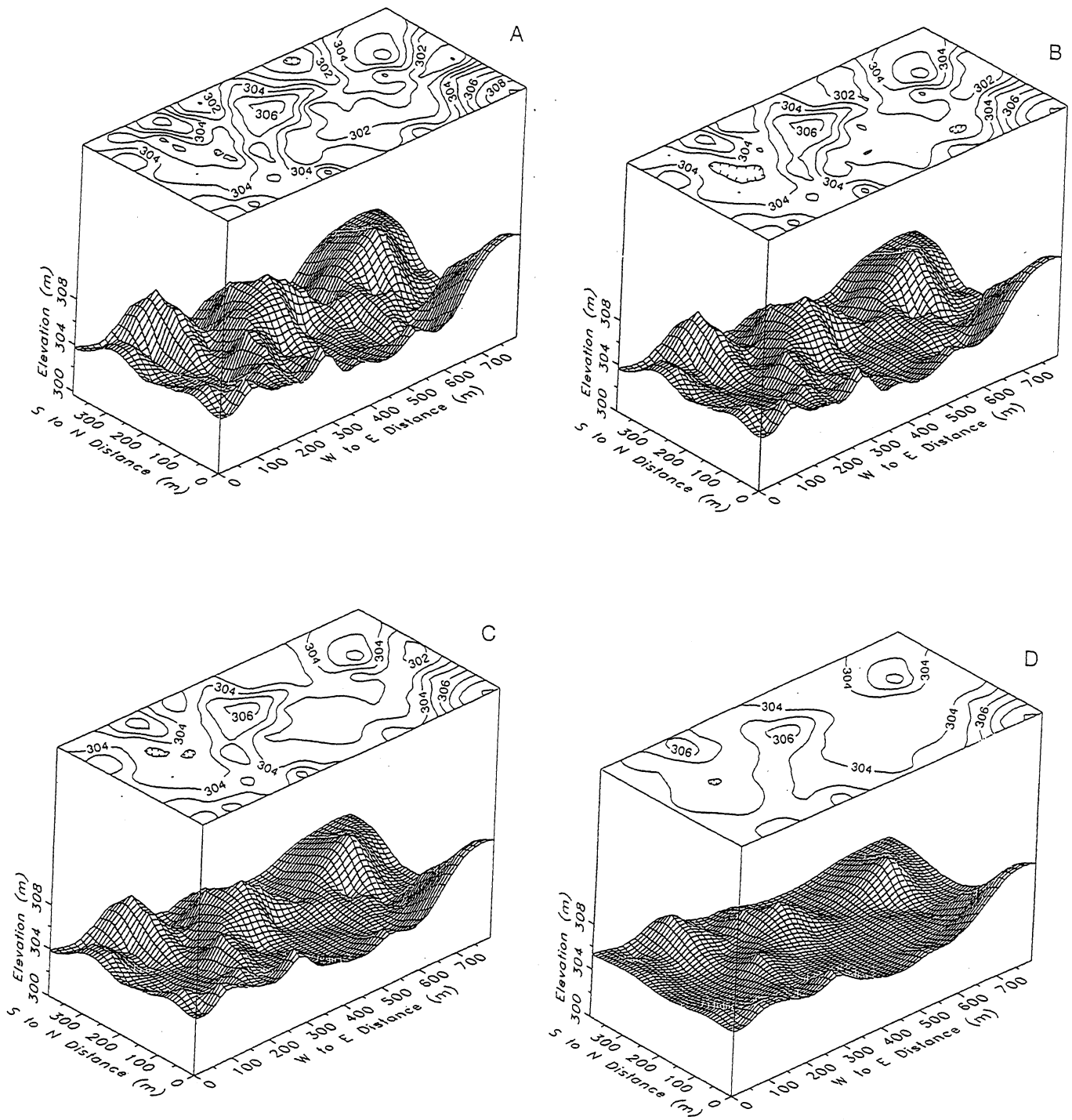
The physical properties of Facies 2 resemble fluvial deposits. These include the fining upward of the mean particle size (Figure 3), stratification, and well-sorted, sandy textures



**Figure 2.** Particle-size distribution and mean particle size (<2-mm fraction) of a typical profile intersecting Facies 1 through 4; facies boundaries indicated by dashed lines.

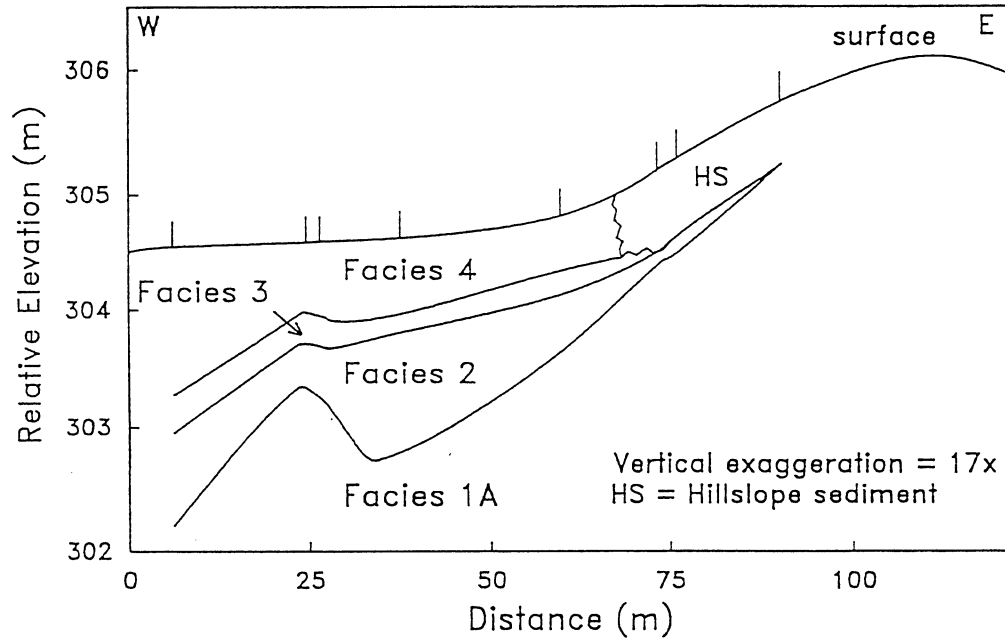


**Figure 3.** Cross section of transect instrumented with piezometers, showing piezometer and approximate tile line locations and the stratigraphy of till weathering zones and overlying sediment facies.



**Figure 4.** Surface net and contour diagrams of the geomorphic surfaces: (A) Facies 1 (till) surface; (B) Facies 2 surface; (C) Facies 3 surface; (D) Facies 4 surface (current topography); elevation relative to local benchmark, vertical exaggeration = 25X, contour interval = 1 m.





**Figure 5.** Stratigraphic cross section of Facies 1 through 4 along a hillslope transect; vertical bars denote sampling locations.

(Moss and Walker, 1978). No buried channel incised into the surface of the basal till could be identified (Figure 4). Thus, the sediment probably was not deposited in postglacial stream channels like those described by Jahn (1975) and Pennock and Vreeken (1986). The absence of any defined channels also rules out deposition in channels eroded beneath the ice (Stewart et al., 1988) or at the ice margin (White, 1953). Stratigraphic and geomorphic evidence indicates that deposition was related to the surface of the underlying basal till (Figures 4 and 5). Facies 2 is thickest where it filled small depressions on the basal till. Clear correspondence between the thickness of a sediment and the underlying surfaces suggest a colluvial-slope alluvial origin (Ruhe et al., 1971). *Slope alluvium* is defined as sediment deposited on or at the base of hillslopes by moving water, either concentrated in rills or gullies or by sheet flow (Soil Survey Staff, 1993). Facies 2 may be slope alluvium mixed with and derived from a thin mantle of coarse-textured till from backslopes and some summits, followed by deposition across lower land positions. This hypothesis is consistent with the physical properties and geomorphology of Facies 2 and with the preservation of Facies 1B on some summits. It also is easily reconciled with an ice stagnation model describing Des Moines Lobe deposition (Kemmis, 1991).

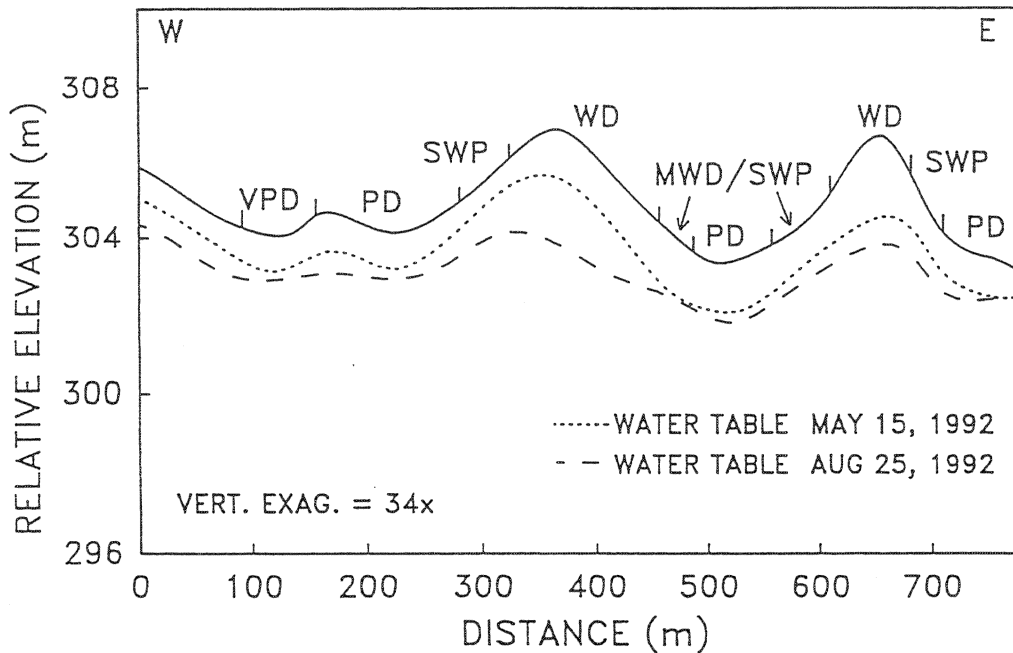
Facies 3 and 4 were interpreted to be related deposits of slope alluvium. Both facies fill landscape depressions and Facies 3 frequently merges laterally and vertically (usually gradational boundaries) with the lower part of Facies 4 on toeslopes and footslopes (Figure 5). Facies 4 may merge laterally with coarser surficial sediments on hillslopes as described by Walker (1966). This facies is correlated with the surficial fine sediment described more completely by Burras and Scholtes (1987). Radiocarbon dates of  $4290 \pm 150$  (Beta-52537) and  $4370 \pm 120$  YBP (Beta-58732) were obtained from soil organic matter in Ab horizons

**Table 3.** Time during which horizons were saturated and soil morphology for representative profiles from soil morphology-saturation classes. Shaded horizons denote shallowest horizon with low-chroma redoximorphic features.

Horizon	Depth* (cm)	Time sat. (%)	Moist color	Redoximorphic features **
Class 1, well drained on shoulder; Clarion series, Fine-loamy, mixed, mesic Typic Hapludoll				
AB	53	6	2.5Y 4/4	c1f 2.5Y 3/2
Bw1,2	88	18	2.5Y 4,5/4	f1f 10YR 5/8
BC	97	21	2.5Y 4,5/4	c1d 10YR 6/8, f2-1d 10YR3/3
C1,2	140	34	2.5Y 5/4	c1d 10YR 6/8 and 5/8, c1d 2.5Y 6/2
C3	185	48	2.5Y 5/4	c2d 10YR 4/6, f1d 10YR 5/8, f1d 2.5Y 6/2
Class 2, poorly drained on lower footslope; Delft series, Fine-loamy, mixed, mesic Cumulic Endoaquoll				
A	42	2	10YR 2/1	
Bg1	77	12	10YR3/1	
Bg2	98	23	5Y 5/2	
Cg1	114	36	5Y 5/2	m1f 5Y 5/3, c1p 10YR 5/8
Cg2	129	49	5Y 5/2	m1f 5Y 5/3, c1p 10YR 5/8
Cg3	157	69	2.5Y 5.5/2	c1d 2.5Y 5/6, f1p 10YR 5/8
C1	184	76	2.5Y 5/4	m2d 5Y 6/1, c1-2d 10YR 5/8
Class 3, somewhat poorly drained on footslopes; Nicollet series, Fine-loamy, mixed, mesic Aquic Hapludoll				
Bw	53	1	2.5Y 3/2	f1f 2.5Y 5/4
BC	64	2	2.5Y 4/2	f1f 2.5Y 5/4
Cg1	84	6	2.5Y 5.5/2	m1f 2.5Y 5/5, c1p 10YR 5/8
Cg2	110	16	2.5Y 6.5/2	c1p 10YR 5/8, f1f 2.5Y 5/5
Cg3	152	31	2.5Y 6/2	m2p 10YR 5/8, c1p 7.5 YR 4/6, c1-2d 2.5Y 4/4
Class 4, very poorly drained in depression; Okoboji series, Fine, montmorillonitic mesic Cumulic Endoaquoll				
A1	65	1	10YR 2/1	
A2	85	9	10YR 2/1	
A3	100	55	10YR 2/1	
AB	120	71	10YR 3/1	f1f 2.5Y 5/2, f1f 2.5Y 5/4

\* Depth to bottom of horizon.

\*\* Abundance: few (f), common (c), many (m); size: fine (1) <5 mm, medium (2) 5 to 15 mm, large (3) >15 mm; contrast: faint (f), distinct (d), and prominent (p).



**Figure 6.** Water table depth along the instrumented transect for May and August 1992, representing a high and low water table, respectively; vertical bars denote soil boundaries. YPD, very poorly drained; PD, poorly drained; SWP, somewhat poorly drained; MWD, moderately well drained; and WD, well drained.

at the top of Facies 2. Facies 3 is present at one site but absent at the other because it merges with the base of Facies 4 downslope (Figure 5). The similar dates and stratigraphic evidence suggested that the start of facies 3 and 4 depositions was almost contemporaneous about 4300 YBP and that Facies 3 is probably a coarser textured subunit deposited at the onset of the later erosional-depositional episode. Radiocarbon dates of soil organic matter represent the mean residence time of organic C in the dated material and only approximate the date of burial. The dates, however, clearly place deposition of Facies 3 and 4 and the genesis of the CNW catena in the Late Holocene, supporting the correlation of sediments in upland and bog environments (Walker, 1966).

### Hydrology

Hydrology and water table-soil morphology relations were examined by contouring hydraulic head measurements along the instrumented transect and by comparing the water table fluctuations with the soil horizon morphology (Table 3).

Water levels in shallow and intermediate piezometers in jointed, oxidized till and postglacial sediments responded to expected seasonal fluctuations, but fluctuations in deep piezometers in unjointed UU till were smaller and occurred at later dates (Figure 6). This was attributed to the differences in hydraulic conductivity of the two weathering zones (Hendry, 1988; Jones et al., 1992). Data from piezometers in unjointed UU till were excluded from contouring. Water table elevations were derived from either the shallow piezometer (when

not dry) or from intermediate piezometer readings.

The water table mirrored the surface topography during wet periods. Hydraulic head contours were essentially vertical with only small downward gradients (recharge) under summits during high water table periods (Steinwand, 1992). Groundwater flows in the fractured till and overlying sediments was laterally toward discharge areas in swales between adjacent topographic highs. The presence of an interconnected fractured network and coarse-textured sediments above a very slowly permeable boundary probably promoted lateral flow and discharge in swales (Ruland et al., 1991; Winter, 1988). Identification from hydrologic data of discharge sites within swales was confounded by the presence of tile drains, but the long-term hydrologic regime is reflected in the distribution of soils on the landscape (Arndt and Richardson, 1988). Observations support the predominance of lateral flow in the CNW catena, but shorter lived reversals of flow probably occur around small depressions within swales during ponding. These depressions are often surrounded by Harps soils (Calcicquolls), suggesting a local hydrologic regime similar to that described by Arndt and Richardson (1993). Additional details on the relationship of soils and water levels are given in Steinwand and Fenton (1995).

## SUMMARY

Soils, sediments, and hydrology of a low-relief minor moraine area on the Des Moines Lobe were investigated to develop a conceptual model of soil-landscape evolution and shallow hydrology. Four stratigraphic units were identified. The lowermost unit is Dows Fm. glacial deposits that underlie the entire site and are the dominant material composing minor moraines. Three facies overlying the till are restricted to swales between minor moraines. The upper two facies were interpreted to be Late Holocene (<4,300 YBP) slope alluvium deposited by runoff directed toward swales from adjacent hillslopes. The lower facies may be Early Holocene slope alluvium derived from relatively coarse-textured supraglacial meltwater sediments now preserved on more stable summits. The proposed hypothesis accounts for the stratigraphic and morphologic observations and is easily reconciled with current regional ice stagnation models of the Des Moines Lobe deposition.

Soil-hydrologic relationships of a Mollisol catena were investigated by examining the groundwater flow directions and soil distribution along several hillslope transects. The predominant groundwater flow was laterally from topographic highs toward adjacent swales. This flow regime was probably promoted by the stratigraphy of postglacial sediments and weathering zones in the till. The water table did not parallel the surface topography at low water levels, suggesting that throughflow occurs in part of some swales but not others. This promoted the genesis of well drained and moderately well drained to somewhat poorly drained soil at lower elevations and lower hillslope positions adjacent to a swale with better natural drainage.



## REFERENCES

- Arndt, J.L., and Richardson, J.L., 1988, Hydrology, salinity, and hydric soil development in a North Dakota prairie-pothole wetland system: *Wetlands*, v. 8, p. 93-108.
- Arndt, J.L., and Richardson, J.L., 1993, Temporal variations in the salinity of shallow groundwater from the periphery of some North Dakota wetlands (USA): *J. Hydrol. (Amsterdam)*, v. 141, p. 75-105.
- Brewer, R., 1964, *Fabric and mineral analysis of soils*: John Wiley & Sons, New York.
- Burras, C.L., and Scholtes, W.H., 1987, Basin properties and postglacial erosion rates of minor moraines in Iowa: *Soil Sci. Soc. Am. J.*, v. 51, p. 1541-1547.
- Hallberg, G.R., Fenton, T.E., and Miller, G.A., 1978, Standard weathering zone terminology for description of Quaternary sediments in Iowa, in Hallberg, G.R. (ed.), *Standard procedures for evaluation of Quaternary materials in Iowa*: Iowa Geological Survey Technical Information Series No. 8, p. 75-109.
- Hendry, M.J., 1988, Hydrogeology of clay till in a prairie region of Canada: *Ground Water*, v. 26, p. 607-614.
- Jahn, A., 1975, *Problems of the periglacial zone*: Natl. Sci. Found., Washington, D.C.
- Jones, L., Lemar, T., and Tsai, C.T., 1992, Results of two pumping tests in Wisconsin age weathered till in Iowa: *Ground Water*, v. 30, p. 529-538.
- Kemmis, T.J., 1991, *Glacial landforms, sedimentology, and depositional environments of the Des Moines Lobe, northern Iowa*: University of Iowa, Department of Geology, Iowa City, PhD dissertation (Diss. Abstr. 91-36947).
- Kemmis, T.J., Hallberg, G.R., and Lutenecker, A.J., 1981, Depositional environments of glacial sediments and landforms on the Des Moines Lobe: *Iowa Geological Survey Guidebook 6*, 132 p.
- Kim, H.K., 1986, *Late glacial and Holocene environment in central Iowa: a comparative study on pollen data from four sites*: University of Iowa, Department of Geology, Iowa City, Ph.D. dissertation (Diss. Abstr. 86-28118).
- McDowell, P.F., 1983, Evidence of stream response to Holocene climatic change in a small Wisconsin watershed: *Quat. Res.*, v. 19, p. 100-116.
- Moss, A.J., and Walker, P.H., 1978, Particle transport by continental water flows in relation to erosion deposition, soils, and human activities: *Sediment. Geol.*, v. 20, p. 81-141.
- Pennock, D.J., and Vreeken, W.J., 1986, Soil-geomorphic evolution of a Boroll catena in southwestern Alberta: *Soil Sci. Soc. Am. J.*, v. 50, p. 1520-1526.
- Ruhe, R.V., Miller, G.A., and Vreeken, W.J., 1971, Paleosols, loess sedimentation, and soil stratigraphy, in Yaalon, D.H. (ed.), *Paleopedology: origin, nature and dating of paleosols*: Israel Univ. Press, Jerusalem, p. 41-60.
- Ruland, W.W., Cherry, J.A., and Feenstra, S., 1991, The depth of fractures and active groundwater flow in a clayey till plain in southwestern Ontario: *Ground Water*, v. 29, p. 405-417.
- Soil Survey Staff, 1990, *Keys to soil taxonomy* (4th ed.): Soil Manage. Support Serv. Tech. Monogr. 19, Virginia Polytech. Inst. and State Univ., Blacksburg.
- Soil Survey Staff, 1993, *National soil survey handbook*: U.S. Gov. Print. Office, Washington, DC.
- Steinwand, A.L., 1992, *Soil geomorphic, hydrologic, and sedimentological relationships and evaluation of soil survey data for a Mollisol catena on the Des Moines Lobe, central Iowa*: Iowa State University, Ames, IA, Ph.D. dissertation (Diss. Abstr. 92:34850).
- Steinwand, A.L., and Fenton, T.E., 1995, Landscape evolution and shallow groundwater hydrology of a till landscape in central Iowa: *Soil Sci. Soc. Am. J.*, v. 59, p. 1370-1377.
- Stewart, R.A., Bryant, D., and Sweat, M.J., 1988, Nature and origin of corrugated ground moraine of the Des Moines Lobe, Story County, Iowa: *Geomorphology*, v. 1, p. 111-130.
- Van Nest, J., and Bettis, E.A., III, 1990, Postglacial response of a stream in central Iowa to changes in climate and drainage basin factors: *Quat. Res.*, v. 33, p. 73-85.
- Van Zant, K., 1979, Late glacial and postglacial pollen and plant macrofossils from West Lake Okoboji, northwestern Iowa: *Quat. Res.*, v. 12, p. 358-380.
- Vepraskas, M.M., 1994, *Redoximorphic features for identifying aquic conditions*: North Carolina Agric. Res. Serv. Tech. Bull. 301, North Carolina State Univ., Raleigh.
- Walker, P.H., 1966, Postglacial environments in relation to landscape and soils on the Cary drift, Iowa: *Iowa Agric. Home Econ. Exp. Sta. Res. Bull.*, v. 549, p. 838-875.
- Wallace, R.W., and Handy, R.L., 1961, Stone lines on

- Cary Till: Proc. Iowa Acad. Sci., v. 68, p. 372-379.
- Walter, N.F., Hallberg, G.R., and Fenton, T.E., 1978, Particle size analysis by Iowa State University Soil Survey Laboratory, *in* Hallberg, G.R. (ed.), Standard procedures for evaluation of Quaternary materials in Iowa: Iowa Geological Survey Technical Information Series No. 8, p. 61-90.
- White, E.M., 1953, Subsoil textural variations on the Clarion-Webster-experiment farm as related to the Mankato glacial deposit: Iowa Acad. Sci. Proc., v. 60, p. 438-441.
- Winter, T.C., 1988, A conceptual framework for assessing cumulative impacts on the hydrology of nontidal wetlands: Environ. Manage. (NY), v. 12, p. 605-620.

## **STOP 2: NATIONAL GYPSUM CO., KAUFFMAN-GEORGE PIT, FORT DODGE, IOWA**

Leaders: E. Arthur Bettis III, Deborah J. Quade, Donald P. Schwert,  
Holly J. Torpen, and Richard G. Baker

***PLEASE STAY AWAY FROM THE VERTICAL WALLS EXPOSED ON  
EITHER SIDE OF THE RAMP AT THIS STOP. THE QUARRY  
OPERATORS HAVE GRANTED US PERMISSION FOR THIS VISIT  
CONTINGENT ON NO ONE BEING NEAR THE HIGH WALLS.***

### **INTRODUCTION**

The Kauffman-George Quarry is the only quarry currently supplying the Georgia-Pacific Corporation's mill south of Fort Dodge. The quarry was opened in 1973 and has been in continuous operation since. Gypsum produced at the Kauffman-George Quarry is trucked about 9 miles to the Georgia-Pacific mill and wallboard plant south of Fort Dodge.

At this stop we will examine the Morgan and Alden members of the Dows Fm., examine and discuss the Dows Fm./Sheldon Creek Fm. contact, as well as paleoenvironmental interpretations derived from fossil plant and insect assemblages preserved in sediments at the Dows/Sheldon Creek contact. Several active gypsum pits in the Fort Dodge area, outcrops along Brushy Creek southeast of Fort Dodge, and excavations for an earthen dam at Brushy Creek State Recreation Area, located 19 km south of Stop 2 have provided us with a good look at the complete sedimentary sequence of the Dows Formation in a low-relief plain with irregular surface patterns (PU) landform area of the Lobe. This area is within the part of the Lobe covered by the Altamont advance, and a few kilometers southeast of the Clare Moraine.

### **STRATIGRAPHY**

Figure 1 presents a graphic log of the stratigraphic sequence exposed in the National Gypsum pit in late July 1995. The quarry is active and lateral expansion is at a fast rate, so the details of the stratigraphic sequence, and the nature and occurrence of sub-Dows deposits during the field trip visit may differ from those depicted in Figure 1. In this area the Dows Fm. consists of relatively thick, dense, uniform Alden Mbr. diamicton that changes abruptly upward to stratified diamicton and sorted sediments of the Morgan Mbr. Morgan Mbr. deposits exposed in the eastern wall of the ramp in 1995 consisted primarily of sorted sediments—trough cross-bedded medium to coarse pebbly sands with interbedded lenses and pods of diamicton. Individual beds of the sorted sediments were offset by normal faults, probably formed by collapse of underlying sediments during melting of buried ice.

The Morgan Mbr. is jointed through its vertical extent (4.3 m), with thin discontinuous coatings of iron and reduction zones along some joint faces in the oxidized zone of the weathering profile. The oxidized/unoxidized weathering zone transition is rather abrupt here and coincides with the lower boundary of abundant sorted sediments in the Morgan Mbr. Jointing continues into the unoxidized weathering zone, but at an intensity much less than higher in the weathering profile. In the unoxidized zone thin oxidation fronts extend from



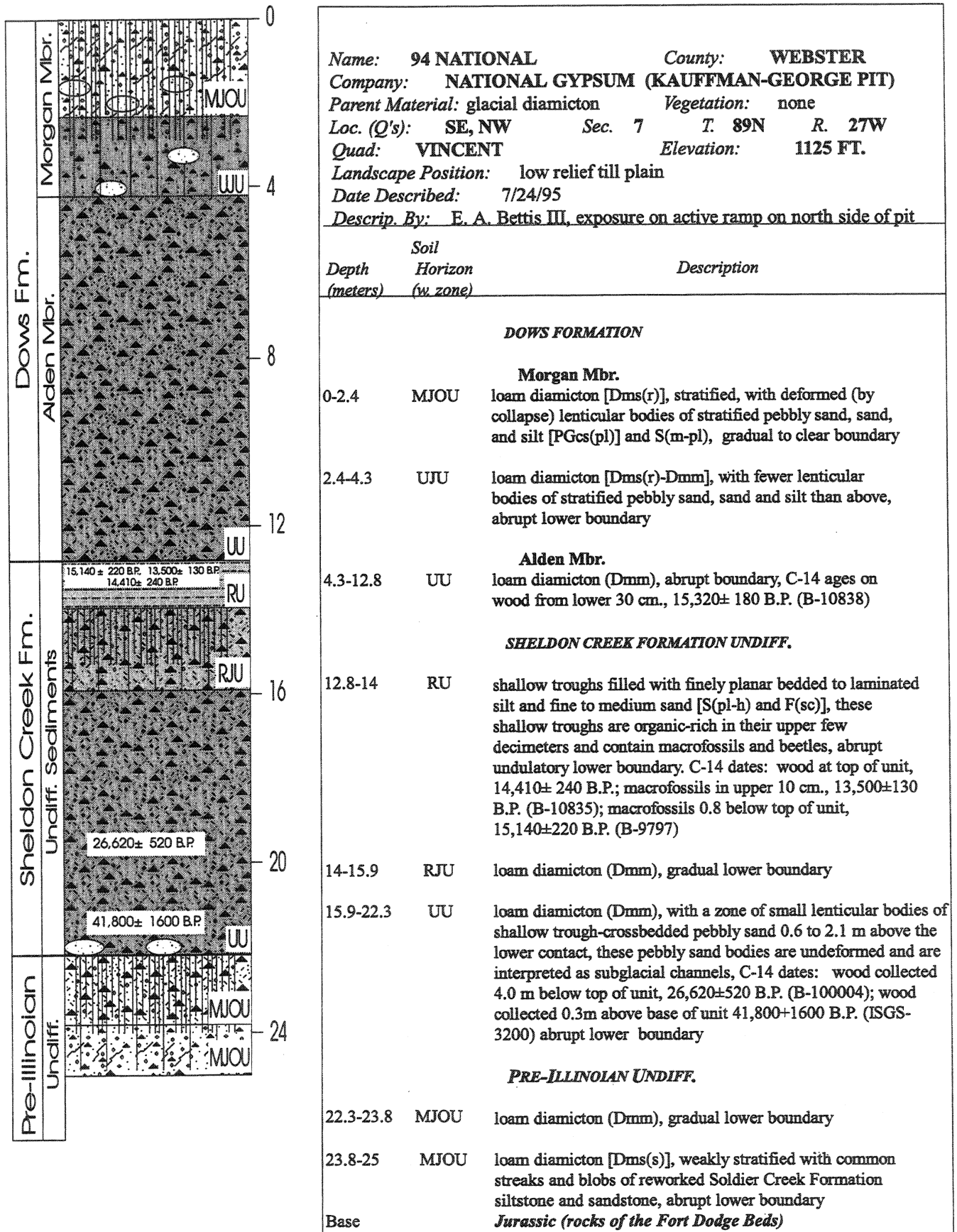


Figure 1. Graphic log of the stratigraphic sequence exposed in the National Gypsum Quarry, Fort Dodge, Iowa.

joint faces into the unoxidized matrix.

Dows Fm. deposits abruptly overlie planar bedded to laminated silt and fine to medium sand that were deposited in small, shallow ponds on the pre-Des Moines Lobe surface of the Sheldon Creek Fm. These pond sediments fill shallow troughs that range from about 40 cm to 1.5 m in depth. Small-scale deformation structures (water escape features, small normal faults and small folds), formed when the area was overridden by the glacier that deposited the Dows Fm., are common in these sediments.

The pond sediments contain at least two horizons of organic enrichment that include plant and insect fossils. The upper-most organic horizon gives way laterally to an A/C soil profile developed on thin silty sediments that grade downward into Sheldon Creek Fm. diamicton. The upper two meters of the Sheldon Creek Fm. is jointed and reduced. The organic horizons, interpreted as incipient soils, jointing, and a reduced (as opposed to unoxidized) weathering zone indicates that Sheldon Creek Fm. deposits were exposed to subareal weathering and soil development before they were buried by Dows Fm. diamicton. The nature of the soils developed in and on the pond sediments, and the presence of jointing (formed by desiccation of the clay-rich diamicton), and a reduced weathering zone (originally an oxidized zone that was later subjected to an oxygen-poor environment) in the underlying Sheldon Creek Fm. diamicton suggest that the conditions on the pre-Lobe landscape became more poorly drained as the glacier advanced into this area. The presence of these soils and weathering profile also indicate that little or no subglacial erosion or deformation took place as the Lobe advanced across this area. Other gypsum pits in the Fort Dodge area, clay pits along the Des Moines Valley south of Fort Dodge, and outcrops in Brushy Creek State Recreation Area expose Dows Fm./Sheldon Creek Fm. sequences very similar to that exposed at the Kauffman-George pit. This preservation of the pre-Dows Fm. surface over a relatively large area (at least 150 km<sup>2</sup>) indicates similar, non-erosive conditions at the base of the Des Moines Lobe glacier as it advanced across this area.

Radiocarbon ages on organic remains collected during 1984 at this stratigraphic position by George Hallberg from the lower 20 cm of the Dows Fm. (15,310±80 B.P.— B-10838 on wood) and in the pond sediments below the Dows Fm. (15,140±220 B.P.— B-9797 on macrofossils) indicate that the Lobe advanced across this area about 15,200 years ago. Younger radiocarbon ages from the pond sediments (13,500±130 B.P.—B-9796 and 14,410±240—B-9877) are judged erroneous in the regional chronologic context. These “too young” ages may be a product of abundant moss in the dated samples; mosses are known to yield young radiocarbon ages (MacDonald et al., 1987).

Beneath the pond sediments, the Sheldon Creek Fm. consists of massive, uniform, dense diamicton interpreted as basal till. The lower 2.1 meters of the unit contains small, lenticular bodies of shallow trough cross-bedded pebbly sand that are interpreted as subglacial channels. Wood collected by Hallberg in 1984, 2.3 m above the base of the Sheldon Creek Fm., yielded a radiocarbon age of 26,620±520 B.P. (B-10004) while another wood sample collected in 1995, 0.3 m above the base of the unit yielded a radiocarbon age of 41,800±1600 BP (ISGS-3200). Sheldon Creek Fm. diamicton abruptly overlies oxidized, jointed, and unleached Pre-Illinoian diamicton, which in turn buries Fort Dodge Fm. rocks comprised of reddish siltstone (Soldier Creek beds) and the underlying Fort Dodge gypsum (Figure 1). Though we will not examine the Jurassic rocks during this trip, we provide the following description of the exposed portion of the Fort Dodge Fm. (Table 1).

**Table 1.** Description of exposed portion of Fort Dodge Fm., National Gypsum Corporation Kauffman-George Quarry, Fort Dodge, Iowa.

---

**National Gypsum Corporation**  
**Kauffman-George Quarry**  
 SW¼, SE¼, section 7, T.89N., R.27W.  
 west end of north wall, east-west cut  
 section measured by Robert McKay and Raymond Anderson  
 June 19, 1995

<b>Unit</b>	<b>description</b>	<b>Thickness (m)</b>
<b>Pre-Illinoian Glacial Diamicton</b>		
8.	Yellow-brown, oxidized, leached, small sand lenses, basal 0.6 m mixed with Soldier Creek lithologies and boulders.	~2.0
<b>Fort Dodge Formation</b>		
<b>Soldier Creek beds</b>		
7.	Mudstone, red / green mottled, calcareous, disturbed fabric suggestive of soil formation	0.3 - 0.5
6.	Sandstone, yellow - light brown, v.fine- to fine-grained with minor medium to coarse, calcareous, well-cemented to friable, minor clay flakes, lensoid 2.2 m x 0.6 m, cross-section of channel trending ~ N-S, one of multiple channels around quarry at same stratigraphic level, lateral equivalent of Unit 5.	0.6
5.	Mudstone, red, calcareous, non-laminated, calcite nodules to 3 cm in lower 0.3 m of unit.	1.0
4.	Mudstone, buff to red-brown mottled, calcareous, sandy (fine to medium).	0.3
3.	Silt, greenish-brown with red mottles near top, uncemented, very calcareous, sharp basal contact.	0.2
<b>Fort Dodge gypsum</b>		
2.	Gypsum, white with mm scale gray bands, maximum of 1.8 m of erosional relief in top of gypsum as solution-enlarged joints to 1 m wide, 0.2 m of water in sump (to base of gypsum), 1.2 m from sump water to quarry floor, 4.5 m of gypsum from floor to uneroded top.	5.9
<b>Sub-gypsum claystone</b>		
1.	Claystone, very dark gray to black, calcareous, some mm-scale layering, brick red stains along horizontal and vertical fractures, trenched to 0.5 m but quarry crew reports drainage ditches to 2.5 m within unit.	2.5

# INSECT REMAINS: A FACETED EYE'S PERSPECTIVE ON THE ADVANCE OF THE DES MOINES LOBE INTO NORTH-CENTRAL IOWA

Donald P. Schwert and Holly J. Torpen

## Introduction

The organic-rich sediments underlying the Dows Fm. contain remarkably rich quantities of beetle (Coleoptera) chitin. Also present in these sediments are remains of other insect orders (Hemiptera, Homoptera, Trichoptera, Ephemeroptera, Diptera, and Hymenoptera), erigonid spiders, oribatid mites, cladoceran ehippia, and aquatic snails. Schwert (1992), in a preliminary report on the fauna, listed some of the beetle species identified from the quarry's sediments.

The insect assemblages at Fort Dodge are among the most stratigraphically significant yet encountered in the late Wisconsinan record. Their occurrence immediately below the Dows Fm. implies that they are evidence of insect faunas that occupied the landscape of north-central Iowa as ice of the Des Moines Lobe advanced into this region. Indeed, at one of the sites (Section II), insect-bearing organics appeared to be sheared into the diamicton. Collectively, the Fort Dodge assemblages thus present a perspective on the environment and climate of this region prior to and during ice advance.

## Sample Section, Ages, and Procedures

Sampling of sub-diamicton organics at the National Gypsum Quarry for insect analyses occurred on two occasions. In July 1984, a team (D.P. Schwert, G.R. Hallberg, R.G. Baker, A.C. Ashworth, D.G. Horton, and others) obtained organics from two sections of freshly-stripped quarry overburden. The first (Section I) section of organic sands from the east wall was sampled in bulk; fragments of wood and of mosses (*Scorpidium scorpoides*; field determination by D.G. Horton) were encountered in these samples. The second section (Section II) of organic silts from the central portion of the north quarry wall was sampled in 10-cm intervals, from 0 cm (diamicton contact) to 50 cm. In 1995, Art Bettis sampled sub-diamicton organics from fresh exposures in the quarry overburden; these samples are still being processed for insect remains.

As of this writing, radiocarbon dates have been obtained from organics derived from the July 1984 sampling, but not the 1995 sampling (Table 2). Included in this list are  $^{14}\text{C}$ -AMS dates on minute quantities (0.20 - 0.31 mg) of unidentifiable beetle chitin, undertaken to test whether chitin is appropriate for dating. In addition to these four dates, two others exist on sub-diamicton organics sampled by G.R. Hallberg in June 1984, from exposures on the east wall of the quarry:  $14,410 \pm 240$  B.P. (Beta-9877; wood and plant fragments at contact with diamicton) and  $15,140 \pm 220$  B.P. (Beta-9797; plant debris and disseminated organic carbon 0.8 - 1.0 m below contact with diamicton). G.R. Hallberg (pers. comm., 1984) estimated that the organic units for these latter two dates were approximately stratigraphically equivalent (in their relationships to the overlying diamicton) but about 20 m distant from those of Section I due to active stripping of the quarry overburden. Overall, the precise relationships among the three sections sampled in 1984 remain unclear.

**Table 2.** Coleoptera identified from sub-diamicton sediments at the National Gypsum Quarry, Fort Dodge, Iowa.<sup>a</sup>

	Skeletal parts:			Minimum # of individuals:				
				Section I	Section II Interval (cm)			
					0-10	10-20	20-30	30-40
<b>Carabidae:</b>								
<i>Opisthius richardsoni</i> Kby.		P	L			1		
<i>Notiophilus aquaticus</i> (L.)	H	P	L R	1		1		
<i>Elaphrus americanus</i> Dej.			R				1	
<i>Elaphrus californicus</i> Mann.	H	P	L R			5	3	
<i>Elaphrus</i> sp.		P			1			
<i>Loricera pilicornis</i> (F.)	H	P	L			2	2	
<i>Dyschirius</i> spp. (2)	H	P	L R	5	1	2		
<i>Miscodera arctica</i> (Payk.)	H	P		1				
<i>Bembidion grapii</i> Gyll.		P	L R	3		7	3	
<i>Bembidion sordidum</i> (Kby.)	H	P	L R	5		8	4	
<i>Bembidion petrosum</i> Gebl.	H	P	L R			5	2	
<i>Bembidion nigripes</i> (Kby.)	H	P	L R			7		
<i>Bembidion mutatum</i> G. & H.		P	L R	4		2		1
<i>Bembidion morulum</i> LeC.		P	L R	5		2		
<i>Bembidion</i> spp. (6)	H	P	L R	5		7	6	5
<i>Agonum anchomenoides</i> Rand.	H	P	L R		1	7		
<b>Dytiscidae:</b>								
<i>Hydroporus</i> cf. <i>griseostriatus</i> (DeG.)	H	P	L R			7	3	
<i>Hydroporus</i> spp. (2)	H	P	L R			5		
<i>Agabus arcticus</i> (Payk.)	H	P	L R			8		1
<i>Colymbetes</i> sp.			L			1		
<b>Hydrophilidae:</b>								
<i>Helophorus sempervarians</i> Angus	H	P	L R			16		
<i>Helophorus arcticus</i> Brn.	H	P	L R	1		4		
<i>Helophorus</i> sp.		P	L R			2		2
<i>Laccobius</i> sp.	H	P	L R			11		
<i>Cercyon</i> sp.			L R			2		
<b>Limnebiidae:</b>								
<i>Ochthebius</i> sp.	H	P	L R		2	72	5	12
<b>Staphylinidae:</b>								
<i>Oxytelus</i> or <i>Anotylus</i> sp.	H	P					1	
<i>Olophrum consimile</i> Gyll.		P	L R			2		
<i>Bledius</i> spp. (2)	H	P	L R	5		14	1	
<i>Stenus</i> spp. (3)	H	P	L R		1	45	2	1
<i>Philonthus</i> cf. <i>subvirescens</i> Thoms.	H	P	L R				5	
<i>Philonthus</i> sp. ( <i>aurulentus</i> grp.)	H	P	L R			8	9	
<i>Philonthus</i> spp. (2)	H	P	L R			2		
<i>Mycetoporus</i> sp.			L R	3				1
<i>Tachinus jacuticus</i> Popp.			tergite			5		
<i>Tachinus elongatus</i> Gyll.			tergite			1		
<i>Tachyporus</i> sp.			tergite	1				
Aleocharinae gen. indet.		P	L R					
						20		
<b>Silphidae:</b>								
<i>Thanatophilus</i> sp.	H	P	R		1	2		

Table 2. contd.

	Skeletal Parts:				Minimum # of individuals:				
					Section I	0-10	Section II Interval (cm)		1995
						10-20	20-30	30-40	
Scarabaeidae:									
<i>Aphodius</i> spp.	H	P	L	R	5	1	5		1
cf. <i>Cyphon</i> sp.			L	R			1		
Byrrhidae:									
<i>Simplocaria</i> sp.	P	L	R			4			
<i>Curimopsis</i> sp.		L	R			2			
Heteroceridae:									
Gen. indet.	P	L	R			1	10	10	4
Elateridae:									
<i>Negastrius</i> sp.	P					1			
Gen. indet.	P	L	R			2	1		
Cantharidae:									
Gen. indet.	P	L				6			
Coccinellidae:									
<i>Hippodamia caseyi</i> Johns.			L	R		1			
Chrysomelidae:									
<i>Plateumaris</i> sp.				R		1			
<i>Phaedon</i> sp.		P		R					1
<i>Altica</i> spp. (2)	H	P		R		3			
Gen. indet.			L	R	2				
Curculionidae:									
Bagoini gen. indet.			L	R		3			
Gen. indet.	H	P	L	R	2	6	4		
Scolytidae:									
<i>Polygraphus rufipennis</i> (Kby.)			L			1			
<i>Pityophthorus</i> sp.		P	L			1			

<sup>a</sup>Numbers in parentheses refer to the number of indeterminate species within a taxon. Skeletal parts are abbreviated: H = head, P = prothorax, L = left elytron, R = right elytron. Minimum number of individuals listed are based on the most abundant skeletal part.

Insect chitin was isolated from the July 1984, and 1995 samples utilizing standard kerosene flotation procedures (Elias, 1994). Chitinous remains were sorted under a binocular dissection microscope, with the diagnostic beetle remains being mounted with gum tragacanth onto micropaleontological slides for identification purposes. Other chitinous remains were stored in ethanol. All insect fossils are repositied in the Quaternary Entomology Laboratory, North Dakota State University.

Taxonomic analysis of the chitinous remains was accomplished through morphologic comparison with modern, pinned specimens of beetles. The remains of several taxa were submitted to expert systematists for identification or verification.

### Faunal Syntheses

A comprehensive list of Coleoptera identified from Fort Dodge is presented in Table 2. Included are the results of our recent reevaluation of beetle chitin obtained during the 1984 sampling.

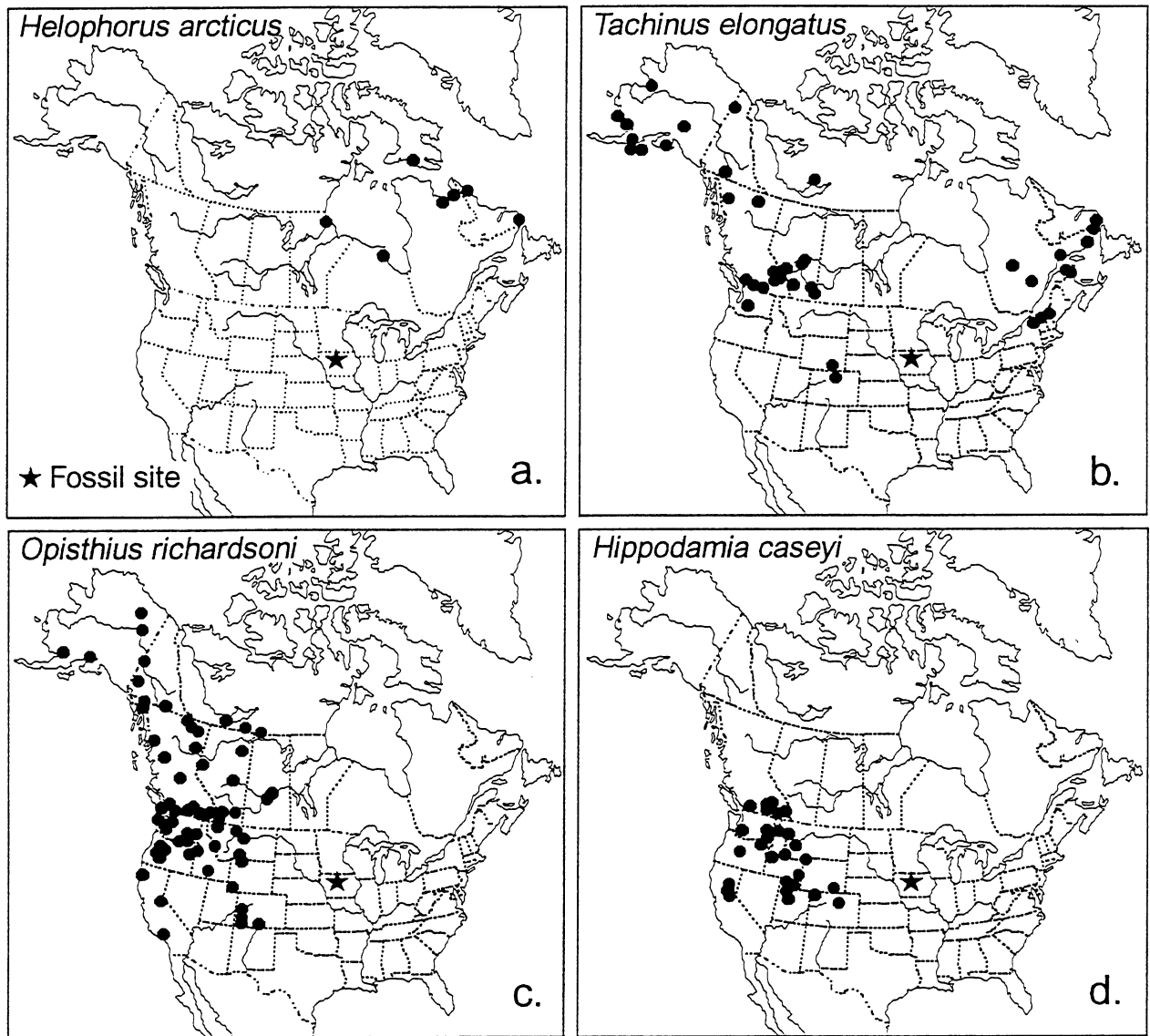
Seventeen families of beetles have been identified. A strong aquatic element is represented, particularly in the Section II and 1995 assemblages, with the rich presence of dytiscids (predaceous diving beetles) and hydrophilids (water scavenger beetles), plus water-marginal taxa of Carabidae (ground beetles), Staphylinidae (rove beetles), Limnebiidae (minute moss beetles), and Heteroceridae (variegated mud-loving beetles). These taxa are regularly associated with pools and shallow ponds bordered by open silty-sand margins, where the surface is only sparsely covered by sedges, grasses, and mosses; such habitats are common on floodplains. Present as well at Fort Dodge is the carabid *Opisthius richardsoni*, a large, riparian beetle today common only on sandy-gravels of braided stream and point bar deposits (Ashworth and Schwert, 1991).

Wood was encountered as bits of twigs and other pieces in both the Section II and 1995 samples, suggesting only a minimal regional presence of trees, possibly dwarfed. This conclusion is supported by the profound open-ground nature of the beetle assemblages. Of the hundreds of chitinous remains so far analyzed, only three are of scolytids (bark beetles); of these, *Polygraphus rufipennis* is regularly associated with conifers (Bright, 1976).

Despite the implied differences in the ages of the Section I and Section II assemblages, the taxa represented are remarkably consistent. Except for its lower diversity and sparser occurrence of water beetles, nearly all of the Section I taxa are present in Section II. Likewise, all of the taxa so far identified from the 1995 samples are represented in Section II.

In contrast to other, older late Wisconsinan assemblages within the region (Elkader, IA - Woodman et al., in press; Conklin Quarry, Iowa City, IA - Baker et al., 1986; lowermost Saylorville, IA - Schwert, 1992), the assemblages at Fort Dodge are nearly devoid of obligate arctic (Type I, per Schwert, 1992) beetles. The only such taxon represented is the hydrophilid *Helophorus arcticus* (Figure 2a), a species that has been reported from numerous full-glacial and late-glacial assemblages in the Midcontinent (Morgan, 1989). More typical of the Fort Dodge beetle assemblages are species, such as the staphylinid *Tachinus elongatus* (Figure 2b), with ranges throughout boreal and montane forest zones but not onto tundra.

A Cordilleran element is likewise present in the Fort Dodge assemblages. The carabid *Opisthius richardsoni* (Figure 2c) today is common along the margins of cold, meltwater-fed rivers in western North America (Ashworth and Schwert, 1991) - environments that would have been common in a landscape flushed with glacial meltwaters associated with the Des Moines Lobe advance and retreat. Less easily explained is the occurrence of the coccinellid



**Figure 2.** Modern distributions of beetles represented as fossils at Fort Dodge, Iowa. (Sources: Campbell, 1973; Gordon, 1985; Ashworth and Schwert, 1991).



(ladybird beetle) *Hippodamia caseyi* (Figure 2d), a predaceous beetle of western, montane distribution whose biology remains poorly known.

## Discussion

The Fort Dodge insect assemblages provide evidence that regionally the Des Moines Lobe advanced into an open, almost treeless landscape of shallow pools and meltwater-fed streams. Although the vegetational structure must have resembled taiga or tundra, the Fort Dodge insects show few affinities to these biomes. The profoundly “cold” and “arctic” aspect demonstrated by the full-glacial faunas at Elkader, IA (Woodman et al., in press) and Conklin Quarry, Iowa City, IA (Baker et al., 1986) is absent in the assemblages at Fort Dodge. Instead, those at Fort Dodge share close affinities to late-glacial faunas, such as those represented at Norwood, MN (Ashworth et al., 1981), Two Creeks, WI (Morgan and Morgan, 1979), Kewaunee, WI (Garry et al., 1990), and Ontario E-13 (Schwert, 1992), where non-arctic, open-ground elements are mixed with those of Cordilleran affinities. In our preliminary analyses of insect assemblages at other sub-diamicton sites (Alden and Brushy Creek) within the region, we have likewise encountered only beetle assemblages of late-glacial affinities.

Thus, present in this “glacial” setting of continental ice advancing into a tundra-like landscape were insect faunas of distinctly “non-glacial” affinities. The arctic insect species that had characterized the late Wisconsinan, full-glacial climate of the Midcontinent had by now been extirpated by climatic warming (Schwert and Ashworth, 1988; Schwert, 1992). From refugia to the south, insect faunas of more temperate affinities advanced northward, probably to the ice margin, itself.

Although paleoentomological analyses can obviously have no direct application to glacial physics or the dynamics of ice response, those at Fort Dodge and associated sites nonetheless provide strong evidence that the advance of the Des Moines Lobe was triggered by the termination of full-glacial climatic conditions. Exactly when and how quickly this climatic transition occurred remains equivocal. “Arctic” insect faunas were present at Conklin Quarry (Iowa City, IA) through at least 16,700 B.P. (Baker et al., 1986). If the 15,310 ± 180 B.P. (Beta-10838) date of Section II organics and associated, non-arctic insects at Fort Dodge is validated by future dating at this site, it temporally delimits both the extirpation event and the termination of late Wisconsinan full-glacial climatic conditions.

# POLLEN AND PLANT MACROFOSSILS

Richard G. Baker

## Introduction

The organic loams at the Dows-Sheldon Creek contact contain locally abundant plant macrofossils and sparse pollen. These plant remains must represent the vegetation present as glacial ice of the Des Moines Lobe advanced across the site. The plant record is of interest not only for revealing the vegetation of this interesting time, but also for how it compares with the insect record.

The sites were sampled first by R.G. Baker, G.R. Hallberg, D.P. Schwert, A.C. Ashworth, D.G. Horton, with help from students from North Dakota State University. Art Bettis resampled the sediments at the same stratigraphic horizon in 1995 after the original section had been cut back considerably.

The plant macrofossils were soaked in water with detergent, washed through sieves (0.5 and 0. mm mesh), and picked by hand using a dissection microscope. All samples collected in 1984 were 300 ml in volume; the 1995 sample was 100 ml. The samples are listed per these volumes. The pollen sample was treated in standard fashion using KOH, HCL, acetolysis solution, and HF, stained with safranin, and mounted in silicone fluid (Faegri et al., 1989). Both pollen and macrofossils were identified using reference collections at the Geology Department, University of Iowa, Iowa City, Iowa, and fossils specimens are repositied in the Repository there.

Radiocarbon ages on the organic remains have been discussed previously. Ages of 15,310 ±80 BP (Beta-10838) and 15,140±220 BP (Beta-9797) are considered to represent the age of these fossils.

## Results

The pollen spectrum of the one sample counted is simple: 55% Cyperaceae (sedge) and 45% *Picea* (spruce). No other pollen type makes up even 1% of the sample. These very minor types include *Alnus* (alder), *Betula* (birch), *Salix* (willow), Poaceae (grass family), *Artemisia* (sagebrush), and Asteraceae (daisy family).

The plant macrofossil samples include analyses from four sections from the 1984 collections (one with five levels) and the 1995 collection. The taxa in these analyses are arranged by ecological grouping, so that readers can understand their significance (see Table 4). The groupings are arctic, boreal, wetland, aquatics, and other.

## Discussion

Comparison of the pollen and plant macrofossils shows some interesting patterns. The pollen sample yields quite a different picture from the plant macrofossils. The dominance of spruce pollen is in contrast with the almost complete lack of spruce needles (one needle out of 2500 ml of sediment). Where spruce is present, it is common to find hundreds to thousands of spruce needles/liter of sediment. This assemblage suggests that spruce was not growing in the immediate vicinity, but it was probably present on some upland areas in the vicinity.

The high sedge pollen fits well with the many *Carex* and *Eleocharis* (spike-rush, another sedge genus) macrofossils. These, along with such wetland taxa as *Equisetum* (horsetail),

**Table 3.** Plant macrofossils at the 1995 Fort Dodge exposure, Sheldon-Dows Contact (R.G. Baker, analyst).

Level		Dows/Sheldon contact	0-10	10-20	20-30	30-40	40-50		
Date collected		1995	1984	1984	1984	1984	1984	1984	1984
Sec. no.		EAB	Sec. 1	Sec. 2	Sec. 2	Sec. 2	Sec. 2	Sec. 3	Sec.4
<b>Arctic</b>									
	<b>fossil type</b>								
<i>Dryas integrifolia</i>	leaves	12	1					58	16
<i>Dryas integrifolia</i>	stems + leaves	2						some	
<i>Juncus triglumis (s.l.)</i>	seeds	53							
<i>Salix arctica</i> type	leaves	15							
<i>Salix</i> sp. A	microphyllous leaves	5							
<i>Salix</i> sp. B	microphyllous leaves	8							
<i>Vaccinium uliginosum</i> var. <i>alpinum</i>	leaves							5	2
cf. <i>Vaccinium uliginosum</i> var. <i>alpinum</i>	leaf fragments	8						30	
other small leaf fragments		25						4	3
immature small leaves (2mm whole leaves long)		11							
small twigs		27							
<b>Boreal</b>									
<i>Picea</i>	needles					1			
<b>Wetland</b>									
<i>Carex aquatilis</i> type									1
<i>Eleocharis palustris</i> type	fruits	1 cf.	1	9		13			4
<i>Equisetum</i> subgen.	stem fragments	common							
<i>Hippochaete</i>									
<i>Juncus</i> sp.	seeds	9	7	1		122	57	2	1
<i>Ranunculus cymbalaria</i>		1 cf.				74	9		
<i>Scheuchzeria palustris</i>	fruits		2						
<i>Triglochin maritimum</i>	fruits	10		2		1		1	
<b>Aquatics</b>									
<i>Myriophyllum</i>	fruits			1					
<i>Potamogeton alpinus</i>	fruits			8		3			
<i>Potamogeton filiformis</i>	fruits	1			1	13	7		
<i>Potamogeton</i> sp.	fruits					1			1
<i>Ranunculus aquatilis</i>	fruits			1			1		4
<i>Chara</i>								present	present
								present	present
<b>Other</b>									
<i>Carex (biconvex)</i>	fruits	69		177	4	234	66	30	1
<i>Carex (trigonous)</i>	fruits	27	3	2		2		65	
small composite	fruits	1							
<i>Draba</i>	siliques								2
grass	caryopsis						1		
<i>Rumex</i>	fruits						2		
<i>Salix</i>	buds	2				19		7	
<i>Salix</i>	capsule bases	33				7		17	
<i>Salix</i>	stipules	4							
unknowns		27							

*Scheuchzeria palustris* (scheuchzeria), *Triglochin maritimum* (arrow-grass), *Juncus triglumis* (rush), *Juncus* sp. (rush), and *Ranunculus cymbalaria* (seaside crowfoot) suggest that a wetland complex was present. The diverse moss flora indicates that many of the low-lying areas supported rich fen vegetation (D.G. Horton, personal communication), which is where many of the sedges, arrow-grass, scheuchzeria, and rushes probably grew. Both upland and pond environments also existed locally, as indicated by both sediments and beetle remains. *Dryas integrifolia* (mountain avens) is a typical pioneer on calcareous gravelly upland habitats, and *Vaccinium uliginosum* var. *alpinum* (bilberry) grows in both upland and moist sites. Pond sites are recorded by *Myriophyllum* (water-milfoil), *Potamogeton* spp. (pondweeds), *Ranunculus aquatilis* (an aquatic crowfoot), and *Chara* (an algae). Several of the wetland and aquatic taxa tolerate relatively high alkalinity (Kantrud et al., 1989), suggesting that runoff may have been composed of fairly hard water. This is not surprising considering the proglacial setting.

The macrofossils of arctic species do not show up in the pollen record at Fort Dodge, but that is fairly typical. These include *Dryas integrifolia* (mountain avens), *Vaccinium uliginosum* var. *alpinum* (arctic bilberry), *Juncus triglumis* (rush), and *Salix arctica* type (arctic willow). These and many other arctic species produce very little pollen. Thus, the species that do produce great amounts of pollen (e.g., the sedges), and pollen fallout from trees some distance from the point of deposition, easily overwhelm the local pollen production.

As with the insects, the combined pollen and plant macrofossil record differs significantly from records from both older and younger sediments. Sites dating from about 16,500 to 21,000 B.P. have a more diverse flora of arctic plant macrofossils, and a pollen record dominated by pine, spruce, and sedge, rather than just spruce and sedge (e.g., Baker et al., 1986). This has been interpreted as a much more open landscape, because 1) insects, vertebrates, and plant macrofossils from that time are all treeline to arctic, and 2) pine apparently was absent from the Midwest, and pollen production was low enough that pine pollen blowing in from the southeastern U.S. comprised 20-30 percent of the total pollen counted. At least that much pine presently is found well beyond treeline in the arctic.

Between about 11,000 and 14,000 B.P., both pollen and plant macrofossils are dominated by spruce and sedge in Iowa (e.g. Baker et al., in press) and across much of the Midwest (e.g., Watts and Winter, 1966). Arctic macrofossils are limited to sites near the ice margin in Minnesota, and in southern Minnesota they are minor elements of a mainly boreal biota (Ashworth et al., 1981).

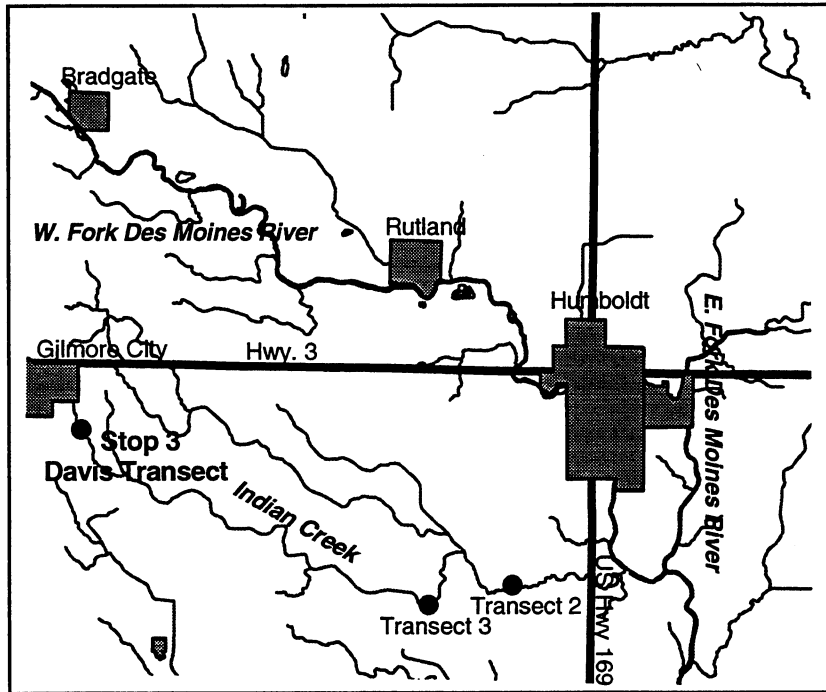
There are few sites dating from the 14,000 to 16,500 B.P. range, and the Fort Dodge site suggests that this was a period of transition. Although the Des Moines Lobe was advancing, the pollen and plant macrofossil record suggests that "arctic" conditions were no longer present, and that spruce was probably abundant on many upland sites. This transition may be a continental expression of the climatic and oceanographic changes seen in oceanic sediments and ice cores at about 14,500 B.P., resulting in the last major Heinrich event in the North Atlantic (Bond et al., 1992; Mayewski et al., 1994).

The contact between the Dows and Sheldon Creek formations appears to be marked by surfaces with some plants in growth position. These suggest that the local landscape was a mosaic of small ponds, fens, other wetlands, and drier upland surfaces that were seldom flooded. The continued presence of arctic plant macrofossils may have depended on more local conditions of disturbance and perhaps cold microhabitats. These microhabitats may have been caused by cold air drainage down local lows, or by cooler conditions adjacent to meltwater streams.



## REFERENCES

- Ashworth, A.C., Schwert, D.P., Watts, W.A., and Wright, H.E., Jr., 1981, Plant and insect fossils at Norwood in south-central Minnesota: a record of late-glacial succession: *Quaternary Research*, v. 16(1), p. 66-79
- Ashworth, A.C., and Schwert, D.P., 1991, On the occurrences of *Opisthius Richardsoni* Kirby and *Asaphidion Yukonense* Wickham (Coleoptera, Carabidae) as Late Pleistocene fossils: *Proceedings of the Entomological Society of Washington*, v. 93(2), p. 511-514.
- Baker, R.G., Bettis, E.A. III, Schwert, D.P., Horton, D.G., Chumbley, C.A., Gonzalez, L.A., and Reagan, M.K., in press, Holocene Paleoenvironments of northeast Iowa: *Ecological Monographs*.
- Baker, R.G., Rhodes, R.S., II, Schwert, D.P., Ashworth, A.C., Frest, T.J., Hallberg, G.R., and Janssens, J.A., 1986, A full-glacial biota from southeastern Iowa, USA: *Journal of Quaternary Science*, v. 1, p. 91-107.
- Bond, G. and 13 others, 1992, Evidence for massive discharges of icebergs into the glacial Northern Atlantic, *Nature*, v. 360, p. 245-249.
- Bright, D.E., Jr., 1976, The bark beetles of Canada and Alaska: The insects and arachnids of Canada and Alaska, Part 2: Agriculture Canada Publication 1576, Ottawa.
- Campbell, J.M., 1973, A revision of the genus *Tachinus* (Coleoptera: Staphylinidae) of North and Central America: *Memoirs of the Entomological Society of Canada*, v. 90, p. 1-137.
- Elias, S.A., 1994, Quaternary insects and their environments: Smithsonian Institution Press, Washington, D.C., 284 p.
- Faegri, K., Kaland, P.E., and Krzywinski, K. 1989, *Textbook of pollen analysis*: John Wiley and Sons, New York.
- Garry, C.E., Baker, R.W., Schwert, D.P., and Schneider, A.F., 1990, Environmental analyses of a Twocreekan-aged beetle (Coleoptera) assemblage from Kewaunee, Wisconsin: *Geological Society of America Special Paper 251*, p. 57-65.
- Gordon, R.D., 1985, The Coccinellidae (Coleoptera) of America north of Mexico: *Journal of the New York Entomological Society*, v. 93, p. 912.
- Kantrud, H.A., Millar, J.B., and van der Valk, A.G., 1989, Vegetation of wetlands of the prairie pothole region, in van der Valk, A.G. (ed.), *Northern Prairie Wetlands*, Iowa State University Press, Ames, p. 132-187.
- MacDonald, G.M., Beukens, R.P., Kieser, W.E., and Vitt, D.H., 1987, Comparative radiocarbon dating of terrestrial plant macrofossils and aquatic moss from the "ice-free corridor" of western Canada: *Geology*, v. 15, p. 837-840.
- Mayewski, P.A. and 13 others, 1994, Changes in atmospheric circulation and ocean ice cover over the North Atlantic during the last 41,000 years: *Science*, v. 263, p. 1747-1751.
- Morgan, A.V., 1989, Late Pleistocene zoogeographic shifts and new collecting records for *Helophorus arcticus* Brown (Coleoptera: Hydrophilidae) in North America: *Canadian Journal of Zoology*, v. 67, p. 1171-1179.
- Morgan, A.V., and Morgan, A., 1979, The fossil Coleoptera of the Two Creeks Forest Bed, Wisconsin: *Quaternary Research*, v. 12, p. 226-240.
- Schwert, D.P., 1992, Faunal transitions in response to an ice age: the late Wisconsinan record of Coleoptera in the north-central United States: *Coleopterists Bulletin*, v. 46(1), p. 68-94.
- Schwert, D.P., and Ashworth, A.C., 1988, Late Quaternary history of the northern beetle fauna of North America: a synthesis of fossil and distributional evidence: *Memoirs of the Entomological Society of Canada*, v. 144, p. 93-107.
- Watts, W.A., and Winter, T.C., 1966, Plant macrofossils from Kirchner Marsh, southern Minnesota—a paleoecological study: *Geological Society of America Bulletin*, v. 77, p. 1339-1360.
- Woodman, N., Schwert, D.P., Frest, T.J., and Ashworth, A.C., in press, Paleocology of subarctic faunal assemblages from the Woodfordian age (Pleistocene: Wisconsinan) Elkader site, northeastern Iowa.



0 2 4 6 Miles



**Figure 1.** Map showing the location of three transects along Indian Creek, Humboldt County, Iowa.

## **STOP 3. STRATIGRAPHY OF A LINKED-DEPRESSION SYSTEM, INDIAN CREEK, HUMBOLDT COUNTY**

Leaders: E. Arthur Bettis III, Deborah J. Quade, and Timothy J. Kemmis

### **INTRODUCTION**

At this stop we will use shallow cores taken from part of a linked-depression system as a springboard for a discussion of the origin and stratigraphy of linked-depression systems. This is part of a large linked-depression system that joins the surface drainage lines of Indian Creek basin with those of adjacent surface basins. In 1991, we undertook a study of the linked-depression system of Indian Creek basin as a cooperative project with the Natural Resources Conservation Service (NRCS). Richard Lensch, Louis Boeckmann, and Asghar Chowdhry, all with the NRCS, assisted us with the investigation.

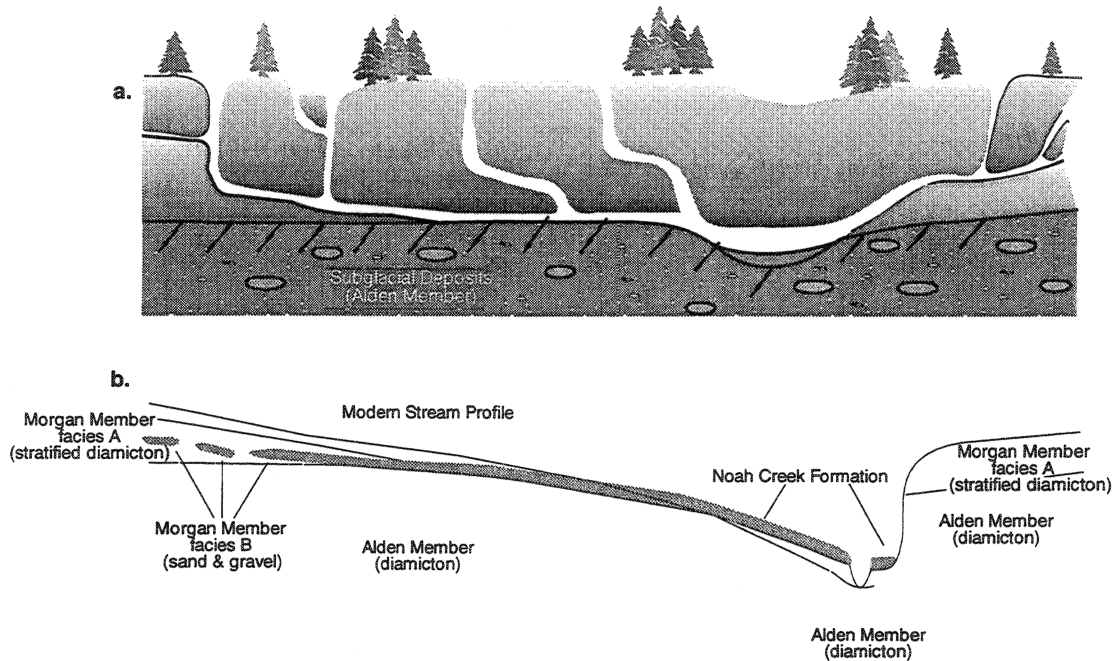
Linked-depression systems are a recently recognized glacial landscape feature of the Des Moines Lobe (Kemmis, 1991). The systems consist of a series of semi-closed depressions that have one or more "outlets" across low saddle-like areas (see Figure 16B, p.35). The saddles separate a chain of depressions that define a valley. On air photos the trends of the valleys can sometimes be discerned and usually exhibit a reticulate pattern that connects some present drainage lines with others that are now in different drainage basins. The formation of linked-depression systems is interpreted to occur in a glacial karst system developed in a debris-rich stagnant glacier (see Figure 20, p.39). As ice wastage occurs sediment is flushed out of the glacial karst passages, so that when ice wastage is complete the former glacier karst passageways become preserved as a system of branching semi-closed depressions—a linked-depression system.

The Indian Creek study involved the drilling of transects across parts of the linked-depression system. Three of the transects illustrate relationships along different reaches of linked-depression systems on the Lobe. This stop, the Davis transect, is in the upper, unchanneled reach of Indian Creek valley. The middle transect (number 3) is located about 13 km "downstream" in an artificially channeled part of Indian Creek valley, and the lower transect (number 2) is about 4 km farther down valley in the incised and meandering reach of the valley about 2 km above the junction with the Des Moines River valley (Figure 1). Air photos and field mapping show that this linked-depression system in this area joins all drainage basins between the Lizard Creek divide on the west, the Des Moines valley on the east, and the West Fork of the Des Moines River (DMR) on the north.

### **STRATIGRAPHY**

Two facies of the Morgan Mbr. are associated with linked-depression systems: 1) stratified diamicton with thin lenses and pods of sorted sediments (facies A), and 2) thicker lenses of sorted sediments, dominantly pebble sands and gravels (facies B). Facies A is resedimented diamicton and associated sorted sediment that accumulated primarily by sediment gravity flow and small-scale channeled flow as the glacier melted (supraglacial deposits). Facies B is predominantly alluvium deposited in tunnels of the glacial karst system at and near the base of the glacier. The distribution of these facies varies. Figure 2a is a cross-



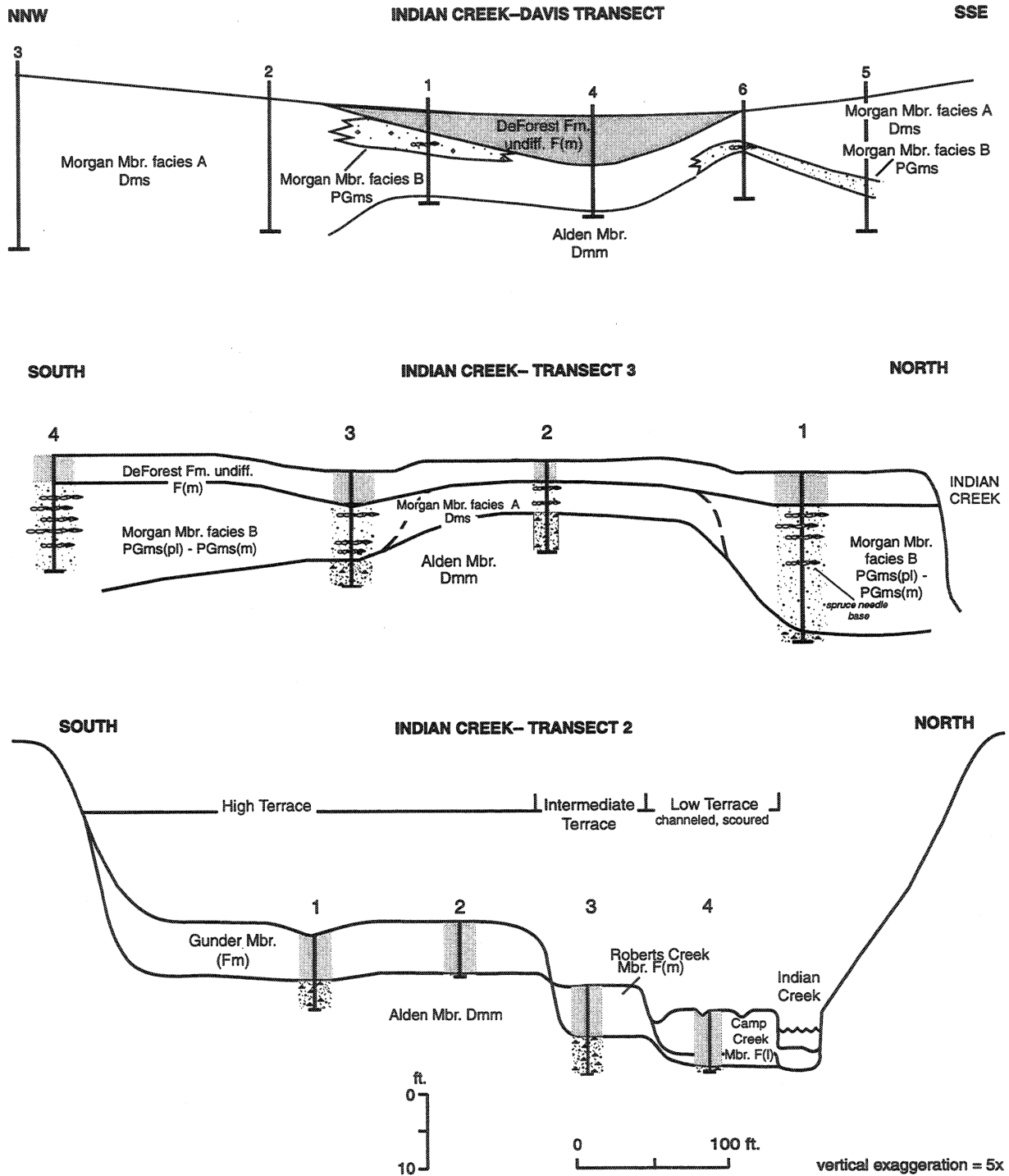


**Figure 2.** a) Illustration of a cross section through the wasting DML glacier showing numerous tunnels developed in the glacial karst system and the linkage to a central drainage tunnel. b) Idealized profile along a linked-depression system illustrating the distribution of sand and gravel within the former glacial karst system.

section through the wasting Des Moines Lobe glacier showing tunnels of the glacial karst system linked to the central drainage tunnel of the Des Moines Lobe (now the DMR). Figure 2b shows an idealized profile along the linked-depression system illustrating the distribution of sand and gravel in the former glacial karst system. In the upper reaches of the system where the tunnel was within the ice the Morgan Mbr. facies B is contained within the supraglacial deposits (Morgan Mbr. facies A). In the middle reach where the tunnel was at the base of the glacier Morgan Mbr. deposits rest on the basal till (Alden Mbr.). Farther downstream the former englacial and subglacial sorted sediments are at the land surface and included in the Noah Creek Fm.

Transects along Indian Creek were used to develop the model shown in Figure 2. In the upper reaches of the linked-depression system, (Figure 3a), tunnels were within the ice; sorted sediments associated with the karst tunnel (Morgan Mbr. facies B) are discontinuous across the depression, possibly a result of collapse during melting of underlying ice. Farther downvalley (transect 3; Figure 3b) the linked-depression system is interpreted to have been at the base of the glacier; Morgan Mbr. facies B deposits are continuous across the transect and always rest on the Alden Mbr. (subglacially deposited till). Still farther downvalley (transect 2), Holocene entrenchment of Indian Creek has removed any evidence of Morgan Mbr. deposits, and Holocene alluvium of the DeForest Fm. rests unconformably on the Alden Mbr. (Figure 3c).

The stratigraphy and sedimentology of the linked-depression systems indicate that the sand and gravels comprising facies B of the Morgan Mbr. were deposited **during** ice wastage.



**Figure 3.** Transects along Indian Creek, Humboldt County, Iowa: The Davis Transect was completed in the upper reaches of the linked system where Morgan Mbr. facies B sediments are discontinuous; Transect 2 was completed further downvalley where Morgan Mbr. facies B deposits are continuous and rest on Alden Mbr. diamicton indicating deposition at the base of the glacier; Transect 3 is from further downvalley where Holocene entrenchment has removed the Morgan Mbr. deposits and Holocene alluvium rests unconformably on Alden Mbr. sediments.

At the upper transect, part of facies B is enclosed by facies A deposits, therefore the two facies are contemporaneous in this area. Also note that the sands and gravels in this transect are not located along the "thalweg" of the modern depression. If the deposits were deposited by a post-glacial stream the sands and gravels would be present beneath the "valley" axis. A low ridge prevents surface drainage of this part of the linked-depression system from flowing downvalley, thus a through-flowing post-glacial stream seems precluded from the upper reaches of the system. Farther downvalley at transect 2, facies A and B are adjacent to each other and it could be argued that facies B cuts out (and therefore postdates) facies A in the depression areas. Two aspects of the deposits in this transect, however, argue strongly for a late-glacial rather than post-glacial age. First, the thickness and texture of the deposits suggests a large water and sediment source. The sluggish, low-gradient Holocene stream that drained this part of the valley seems incapable of forming such a thick sand and gravel deposit. At hole 1 the base of a spruce needle (identified by R.G. Baker) was recovered from a fine-grained lens 3.0 m above the base of the facies B deposit (Figure 3b). Spruce macrofossils also indicate a late-glacial age for the deposit (R.G. Baker, personal communication 1991).

## REFERENCES

- Kemmis, T.J., 1991, Glacial landforms, sedimentology, and depositional environments of the Des Moines Lobe, northern Iowa: University of Iowa, Department of Geology, Iowa City, PhD dissertation (Diss. Abstr. 91-36947).

## **STOP 4. TERRACE STRATIGRAPHY AND GEOMORPHOLOGY OF THE OKOBOJI LAKE OUTLET**

Leaders: Deborah J. Quade, Timothy J. Kemmis, and E. Arthur Bettis III

***PLEASE STAND AWAY FROM THE PIT WALLS AT THIS SITE.  
THEY ARE EXTREMELY UNSTABLE.***

### **INTRODUCTION**

Several studies have provided insight into the evolution and the development of Late Wisconsinan (LW) terraces associated with the Des Moines Lobe (DML) (Kemmis et al., 1988; Kemmis, 1991; and Quade, 1992). These studies are the basis for a regional framework for the Noah Creek Fm. showing that: 1) there is a repetitive stratigraphy associated with LW valley-train terraces; 2) river valleys can be separated into four geomorphic segments: proximal, transitional, bedrock-controlled, and distal segments, where flow regime and depositional environment varied and; 3) there are three terrace types that each possess a distinct stratigraphy: a longitudinal type, a point type, and a cut-off type.

Table 1 provides a comprehensive comparison of LW proximal and distal terraces associated with the Des Moines Lobe. Proximal and distal terrace deposits associated with the DML have consistent coarse-grained stratigraphic sequences composed of the Noah Creek Fm. which are grouped into three units; lower, middle and upper increments. The sedimentology and stratigraphy of these increments indicate that they were deposited in aggrading braided streams that carried glacial meltwater from ice-marginal sources. The terrace facies are described using a modified lithofacies code (Table 2) from codes by Miall (1977, 1978), McCabe et al., (1984), Ramos and Sopena (1983), and Eyles et al., (1983). The lithofacies code is a descriptive code—the first set of symbols represent grain-size sorting, and the second set of symbols (in parentheses) describe bedding structures.

### **OKOBOJI OUTLET CHANNEL**

Glacial drainage of the Des Moines Lobe was concentrated at several distinct outlets. The Okoboji Lake Outlet was an important drainage outlet along the northwestern edge of the Lobe (Figure 1). This outlet now drains an interconnected system of lakes and sloughs, including Lower and Upper Gar, East and West Okoboji, Little Spirit, Spirit, Center, Marble, and Hottes lakes.

The geomorphology and stratigraphy of the “Iowa Great Lakes” outlet system are similar to those of most larger valleys on the Des Moines Lobe, such as the Iowa, Skunk, and Des Moines, which also originated as meltwater drainageways. Along the Okoboji Lake Outlet, successive terraces are “benched” progressively lower into Dows Fm. diamicton. Successive terrace levels were formed during multiple periods of incision and aggradation. Noah Creek Fm. stratigraphic sequences beneath the terraces are dominated by sand and gravel deposited from bedload and suspended load; fine-grained overbank deposits occur only as an uppermost veneer. A wide variety of sediment types and structures (facies) indicate

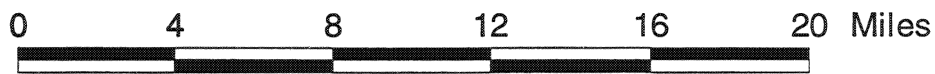
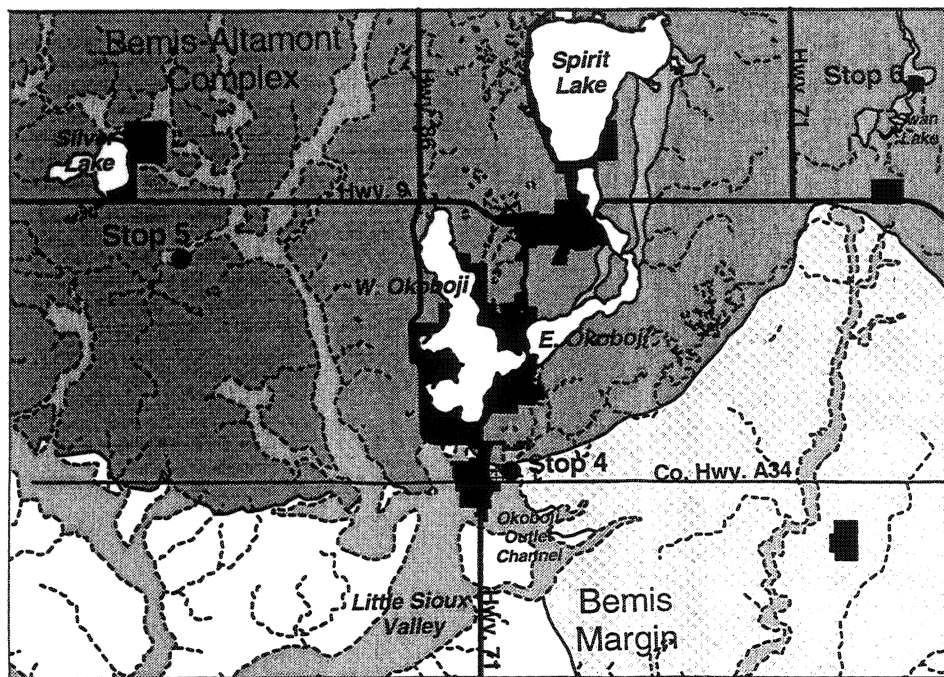
**Table 1.** Comparison of proximal and distal valley-train terrace deposits on the Des Moines Lobe, Iowa (modified from Kemmis et al., 1987).






<p><b>GENERAL ENVIRONMENTAL SETTING</b></p>	<p>The differences in valley landscapes, sedimentary structures and stratigraphic sequences between proximal and distal valley segments are related to: 1) proximity to former glacial meltwater sources (end moraines), 2) the effects of widely varying glacial discharge regimes, and 3) local bedrock control in distal reaches. Former ice-marginal positions (end moraines) were major sources of both water and sediment in the drainage basins. Glacial meltwater discharge is extremely variable seasonally. Predictable seasonal cycles were marked by winter freeze-up and low base flow followed by major floods which occurred during summer break-up. There is evidence that infrequent, high magnitude episodic glacial lake outbursts, called jokulhlaups, occurred. It is theorized that sudden drainage of supraglacial, subglacial or proglacial lakes occurred on the Des Moines Lobe. Distal areas are located downvalley of erosionally resistant Mississippian-age escarpments of carbonate rocks where stream incision rapidly cut through less resistant clastic Pennsylvanian-age bedrock.</p>	
<p><b>GEOMORPHIC SETTING</b></p>	<p><b>PROXIMAL TERRACES</b></p> <p>Adjacent to former ice-marginal sources (end moraines). These valley reaches are generally broad and shallow with low relief (&lt;3m) between terraces. Uppermost (oldest) terrace is commonly kettled.</p>	<p><b>DISTAL TERRACES</b></p> <p>Down valley from former ice-marginal sources. Distal reaches are generally deeply entrenched with multiple terraces, each separated by several meters of relief.</p>
<p><b>STRATIGRAPHY AND SEDIMENTOLOGY</b></p>	<p>The deposits occur as three successive increments separated by terrace-wide disconformities. Proximal deposits are extremely coarse-grained, predominately pebble to cobble gravel and pebbly sand. The upper increment is composed of a massive to crudely planar-bedded cobble gravel (&lt;1-2 m), truncated in places by large-scale channel fills (&gt;4 m wide) of similar grain-size. The two underlying increments are &gt;3 m thick and consist of small- to large-scale channel fills (1 to &gt;4 m wide) and solitary sets of large-scale planar and wedge crossbeds that are composed of pebbly sand and pebble gravel. Large-scale crossbeds of the lower and middle increments are of a complex geometry. Basal surfaces are irregular and upper surfaces are eroded from resulting channel incision prior to deposition of overlying sediment. Channel fills are common, where the bedding parallels channel cross section. Less commonly observed channel fills are complex, multi-storied and transverse fills (Ramos and Sopena, 1983). Channel boundaries are not marked by constructional bar deposits, but by older channel and within-channel deposits which are partially incised by later erosion.</p>	<p>The deposits occur in three distinct increments separated by disconformities. The lowermost increment consists of pebbly sand and sand in a variety of small-to-medium -scale in-channel sedimentary structures, including massive and planar crossbedded sediments. Numerous migrating bedform deposits occur such as ripple-drift cross-lamination and several types of cross stratification, as well as several types of simple channel fill types; lateral accretion bedforms occur in point type terrace deposits. The middle increment is significantly coarser, 1-2 m thick, and disconformably overlies the lower increment. In longitudinal and point type terraces, the middle increment consists of a crudely planar-bedded matrix-supported cobble gravel and appear to be imbricated gravel sheets. In meander cut-off type terraces the middle increment is dominated by coarse, medium-scale channel fill (&lt;4 m wide) filling pre-existing channels on former terrace surfaces. The upper increment is a thin veneer of a massive sand to loamy sand that fines upward and is observed on all terrace surfaces.</p>
<p><b>INTERPRETATION OF DEPOSITIONAL ENVIRONMENT</b></p>	<p>The preservation of a stacked sequence of channel fills and large-scale migrating bedforms suggests rapid aggradation in a braided stream environment. The disconformable sequence of lower and middle increments suggests that the terrace sequence was not deposited continuously, but that there were various episodes of sedimentation probably related to annual (seasonal) or, more likely, longer term variations in meltwater discharge. The crudely-bedded cobble gravel associated with the upper increment may represent deposition from a high magnitude flood event such as a glacial lake outburst (jokulhlaup) and numerous large-scale channel fills of similar grain-size may represent more frequent, lower magnitude flood events with hyper-concentrated flows .</p>	<p>The lower increment represents in-channel deposition of various types of bedforms dependent on local flow conditions and water discharge variations through time. The middle increment represents deposition from a high-magnitude flood (jokulhlaup). The thin, fine-grained upper increment appears to represent the final preserved, depositional record of such a flood that deposited the middle and upper increments. This flood event resulted in the stream downcutting to a new floodplain level; following steam incision, the cycle of glaciofluvial sedimentation outlined above was again repeated.</p>

**Table 2.** Lithofacies code for fluvial and glaciofluvial deposits (from Kemmis et al., 1988<sup>1</sup>).

<b>GROSS PARTICLE SIZE - first symbols</b>		
BG <sup>2</sup>	boulder gravel	ms <sup>5</sup> clast-supported
CG <sup>2</sup>	cobble gravel	ms <sup>5</sup> matrix-supported
PG <sup>2</sup>	pebble gravel	cm <sup>5</sup> clast-to-matrix supported
S <sup>3</sup>	sand	
F <sup>4</sup>	finer	
<b>BEDDING STRUCTURES<sup>6</sup> - second symbols, in parentheses</b>		
(m)	massive.	
(pl) <sup>7</sup>	plane-bedded; crudely horizontal; may be slightly undulatory.	
(h) <sup>7</sup>	horizontally laminated; may be slightly undulatory.	
(r)	ripple-drift cross-laminated (various types).	
(t)	trough cross-bedded; size (scale) and single or multiple sets noted on log.	
(w) <sup>8</sup>	wedge cross-bedded; size (scale) and single or multiple sets noted on log.	
(p) <sup>8</sup>	planar cross-bedded; size (scale) and single or multiple sets noted on log.	
(c) <sup>9</sup>	cross-bedded deposits with complex upper and lower contacts; generally large-scale, solitary sets; lower contacts commonly undulatory over irregular channel floor; upper contacts commonly undulatory, truncated by overlying bedding structures.	
(la) <sup>10</sup>	lateral-accretion deposits.	
(ccf) <sup>11</sup>	channel cut-and-fill; massive or simple structures mimicking the scoured channel cross-section.	
(ccfc)	channel cut-and-fill structure with complex facies changes within the fill (see Ramos and Sopena, 1983).	
(ccft)	channel cut-and-fill structure with transverse fill (see Ramos and Sopena, 1983).	
(ccfms)	channel cut-and-fill structure with multi-storey fill (see Ramos and Sopena, 1983).	
(lag)	lag at base of channel or cross-bed set.	
(g)	normally graded.	
(ig)	inversely graded.	
(n-i)	low angle (<10°) crossbeds.	
(e)	erosional scours with intraclasts.	
(s)	broad shallow scours.	
(sc)	laminated to massive fines.	

- 1 This is a descriptive code, interpretations not made here. Modified to greater or lesser extents from Miall (1977), Eyles et al. (1983), McCabe et al. (1984), Ramos and Sopena (1983), and the authors' own work. Further additions probable. Lithofacies for diamictons are given in Eyles et al. (1983); not listed here. Deformation structures are described separately in detail.
- 2 Mnemonic; first letter denotes largest particle sizes present: boulder, cobble, or pebble.
- 3 Upper particle-size limit is 2 mm; as used here, "sand" is material which has <30% silt and clay matrix.
- 4 This category includes a variety of sand-silt-clay mixtures; we further break down this category with U.S.D.A. textural classifications (Soil Survey Staff, 1975) in the descriptions; e.g., loam, silt loam, silty clay loam, etc.
- 5 In gravelly deposits, particle-size grading becomes apparent and has hydrodynamic significance; hence, subdivision as cs,ms, or cm.
- 6 Certain structures, such as ripple-drift cross-lamination, are generally restricted only to certain particle sizes.
- 7 The distinction between plane-bedded and horizontally laminated is made on the basis of bed thickness and difference in the particle sizes involved.
- 8 Differentiation as wedge or planar sets appears to be based on scale; planar sets have greater width to height ratios. Planar sets are also referred to by some authors as tabular crossbeds.
- 9 Somewhat similar to gamma cross-stratification of Allen (1963).
- 10 In some instances, various lithofacies may occur as sets in this geometry. In such a case, this designation becomes a third symbol; e.g., S(r)(la).
- 11 Occurs on a larger scale than trough cross-bedding.



-  Bemis-Altamont Complex
-  Bemis Margin
-  Alluvium
-  Incorporated Towns
-  Stop Site



**Figure 1.** Map of the Des Moines Lobe showing former ice marginal positions and the extent of outwash associated with the Okoboji Lake Outlet .

significant stream-flow fluctuation as each terrace fill aggraded. Despite the wide variety of facies, each terrace fill is composed of three distinctly different stratigraphic increments; lower, middle and upper. The distribution of these three increments is illustrated in Figure 2 and is a west to east cross section of the Milford Cemstone Pit.

### **Lower Increment**

The lower increment is the thickest of the three increments, and has the widest variety of sedimentary structures, consisting of various complex cross-bed types, dominantly medium-scale complex cross beds composed of sand [S(c)] and matrix-supported pebble gravel [PGms(c)]. The upper and lower contacts are complex; the upper and lower boundaries are undulatory and appear to mimic former channel floors. Grain size is variable ranging from medium to coarse sand, to matrix-supported pebble gravel. Occasionally, pebble gravels occur at the lower bounding surface of the larger scale crossbeds or as bedded stringers in the unit (Figure 3). At the Okoboji Lake Outlet, the sedimentary structures are mostly different cross-bed types deposited by dune migration across the former outwash channel floor.

### **Middle Increment**

The middle increment is typically 1.5 to 2.5 m thick and consists of a massive clast-to-matrix supported cobble gravel to pebble gravel (CGcm-PGcm (m)). This increment unconformably overlies the lower increment; this contact is marked by a cobble line (Figure 4). At this site, the middle increment is dominated by massive-to plane-bedded cobble gravel. The poor sorting in these gravels indicates a stream with high sediment supply and the simultaneous deposition of both bedload and suspended load. This massive gravel is truncated, in places by various-scale, low amplitude channel fills, composed of clast-to-matrix supported pebble gravel (PGcm(ccf)) (Figure 5). The numerous fills may be indicative of a complex depositional environment, as would be expected in a braided stream environment with numerous diverging and anastomosing channels. At any given terrace level, there is downstream fining, particularly of middle-increment deposits. For instance, the modal clast diameter in the middle increment at the Okoboji Lake Outlet is approximately 20-30 cm; and approximately two miles downstream it is 7-10 cm. In this outlet channel, the modal clast diameters of the middle increment in the lowest, youngest LW terrace are smaller than those in the older, higher terraces.

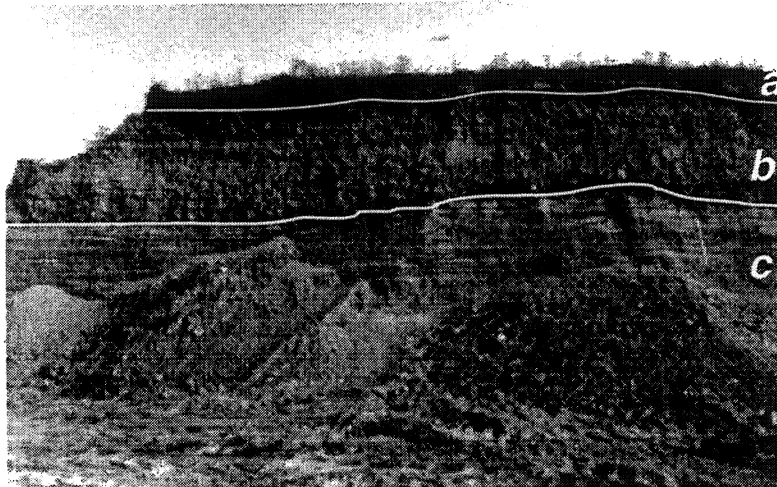
### **Upper Increment**

The upper increment consists of a thin veneer of fine-grained sandy loam to loam overbank sediment. In the Okoboji outlet system, this increment is typically 0.3 to 0.7 m thick (Figure 5) and consists of massive upward-fining sandy loam to loam.

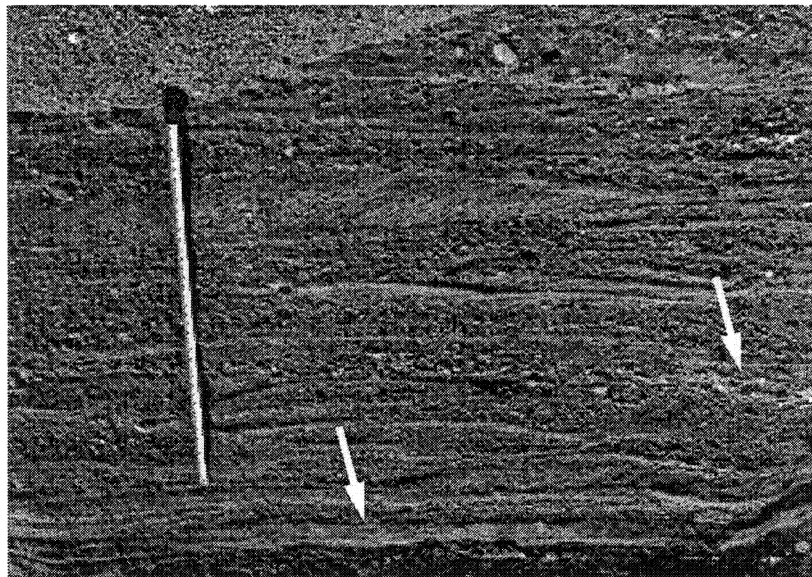
## **CONCLUSION**

Lakes are commonly regarded as sediment "traps," allowing only the finest sediment to escape over the spillway in suspension. Obviously, there were no lakes present in the Okoboji

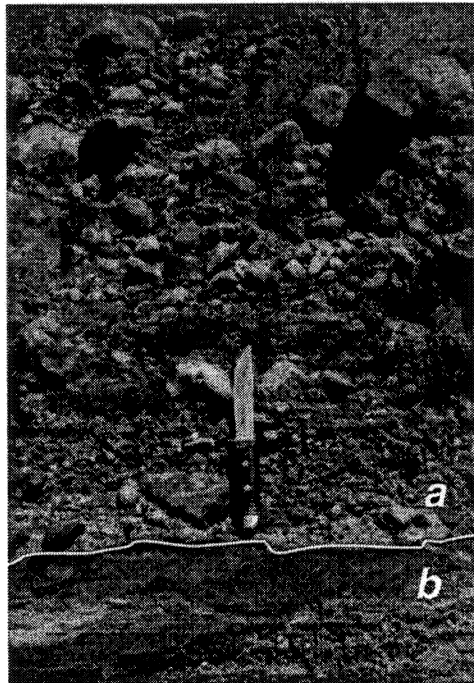




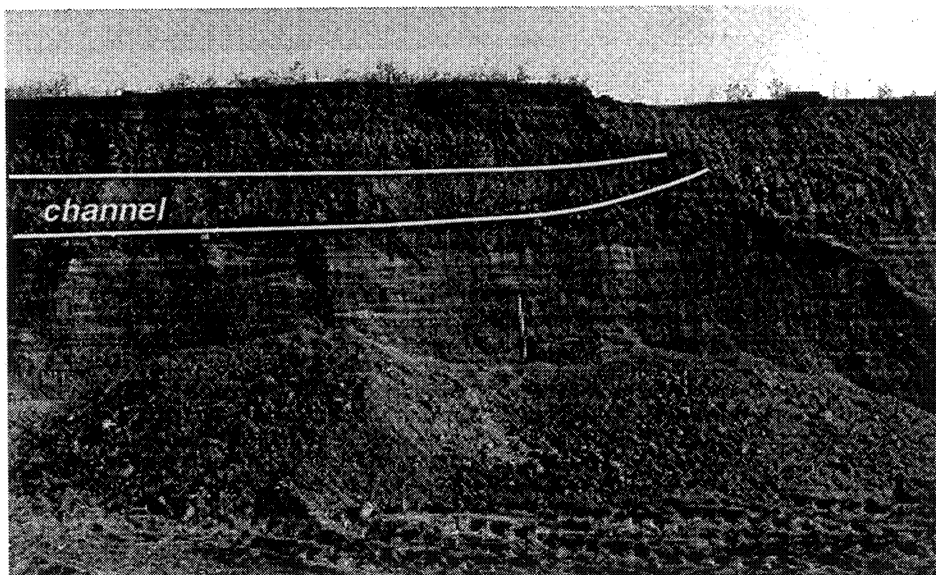
**Figure 2.** Photo of the Kruse-Milford Pit section showing sedimentary types and structures associated with the various increments of the Noah Creek Fm.: a) upper; b) middle; and c) lower increments. Cross section runs from west to east; meter stick for scale.



**Figure 3.** Photo of lower increment medium-scale complex cross-bed types that were deposited by dune migration across the channel floor. Note complex undulatory upper and lower contacts and grain-size variability of this unit (arrows); meter stick for scale.



**Figure 4.** Photo of the contact between the lower and middle increments showing the unconformity and grain size difference at the boundary. This contact is marked by a cobble gravel lag (a) associated with the middle increment that overlies lower increment coarse sand and silt beds (b).



**Figure 5.** Photo of the middle increment massive- to plane-bedded cobble gravel. In places, this massive unit is truncated by low-amplitude channel fills consisting of pebble gravel.

system when the very coarse, poorly sorted sediment of the Okoboji Lake Outlet system was deposited. The stratigraphic sequences of terraces in the Okoboji Lake Outlet are typical of glacial outwash streams associated with the Des Moines Lobe. The coarse sand-and-gravel sequence indicates high input of sediment from a glacial source, and the wide variety of sedimentary structures reflects the highly varying discharge characteristic of glacial meltwater streams.

The multiple terraces, each with a coarse middle increment near the top, also provide clues about terrace development and valley evolution on the DML (Kemmis et al., 1988, Quade, 1992). Middle increment deposits are significantly coarser, and overlie an abrupt unconformity on the lower-increment sediments. Middle increment deposits are dominated by two facies: very poorly sorted, massive to crudely planar-bedded cobble gravels and coarse-grained, low-amplitude channel fills. Middle increment deposits show a significant change of scale from the meso- and micro-forms of the lower increment to large-scale, terrace-wide (valley-wide?) deposition. The very poorly sorted cobble gravels of this increment indicate a stream with a very high sediment load, and simultaneous deposition of bed and suspended load (Harms et al., 1975). On the continuum of flow conditions and processes, middle-increment deposits probably represent very concentrated fluid-flow conditions approaching those of hyper-concentrated flow.

Thin fine-grained deposits (sandy loam to loam) comprise the upper increment. These deposits abruptly overlie middle-increment deposits, and tend to be either normally graded (fining upward) or massive. They mantle the middle increment surface filling in broad, shallow channels. These deposits are interpreted as waning flow and/or overbank deposits associated with middle-increment floods. The middle and upper increments of each terrace, then, are related to infrequent, very high magnitude glacial meltwater floods.

The infrequent, very high magnitude floods responsible for the middle and upper increments of LW terraces of the DML may be "glacier bursts" or "jokulhlaups," similar to those described by Church and Gilbert (1975), Haeberli (1983), and Sturm et al. (1987), among others. Some glacial flood events have complex hydrographs (e.g., Sturm et al., 1987), which might explain stratigraphic sequences, where the middle increment deposits appear to result from two successive flood peaks. It is unlikely that we will ever know for certain what caused these jokulhlaups in major river basins associated with the DML since the ice is long since gone, and the discontinuous terrace record downstream prohibits any full historical reconstruction. There are, however, several possibilities, including catastrophic drainage of supraglacial, subglacial, or proglacial lakes, or perhaps even seasons of extremely high melt rates.

Many jokulhlaups result from glacial lake drainage. These glacial lakes may occur in a variety of situations. Typically, modern glaciers are in mountainous areas where glacier ice dams side valleys forming lakes which subsequently drain catastrophically when a tunnel system develops in the ice. Naturally, this type of setting wasn't possible for the Des Moines Lobe. However, supraglacial ice-walled lakes (Clayton, 1967; Parizek, 1969) did occur on the DML (Kemmis et al., 1981, 1991; Graeff, 1986) and could have drained catastrophically.

Geomorphic and stratigraphic evidence, as well as radiocarbon dates, suggest that advances of the DML were rapid, followed by general stagnation of large areas of the lobe (Kemmis, 1991). This kind of glacial behavior is similar to that of surge-type glaciers which release large volumes of meltwater just prior to and in the early stages of surging. It is thus possible that some glacial floods may be related to such meltwater releases as the Des Moines Lobe surged to the Algona Moraine.

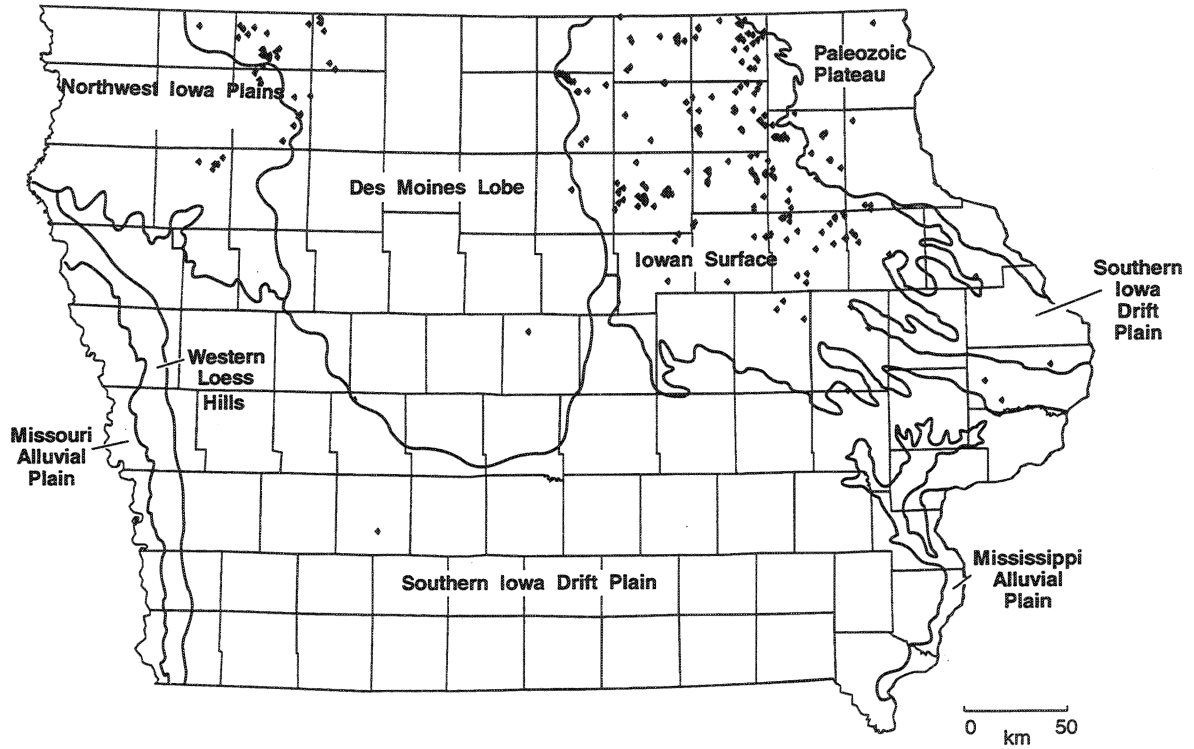
Finally, perhaps a season of unusual weather conditions, such as an uncommonly warm spring break-up period followed by widespread, high-magnitude rainstorm events, could have promoted unexpectedly high-magnitude summer flood events. Rapid drainage of meltwater from the stagnant glacier would have been promoted by the presence of a glacial karst system.

Our interpretation is that these infrequent flood events are the key to understanding the history of meltwater streams of the DML (Kemmis et al., 1985, 1987; Kemmis, 1991; and Quade, 1987, 1992). We hypothesize that besides the deposition of the middle and upper increments of the terrace sequence, these floods also caused downcutting to what later became another terrace level. The middle increment is interpreted to have been abruptly deposited on the steep rising limb of a glacial flood event where sediment discharge peaks before that of the meltwater. As the sediment load declined, meltwater discharge peaked and erosion resulted, causing valley widening, lateral downcutting, and abandonment of the former valley floor to become a terrace (bench). After the high-magnitude flood event, deposition on the new, lower valley floor was controlled by normal seasonal and diurnal fluctuations in meltwater and sediment discharge, resulting in the deposition of new lower-increment deposits on the new floodplain. With the next major flood event, new middle and upper increments are deposited before downcutting to a still lower level, and so on.



## REFERENCES

- Allen, J.R.L., 1963, The classification of cross-stratified units, with notes on their origin: *Sedimentology*, v. 2, p. 93-114.
- Church, M. and Gilbert, R., 1975, Proglacial fluvial and lacustrine environments, in Jopling, A.V., and MacDonald, B.C., eds., *Glaciofluvial and glaciolacustrine sedimentation: Society of Economic Paleontologists and Mineralogists Special Publication 23*, p. 22-100.
- Clayton, L., 1967, Stagnant-glacier features of the Missouri Coteau, in Clayton, L., and Freers, T.F., eds., *Glacial Geology of the Missouri Coteau and adjacent areas: North Dakota Geological Survey Miscellaneous Series 30*, p. 25-46.
- Eyles, N., Eyles, C.H., and Miall, A.D., 1983, Lithofacies types and vertical profile models: an alternative approach to description and environmental interpretation of glacial diamict and diamictite sequences: *Sedimentology*, v. 30, p. 393-410.
- Graeff, R. W., 1986, Glaciolacustrine sedimentation in southeastern Winnebago County, Iowa: Iowa City, University of Iowa Department of Geology, unpublished M.S. thesis, 208 p.
- Haerberli, W., 1983, Frequency and characteristics of glacier floods in the Swiss Alps: *Annals of Glaciology*, v. 4, p. 85-90.
- Harms, J.C., Southard, J.B., Spearing, D.R., and Walker, R.G., 1975, Depositional environments as interpreted from primary sedimentary structures and stratification sequences: *Society of Economic Paleontologists and Mineralogists Short Course No. 2 Lecture Notes*, 161 p.
- Kemmis, T.J., Quade, D.J., and Bettis, E.A., III, 1985, Stratigraphy and sedimentology of distal late Wisconsinan valley train terraces in north-central Iowa: *Geological Society of America Abstracts with Programs*, v. 17, no.5, p. 295.
- Kemmis, T.J., Hallberg, G.R., and Lutenecker, A.J., 1981, Depositional environments of glacial sediments and landforms on the Des Moines Lobe, Iowa: *Iowa Geological Survey Guidebook No. 6*, Iowa City, 132 p.
- Kemmis, T.J., 1991, Glacial landforms, sedimentology and depositional environments of the Des Moines Lobe, northern Iowa: Iowa City, University of Iowa Department of Geology, unpublished Ph.D. thesis, 393 p.
- Kemmis, T.J., Bettis, E.A., III, and Quade, D.J., 1987, Sedimentary sequences of Wisconsinan-age outwash streams on the Des Moines Lobe in north-central Iowa: *Iowa Academy of Science Program Abstracts, 99th Annual Meeting*, abstract no. 153.
- Kemmis, T.J., Quade, D.J., and Bettis, E.A., III, 1988, Hallett gravel pits: *Geological Society of Iowa Guidebook 48, Part 2*, p. 37-71.
- McCabe, A.M., Dardis, G.F., and Hanvey, P.M., 1984, Sedimentology of a Late Pleistocene submarine-moraine complex, County Down, Northern Ireland: *Journal of Sedimentary Petrology*, v. 54, p. 716-730.
- Miall, A.D., 1977, A review of the braided-river depositional environment: *Earth Science Reviews*, v. 13, p. 1-62.
- Miall, A.D., 1978, Architectural-elements analysis: a new method of facies analysis applied to fluvial deposits: *Earth Science Reviews*, v. 22, p. 261-308.
- Parizek, R.R., 1969, Glacial ice-contact rings and ridges, in Schumm, S.A., and Bradley, W.C., eds., *United States Contributions to Quaternary Research: Geological Society of America Special Paper 123*, p. 49-102.
- Quade, D.J., 1987, Lithofacies sequences of valley-train terraces along the Iowa River in north-central Iowa: *Geological Society of America Abstracts with Programs*, v. 19, no. 4, p. 239.
- Quade, D.J., 1992, Geomorphology, sedimentology and stratigraphy of Late Wisconsinan valley-train terraces along the Iowa River in north-central, Iowa, Unpublished Master's Thesis, University of Iowa, 85 p.
- Ramos, A., and Sopena, A., 1983, Gravel bars in low-sinuosity streams (Permian and Triassic, central Spain): *International Association of Sedimentologists Special Publication 6*, p. 301-312.
- Soil Survey Staff, 1975, *Soil Taxonomy*: U.S. Department of Agriculture, Soil Conservation Service, Agriculture Handbook No. 436, U.S. Government Printing Office, Washington D.C., 754 p.
- Sturm, M., Beget, J., and Benson, C., 1987, Observations of jokulhlaups from ice-dammed Strandline Lake, Alaska: implications for paleohydrology, in Mayer, L. and Nash, D., eds., *Catastrophic Flooding: The Binghamton Symposia in Geomorphology: International Series*, no. 18, p. 79-94.



**Figure 1.** Distribution of extant fens in Iowa (from Preserves and Ecological Services Bureau database).

## STOP 5. EXCELSIOR FEN COMPLEX

Leader: Carol A. Thompson

### INTRODUCTION

At this stop, we will be examining one of the more unusual wetlands found in Iowa—fens. In Iowa, fens are wetlands with organic soils that receive water primarily from groundwater and in general are dominated by herbaceous plants. In size, they range from <1 to 25 acres, with most less than 2 acres. Some occur as complexes, i.e., groups of individual fens clustered within one small area. They occur primarily in upland landscape positions, however at least a few are found in abandoned meander channels in the lowland. Most are on sideslopes and gradients on the fen surfaces range from 0.004 to 0.243, with 90% less than 0.1. Because most Iowa fens occur in an erosional setting, they are unlikely to be preserved in the geologic record. Only those in lowland positions have significant preservation potential.

The Preserves and Ecological Services Bureau of the Iowa Department of Natural Resources (PESB) conducted a state-wide survey of fens, locating over 300 sites in 27 counties (Pearson and Leoschke, 1992). These sites have been ranked based primarily on vascular plant assemblages and in particular the presence of rare species. Of these sites, 11 are ranked as very high quality, 18 as high quality, and 34 as medium quality. Unfortunately, several of these sites have been altered, damaged, or destroyed in the past few years. Only seven sites are in public ownership. Figure 1 shows the distribution of extant sites in Iowa from a database maintained by the PESB.

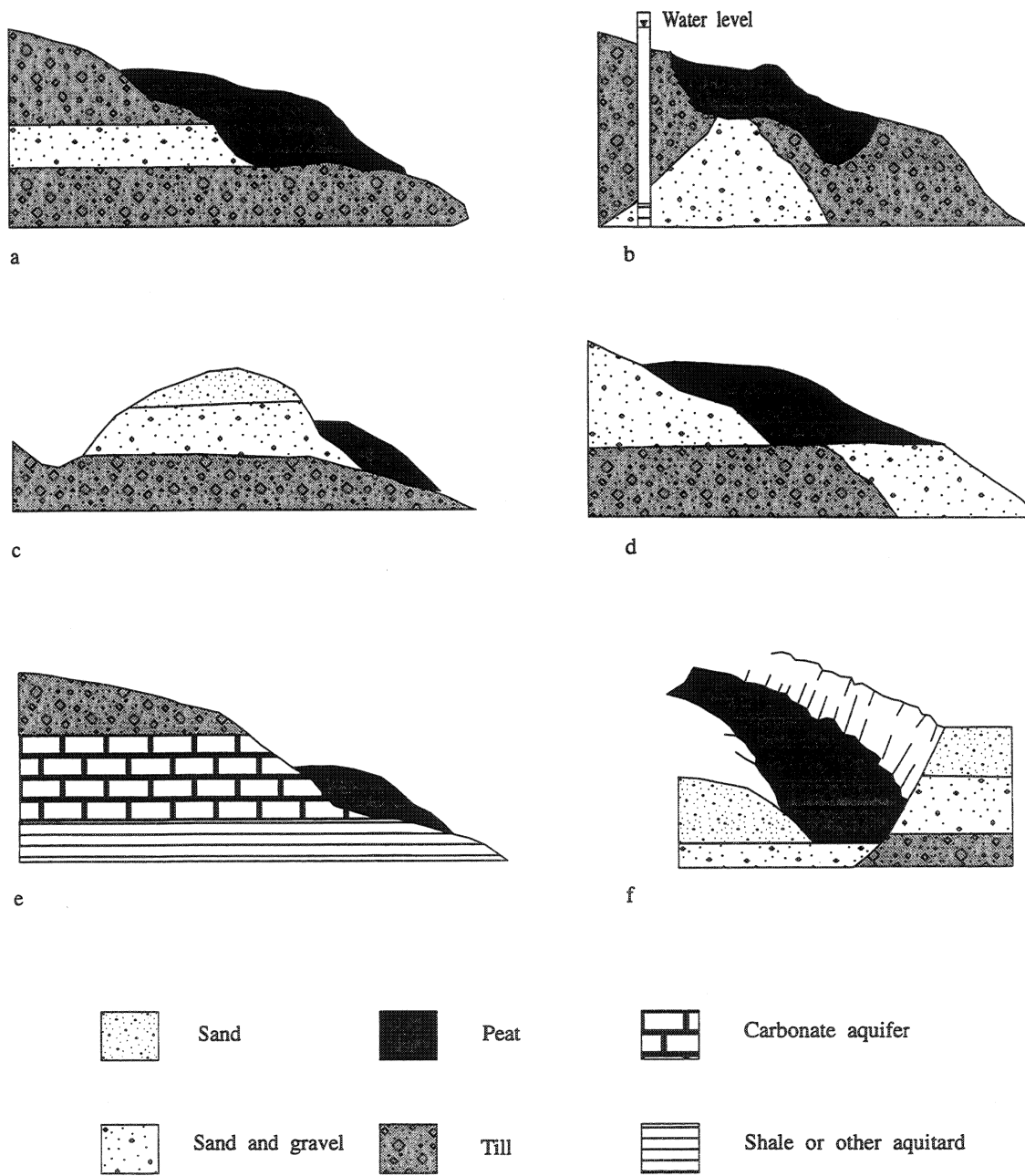
### DISTRIBUTION AND GEOLOGY OF IOWA FENS

Fens are present in all of Iowa's landform regions, though are most common in the Iowan Surface and the Des Moines Lobe (DML). Along the DML, fens are found in areas of hummocky topography associated with lateral ice margins of the DML. The host glacial deposits have undergone slight to moderate weathering during the last 12,000 years. Net effects of these changes are oxidation of the deposits to variable, but generally shallow depths, the development of a network of vertical fractures (joints) that usually do not extend deeper than the zone of oxidation, and slight leaching of primary carbonate minerals from the upper foot. The joint system of DML deposits is not as well-developed as in Pre-Illinoian deposits and, although still providing an avenue for groundwater recharge, often does not permit as rapid a response in the water table position.

Thompson and others (1992) have separated Iowa fens into six categories on the basis of landscape position, and the stratigraphy and hydrology of the water-bearing deposit that recharges the fen. The six categories proposed for Iowa fens are: 1) fens developed along valley walls where sand and gravel between glacial tills (inter-till) is exposed; 2) fens in hummocky topography on the margins of the DML that are recharged by sand and gravel buried within glacial till (intra-till), and which exhibit artesian flow; 3) those located on the lower slopes of ridges of exhumed sand and gravel on the Iowan Surface; 4) fens at the base of benched alluvial terraces or glacial outwash deposits; 5) fens recharged by bedrock aquifers; and 6) fens occupying abandoned channel areas (Figure 2).

The Excelsior Fen Complex we will visit is a Type 2 and occurs in an area of hummocky





**Figure 2.** Schematic diagram showing geologic settings of Iowa fens: a) inter-till, b) artesian, c) gravel ridge, d) terrace, e) bedrock, and f) abandoned channel.

topography along the western margins of the DML. The geometry of the water-bearing deposits is poorly understood for this type of fen. The sand and gravel is apparently contained within DML glacial deposits and is therefore referred to as "intra-till." Heads in the sand and gravel are above the surface of the peat indicating confined or artesian conditions. The sand and gravel is often overlain by low-permeability deposits and upward flow into the peat occurs at a breach in this confining layer. The recharge area and the extent of the sand and gravel deposits are usually unknown.

Surface features on fens are variable. The surface is often wet, but with little standing water. Compression of the peat by walking on it can lead to development of small shallow pools. Only a few fens have well-developed pool areas formed by natural mechanisms and, where present, biogenic carbonate can be abundant, coating the plant remains. During drier years, the surface will be dry, although the peat itself is usually damp. In most cases, the water table drops less than a foot below ground surface. Discharge zones are often recognized by red flocs and "oil" films. They are created as anoxic groundwater discharges from iron-rich sediments. Tufa, or biogenic carbonate, can be present, sometimes forming lenses in the peat body. At some sites the biogenic carbonate is dispersed throughout, altering the color of cores. Some fens, particularly with artesian water sources, have springs surrounded by well-developed mound areas. These areas are underlain by fluidized peat, carbonate muck, and/or sand, and are not particularly solid surfaces. Other areas of the fen where discharge is occurring are buoyant, but can be walked on.

## PEAT

Peat can be defined as a soil formed under saturated, anaerobic conditions, with an organic content of at least 20 percent and an ash content of less than 50 percent (Crum, 1988). The peat in Iowa fens is normally a well-humified, sapric variety, although considerable variation occurs. It is not unusual for cores from the same fen to have layers of fibric peat, interbedded with carbonate hash, tufa, or sapric muck. Such interbedding would appear to imply changes in hydrologic regime and/or allogenic factors at varying times. On the Von Post scale of humification, Iowa peat ranges from H6 to H10. Ash content measured at three sites ranges from 18 to 85%; most is less than 50%. The larger values were obtained from a site dominated by carbonate-rich muck and carbonate hash. Ash content varies not only with depth, but also with position in the fen. Based on visual examination, the peat has higher ash contents in the hummock areas and less in the sedge-mat zones. In fens with no vegetative zoning, there is usually an area near the middle of the fen with lower ash contents that is probably related to upwelling flows within the fen. These areas with more or less constant water flow and subsequently high, stable water levels have less decomposition and develop less-humified peats than areas where flow and water levels are more variable.

Peat thickness is also variable. Peat thicknesses of less than four feet are common over much of a fen area with smaller areas of thicker peat. Maximum peat thickness cored in any Iowa fen has been 15 feet. Areas of maximum peat thickness do not necessarily coincide with surface features on the fen, but can be correlated with the position of a sedge mat if one is present. Areas of thickest peat are usually coincident with subsurface depressions or slope inflections.

## VEGETATION

Over 225 vascular plants have been noted on Iowa fens. *Carex stricta* (tussock sedge) and

*Eupatorium maculatum* (joe-pye-weed) were the most commonly encountered graminoid and forb species; *Carex stricta* is typically dominant. Other commonly encountered (>50% presence) herbaceous species were *Scirpus acutus* (hardstem bulrush), *Calamagrostis canadensis* (Canada bluejoint grass), *Pycnanthemum virginianum* (common mountain mint), *Aster puniceus* (red stem aster), *Aster umbellatus* (aster), *Eupatorium perfoliatum* (Boneset), *Helianthus grosseserratus* (sawtooth sunflower), *Asclepias incarnata* (marsh milkweed), *Lobelia siphilitica* (great blue lobelia), *Pedicularis lanceolata* (lousewort), *Viola nephrophylla* (violet), and *Helenium autumnale* (sneezeweed). *Solidago* spp. (goldenrod) commonly occurred on disturbed sites. Pearson and Leoschke (1992; Table 3) gives a more complete list.

The dominance of *Carex stricta* often differentiates Iowa fens from other Midwestern fens. In Wisconsin, Curtis (1959) identifies *Calamagrostis canadensis*, *Spartina pectinata* (slough grass), *Bromus ciliatus* (hairy brome), and *Andropogon gerardii* (big bluestem) as the most prevalent graminoids in fens; *Carex stricta* was important only in the southern sedge meadow community. Carpenter (1990) determined that *Carex stricta* was dominant in fens with fluctuating water tables which also corresponds to its position in Iowa fens. *Andropogon gerardii* and *Schizachyrium scoparium* (little bluestem) were identified as dominants in most northern Illinois fens (Moran, 1981). *Andropogon gerardii*, *Spartina pectinata*, and *Sorghastrum nutans* (indian grass) were dominant in Missouri sites, although some Missouri fens are dominated by *Carex stricta* as well (Nelson, 1985; Orzell and Kurz, 1986).

Some fens show well-developed vegetative zoning with an outer area dominated by *Carex stricta* (hummock grass) and an inner area, referred to as a sedge-mat or lawn, dominated by *Rhynchospora capillacea* (capillary beak rush) and *Scleria verticillata* (low nut rush). Zonation is weakly developed or absent in eastern Iowa fens, while relatively common in western Iowa fens and may be controlled by hydrologic characteristics. Hummocks are common on most Iowa fens. These are small structures, less than 1 foot across, about 1/2 to 1 foot tall although they can be as tall as 2 feet, and often are about 1/2 to 1 foot apart. They are usually well-expressed around the edges of the fens where cattle have accentuated these structures.

## AGE AND DEVELOPMENT OF IOWA FENS

Basal radiocarbon ages from Iowa fens range from 1,240 to 10,900 B.P. The dates show that initiation of the latest period of peat development in Iowa was not synchronous, but rather controlled by landscape evolution and resultant hydrology at each site. However, regional climate change may have been an important factor. Of the 19 fens, 13 have basal ages younger than 5,000 B.P. The mid-Holocene in Iowa was warmer and drier than at present, except for extreme eastern Iowa where a sharp climatic gradient appeared to be present and mesic forest persisted until about 5,500 B.P. (Chumbley et al., 1990). Pollen cores from several sites put the period of maximum dryness in central and western Iowa somewhere between 6300 and 5000 B.P. (Baker et al., 1990; Van Zant, 1979; Van Zant and Hallberg, 1976) which would appear to have been the case for most of the studied fens. Lake levels were frequently lower and shallow groundwater levels would have been lower, so conditions may not have been favorable for peat accumulation. Another possibility is that peat had developed previously at the sites, but during this dry period was degraded, burned, and/or eroded. Older dates may imply that local hydrologic conditions were sufficient to overcome regional drought conditions. It is also possible that these older fens may have

hiatus' in peat accumulation which have not been documented. Such a hiatus occurs at Sumner Bog (Van Zant and Hallberg, 1976) and Postville fen in eastern Iowa (R.G. Baker, personal communication).

## HYDROLOGY

Measurements of water levels in Iowa fens between 1989 and 1992 give a general indication of the flow regimes and gradients. Flow is upward from the sand and gravel into the peat. An upward gradient also exists at the upper end of the fen even where the sand and gravel is overlain by a thin loam or till layer (Figure 3). Flow in the peat is primarily lateral, although in some areas there are vertical gradients within the peat. Downward flow gradients in the peat are often found at the outer edges of the site, particularly where the peat is isolated from the sand and gravel by a loam or thin till. This will lead to an apparent mixing zone in the fen where water from the sand and gravel interacts with rainwater from above. Horizontal gradients in the peat closely mimic surface topography and show no obvious changes with depth. Vertical gradients are high between the sand and gravel and the peat, but fairly low within the peat. Vertical gradients are stronger in fens with higher conductivities and may also relate to aquifer characteristics.

Water levels appear to be stable in the fens over time. This is thought to result from a combination of factors: the stability of the water source, the position of the fen on the landscape, and the nature of the peat materials. Peat, having a high water capacity, will retain much of the water in dry times, where during wetter periods excess water will be available to run off. This characteristic will tend to dampen water level variability except during extreme climatic events. The position of the fen is also important. Most hillside fens are bounded by streams on their lower edges which presumably act as boundaries for the local flow system and control water levels in the immediate vicinity.

Hydraulic conductivities are low, which is to be expected in sapric, peaty materials. Measured conductivities ranged from  $1.2 \times 10^{-4}$  to  $8.6 \times 10^{-7}$  cm/sec and correlate with peat texture. Hydraulic conductivities exhibited spatial variation, being higher in the middle and/or sedge mat areas than at fen edges, again attributable to textural differences.

## WATER CHEMISTRY

The water chemistry work has shown interesting results. Western fen sites appear to be different than eastern sites. Concentrations of most common ions are higher in western Iowa than in eastern Iowa, while the reverse is true for nitrate concentrations (Table 1). These differences can be explained by reference to the weathering characteristics of the surrounding geological materials, which control recharge rate, and the lithologies of the various units. In addition, the regional climatic gradient can lead to accumulation of soluble salts in some western fens. Many of these water chemistry differences can also be related to the geological fen-classification system. Fens where sand and gravel is at the surface such as outwash, alluvial, or gravel ridge settings are more susceptible to surface-derived alteration of their water chemistry. Fens in which the recharge water must first filter through a till sequence would seem to be less susceptible, but there are still differences between eastern and western sites. Variation in weathering profiles and secondary fracture patterns may provide an explanation for these water chemistry differences. The highly weathered, jointed materials around the eastern sites promote rapid flow-through of water to the sand and gravel. In many

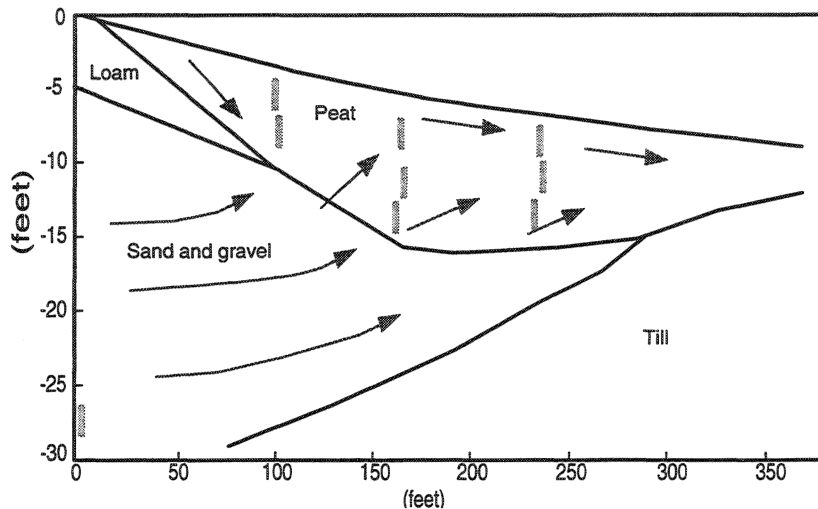


Figure 3. Schematic of flow in a typical Iowa fen.

cases, the water table is within the sand and gravel. Seasonal fluctuations will affect the supply of water; in addition, precipitation effects are rapidly transferred to the aquifer. Less fracturing and shallower weathering profiles around western intra-till and inter-till sites results in slower infiltration rates. Denitrification in western tills also occurs and can reduce the nitrate loads delivered to fen sites.

Groundwater flowing from the sand and gravel into the peat undergoes significant changes in chemical composition which are controlled by a series of bacterially-controlled precipitation, oxidation, and reduction reactions. In particular, sulfate and nitrate-nitrogen showed decreases in concentration as groundwater flowed from the sand and gravel to the peat, while pH and alkalinity increased in the peat. These decreases are attributable to sulfate reduction and denitrification reactions. The precipitation of marl/tufa also occurs and can be accompanied by co-precipitation of inorganic and organic iron, phosphorus, and manganese compounds. Not all analytes showed changes. Magnesium and sodium showed no systematic changes and conductivity changes were site-specific.

One question which has been asked is whether the vegetation could be differentiated among fens based on water quality. Previous water quality studies have concentrated on distinguishing among peatland types. Major ion chemistry is useful for differentiating among bog, poor fen, and rich fen. However, Iowa fens fall within one peatland type - rich fen, and major ion water chemistry does not appear to be useful for differentiation within a single type. However, only gross vegetative characteristics were observed during this study and in order to evaluate fully the relationship between water chemistry and vegetation, more detailed botanical studies would need to occur. Trace element chemistry as well as metal concentrations would also be useful.

Another question of interest is the effect of increased nutrient levels on fen vegetation. Observations at fen sites suggest that increased nutrient levels are leading to a displacement of the native vegetation. *Typha* species are often present in the areas where higher nitrate-nitrogen concentrations occur. Complicating any simple relationship is the time factor. Elevated concentrations of nutrients have generally only been prevalent in shallow ground-

**Table 1.** Excelsior Fen water chemistry.

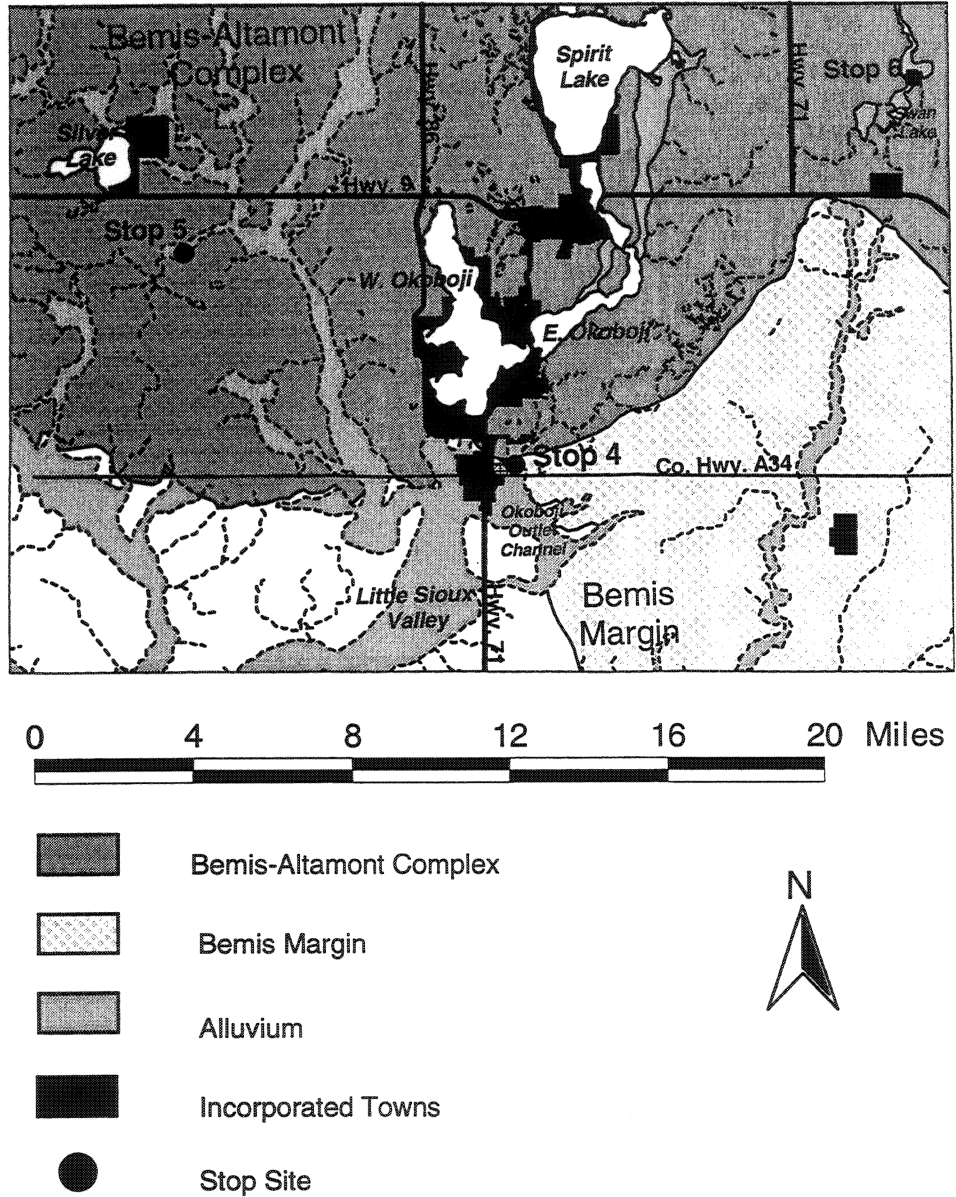
	<b>Alkalinity</b> (mg/L)	<b>Conductivity</b> (uS/cm)	<b>pH</b>	<b>Calcium</b> (mg/L)	<b>Sulfate</b> (mg/L)	<b>Nitrate</b> (mg/L)
<b>Sand &amp; Gravel</b>	341	538		109	113	<1
	332-354	485-640	6.8-7.2	96-122	110-115	
<b>Peat</b>	317	988		166	490	<1
	230-386	725-1500	7.1-7.4	156-176	383-597	

water in the last few decades and there may be a lag in biotic response to these increases. The concentrations in the incoming groundwater are lower than where massive vegetative replacement has been seen to occur, such as in the case with the high loadings typical of sewage outflow.

## EXCELSIOR FEN

Excelsior Fen is part of a cluster of fens in western Dickinson County (Figure 4). Holte (1966) defined twenty-six separate fens extending along both sides of a small drainage named Dug-Out Creek. In 1993, the U.S. Fish and Wildlife Service purchased most of this site including 17 of the 26 fens. This acquisition is part of the prairie-pothole restoration effort in Iowa and the Iowa DNR will be responsible for management of the site. Floristically, this complex is of very high quality and includes *Eriophorum angustifolium* (tall cottongrass), *Gentianopsis procera* (small fringed gentian), and *Triglochin maritimum* (large arrowgrass). Further details on the flora can be found in Holte (1966). One fen area, 1.6 acres in size was chosen for detailed study ("Fen 2" of Holte, 1966), and is located on a gentle, north-facing slope. Land around the site was used for pasture. The fen surface has several small discharge mounds. These are somewhat large areas, about 5 feet across, elevated about a foot or two above the peat surface.

The fens occur along a linked depression system developed on the Altamont-Bemis ice margin complex. A core upgradient of the fen shows surficial sediments of the Flack Mbr. of the DeForest Fm. over Dows Fm. diamicton and is unleached to the top. Deposits at the site consist of an unknown thickness of Morgan Mbr., resedimented diamicton and sorted sediments. Most likely Morgan Mbr. sediments form a drape over the Alden Mbr. basal till that cores the hummocks. Coring has shown a small sand body under the fen, often in a vertical relationship to the surrounding till. The peat is carbonate-rich and typically is gray in color. There are several layers of tufa in the peat which are often more abundant near the bottom. Maximum peat thickness was 11.8 feet. Cores through the discharge mounds encountered a thin diamicton (till) layer at the base of the peat underlain by a fine to medium sand. At one location over ten feet of sand was penetrated with surprising ease indicating that the sand was in a fluidized condition. Water flowed from this hole for several days until it was plugged. A peat sample from a depth of 8.8 feet was radiocarbon dated at  $2,550 \pm 80$  BP.



**Figure 4.** Map of Dickinson County showing the location of the Excelsior Fen Complex in relation to the former ice marginal position of the Bemis-Altamont Complex.

Water samples were collected in 1989 and 1990. Concentrations of most ions are typical for fens in the area, but are much lower than the other artesian site investigated, Silver Lake. Sulfate concentrations in the fen (383-597 mg/L) are higher than in the well (110 mg/L) and are higher than all other sites, except Silver Lake Fen. Sodium and magnesium concentrations were also higher in the well than the fen.

## REFERENCES

- Baker, R.G., Chumbley, C.A., Witinok, P.M., and Kim, H.K., 1990, Holocene vegetational changes in eastern Iowa: *Journal of Iowa Academy of Science*, v. 97, p. 167-177.
- Carpenter, Q.J., 1990, Hydrology and vegetation on a calcareous peat mound fen in southeastern Wisconsin: M.S. thesis, University of Wisconsin, Madison, Wisconsin.
- Chumbley, C.A., Baker, R.G., and Bettis, E.A. III, 1990, Midwestern Holocene paleoenvironments revealed by floodplain deposits in Northeastern Iowa: *Science*, v. 249, p. 272-274.
- Crum, H., 1988, *A Focus on Peatlands and Peat Mosses*: Ann Arbor, University of Michigan Press.
- Curtis, J.T., 1959, *The Vegetation of Wisconsin: An ordination of plant communities*: Madison, University of Wisconsin Press.
- Holte, K.E., 1966, A floristic and ecological analysis of the Excelsior fen complex in northwest Iowa: Ph.D. thesis, University of Iowa, Iowa City, 292 p.
- Moran, R.C., 1981, Prairie fens of northeastern Illinois: floristic composition and disturbance, *in* Stuckey, R.L. and K.J. Reese (eds.), *The Prairie Peninsula-in the shadow of Transeau: Proceedings of the Sixth North American Prairie Conference*, Ohio Biological Survey Notes #15, p. 164-166.
- Nelson, P.W., 1985, *The terrestrial natural communities of Missouri*: Missouri Department of Natural Resources and Missouri Department of Conservation, Jefferson City, Missouri.
- Orzell, S.L. and Kurz, D.R., 1986, Floristic analysis of prairie fens in the southeastern Missouri Ozarks, *in* Clambey, G.K. and R.H. Pemble (eds.), *The Prairie-past, present, and future: Proceedings of the ninth North American Prairie Conference*, Tri-College University, North Dakota State University, Fargo, North Dakota, p. 50-58.
- Pearson, J.A. and Leoschke, M.J., 1992, Floristic composition and conservation status of fens in Iowa: *Journal of the Iowa Academy of Science*, v. 99, p. 41-52.
- Thompson, C.A., Bettis, E.A. III, and Baker, R.G., 1992, Geology of Iowa Fens: *Journal of the Iowa Academy of Science*, v. 99, p. 53-59.
- Van Zant, K.L., 1979, Late-glacial and post glacial pollen and plant macrofossils from West Lake Okoboji, northwestern Iowa: *Quaternary Research*, v. 4, p. 358-380.
- Van Zant, K.L. and Hallberg, G.R., 1976, A late-glacial pollen sequence from northeastern Iowa: Sumner Bog revisited: *Iowa Geological Survey Technical Information Series No. 3*, 17 p.

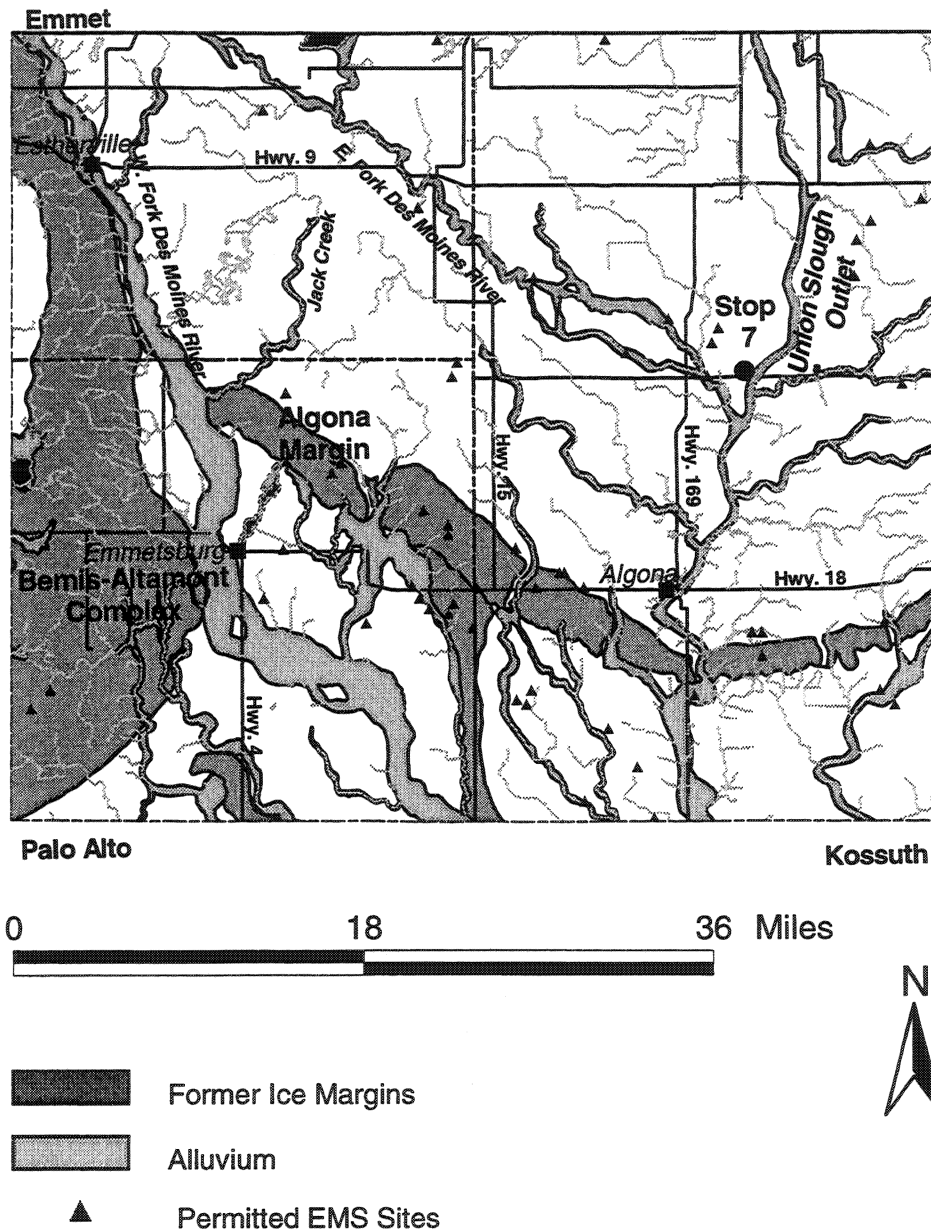




**STOP 6: MORGAN MEMBER OUTCROP  
SWAN LAKE AND CHRISTOPHERSON SLOUGH STATE  
WILDLIFE MANAGEMENT AREA**

Leaders: E. Arthur Bettis III, Deborah J. Quade, and Timothy J. Kemmis

At this stop we will have refreshments and examine a shallow outcrop of Morgan Mbr. deposits located in an area of hummocky topography. The outcrop has not been studied, but a quick examination by the first two leaders in January of 1996 revealed typical Morgan Mbr. lithologies. Look for stratified diamicton and interbedded sorted sediments. Small deformation structures such as low-amplitude folds and small faults may also be present. Also note that the matrix is not as dense as the Alden Mbr. (basal) till we saw yesterday at the National Gypsum quarry in Ft. Dodge. As in other areas of hummocky topography, linked-depression systems and linked drainages define the "hummocks."



**Figure 1.** Map of Kossuth, Emmet, and Palo Alto counties with the location of Union Slough, DML former ice margins, drainage systems, extent of outwash deposits, and EMS and ADW locations.

## STOP 7: UNION SLOUGH AND 55 MCGUIRE CORE NEAR BANCROFT

Leaders: E. Arthur Bettis III, Timothy J. Kemmis, and Deborah J. Quade

### UNION SLOUGH

Although Union Slough is just one of many abandoned glacial meltwater channels on the DML, it is one of the largest and most important (Figure 1). In Iowa and southernmost Minnesota, Union Slough is a constant-width, low-sinuosity valley. A ditch is present along its course, but no natural perennial stream was present during the Holocene. Although a well-defined valley is present, the channel floor reverses gradient in central Kossuth County about at the County Rd. A42 crossing. The southern portion drains south, and at its southern end the East Fork of the Des Moines River joins it and occupies its valley to the margin of the Algona advance. The northern portion drains north into southern Minnesota where it becomes the West Branch of the Blue Earth River.

In Minnesota within a few miles of the Iowa border, the morphology of Union Slough changes as it becomes the West Branch of the Blue Earth River. Headward erosion and stream meandering have destroyed the constant-width glacial character of the valley, and the valley morphology becomes one of a typical meandering Holocene stream. As such, the glacial character of the valley is no longer recognizable.

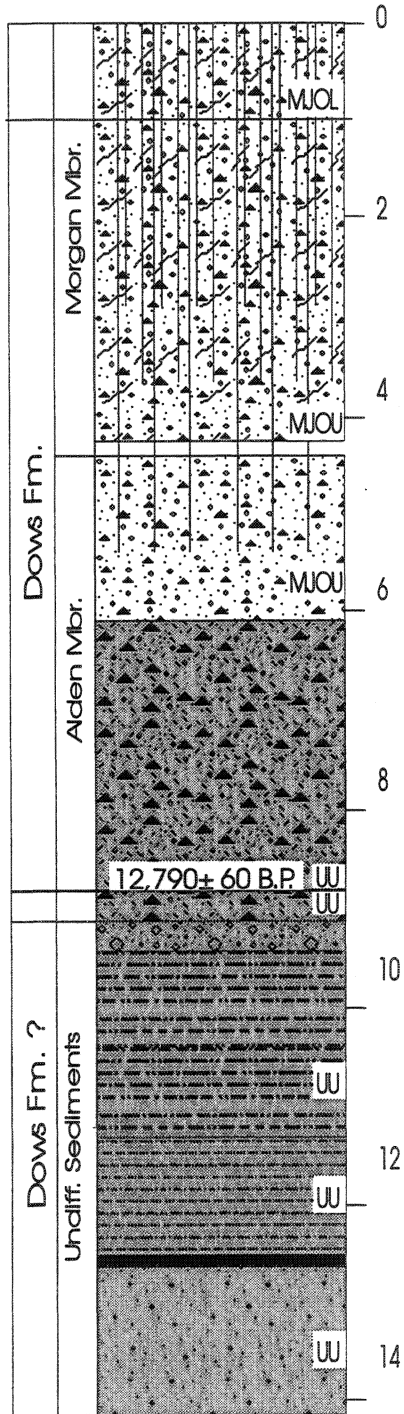
Union Slough is interpreted to have been the central drainage tunnel of the Des Moines Lobe during the Algona advance, much like the central subglacial drainageways of many modern valley glaciers. In addition, its development was contemporaneous with the Blue Earth and Minnesota River drainage systems. Other contemporaneous abandoned channels and linked-depression systems in turn link the Union Slough-Blue Earth system and its tributaries with both the East and West Forks of the Des Moines River. The geometry, interconnection, and morphology of these drainage systems suggest development from a glacial drainage network in stagnant ice following the Algona advance of the Des Moines Lobe. What is most impressive about this stagnation is that it occurred over an area of *several thousand* square miles.

### 55 MCGUIRE CORE

The 55 McGuire core was drilled as part of a Natural Resources Conservation Service research drilling program on the Des Moines Lobe. The site is located about 1.2 miles (1.9 km) southeast of where the trip crossed Union Slough on the west side of Union Slough. The core site is located in a small area of discontinuous ridges and isolated hummocks set onto a plain with lineated surface patterns transverse to the glacier-flow direction (category PL). The stratigraphic sequence is shown and described in Figure 2.

The upper nine meters of the section consists of about equal thicknesses of Morgan Mbr. and Alden Mbr. diamictons. The Alden Mbr. buries a sequence of stratified alluvial and pond deposits that extend to the base of the hole.

Wood collected from the lower 30 cm of the Alden Mbr. yielded a  $^{14}\text{C}$  AMS age of  $12,790 \pm 60$  BP (CAMS-24957). This is similar to other ages associated with the Algona ice advance and suggests that the overlying diamicton was deposited during that advance. The underlying alluvial and pond sediments are interpreted as proglacial sediment deposited as the glacier approached the site. If this is the case, the alluvial sediments may be underlain by more Dows Fm. diamicton in this area.



<i>Name:</i> <b>55MCGUIRE</b>		<i>County:</i> <b>KOSSUTH</b>
<i>Company:</i> <b>MCGUIRE FARM</b>		
<i>Parent Material:</i> glacial diamicton	<i>Vegetation:</i> picked row crop	
<i>Loc. (Q's):</i> NW, NE	<i>Sec.</i> <b>34</b>	<i>T.</i> <b>98N</b> <i>R.</i> <b>28W</b>
<i>Quad:</i> <b>BANCROFT</b>	<i>Elevation:</i> <b>1155 FT.</b>	
<i>Slope:</i> 1-2%	<i>Landscape Position:</i> low relief till plain	
<i>Date Drilled:</i> 10/17/95	<i>Date Described:</i> 10/17/95	
<i>Descrip. By:</i> E. A. Bettis III		

<i>Depth (meters)</i>	<i>Soil Horizon (w. zone)</i>	<i>Description</i>
<b>DOWS FORMATION</b>		
<b>Morgan Mbr.</b>		
0-0.9	MJOL	loam diamicton (Dms), upper 0.9m is leached and has surface soil developed in it.
0-4.4	MJOU	loam diamicton (Dms), weakly stratified, few thin stringers of medium to coarse sand and pebbly sand, gradual boundary
<b>Alden Mbr.</b>		
4.4-6.1	MJOU	loam diamicton (Dmm), few thin stringers of medium to coarse sand, denser than above, abrupt lower boundary
6.1-9.1	UU	loam, diamicton (Dmm), wood and plant macrofossils in interval 8.5-9.1 m, 12,790±60 B.P. on wood (CAMS-24957), abrupt boundary
<b>Undiff. Sediments</b>		
9.1-9.5	UU	pebbly coarse sand (Sm), abrupt boundary
9.5-11.3	UU	silt [F(sc)], laminated, clear lower boundary
11.3-12.5	UU	silty clay [F(sc)], laminated, abrupt lower boundary
12.5-12.6		organic mat, abrupt lower boundary
12.6-14.1	UU	sandy loam (Sm), coarsens downward from fine sandy loam to coarse sandy loam, upper 0.6 m contains few small gastropod shells

Figure 2. Stratigraphic log and description for the 55 McGuire Site.

## **STOP 8. GROUNDWATER MONITORING AT AN EARTHEN MANURE-STORAGE STRUCTURE**

Leaders: Deborah J. Quade, Robert D. Libra, and Lynette S. Seigley

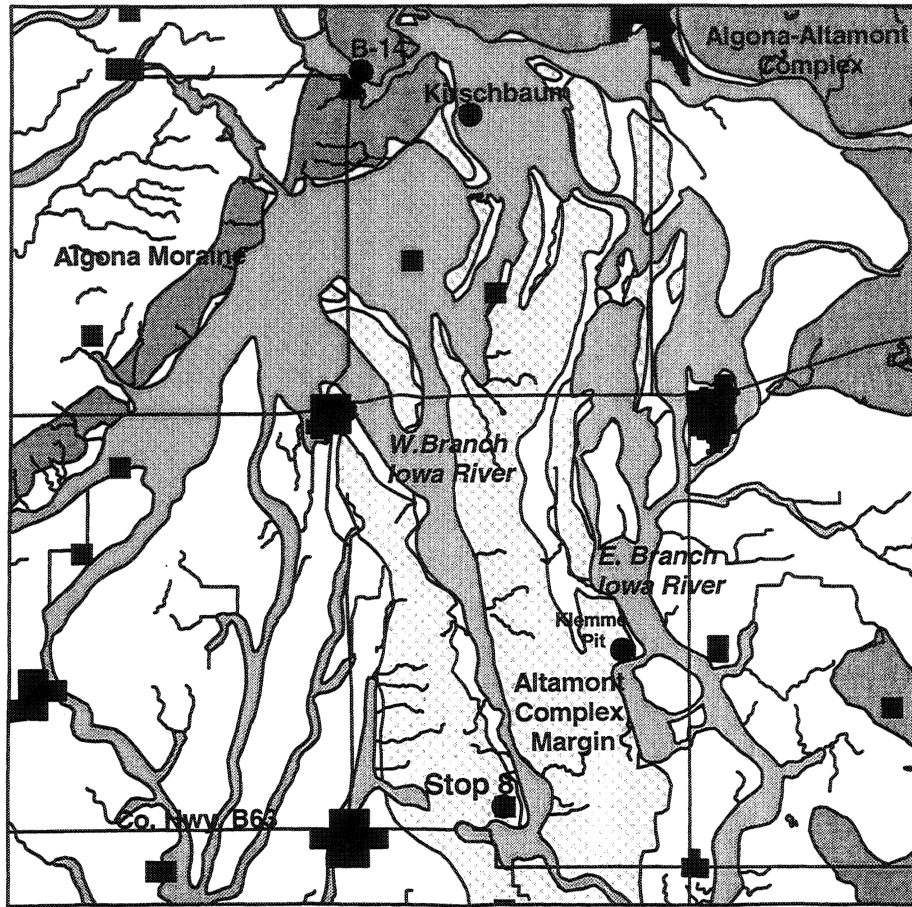
### **INTRODUCTION**







Groundwater quality has been monitored for two years in the immediate vicinity of three newly-constructed earthen manure storage (EMS) structures in Iowa. These structures are located in areas with differing surficial geologic materials: the Late Wisconsinan deposits of the Des Moines Lobe (DML), the Pre-Illinoian deposits of the Iowan Erosion Surface (IES), and the thick loess of western Iowa (WI). Three to seven shallow (<25 ft.) monitoring wells were installed around each structure. At two sites, wells were drilled through the berm structure on the downgradient side, while the third structure is ringed by a drainage tile that serves as a near-structure sampling point. Water levels are measured and water samples are collected monthly for nitrate-N, ammonium-N, fecal coliform bacteria, and chloride analysis. Samples are analyzed quarterly for total organic carbon, sulfate, phosphate, and other parameters. Liquid manure samples have been collected and analyzed from two of the three structures.

Seepage of liquid has been detected at the DML and IES sites. Indications of seepage have been similar at all affected monitoring wells and include: the decline or disappearance of nitrate-N and sulfate, likely in response to the anaerobic nature of the liquid; and an increase in concentrations of chloride and total organic carbon. Chloride concentrations in the berm well at the DML site are 50% of those measured in the liquid waste and, at the IES site, chloride concentrations in the berm well are equal to those in the liquid waste. Concentrations of nutrients, such as ammonium-N, phosphorus, and potassium, have currently not increased, indicating these species are being adsorbed and retained on manure solids or the compacted soils at the base of the structures. Fecal coliform bacteria have been sporadically detected in the berm wells, but are not consistently transported from the structures. At this stop we will discuss the livestock waste handling system, the hydrogeologic setting, and the results from monitoring the effect of a Des Moines Lobe EMS structure on groundwater quality during its first two years of operation.

### **LIVESTOCK WASTE HANDLING SYSTEM**

The DML site is located in southern Hancock County (Figure 1). This is a family owned and operated facility. The owners of this facility operate a 4,500-hog finishing operation and farm 370 acres, primarily in a corn and soybean rotation. An earthen basin is used to store the manure from the hog operation. Very little biologic treatment of manure occurs in an earthen basin, thus preserving much of the nitrogen (N) content of the manure. Lagoons, on the other hand, are designed to anaerobically treat the manure and reduce the N content. The solids along with much of the phosphate (P) and potassium (K) settle to the bottom of the lagoon, and ~70-80% of the nitrogen volatilizes to ammonia gas. Lagoons tend to be utilized by operations with a large number of hogs (>5000), and operations that have a small land base available for manure application. The operators of the DML site view the manure as a



-  Algona Margin
-  Altamont Complex Margin
-  Alluvium
-  Incorporated Towns
-  Stop Site, Points of Interest
-  EMS Sites

**Figure 1.** Map of Hancock County with DML ice margins, drainage systems, extent of outwash deposits, and EMS and points of interest.

resource and apply it as a fertilizer to their available land base, thus reducing their purchase of commercial fertilizer.

The earthen basin is constructed of locally derived materials, which are primarily diamicton of the Morgan Mbr. To meet state requirements, the earthen basin is designed to limit seepage to no more than 1/16 inch/day and to hold manure for up to 240 days. The lagoon has a capacity or total storage of 250,000 cu ft. or approximately 1.6 million gallons of manure. Manure is pumped out of the earthen basin twice a year, in late spring and late fall. On average, ~900,000 to 1 million gallons is pumped each time. The pumped slurry is applied by a custom applicator who uses an "umbilical cord" injection system. With the "umbilical cord" method, manure is pumped directly from the earthen basin through a hose to a tractor unit in a field adjacent to the earthen basin. The tractor unit directly injects the manure a few inches below the surface. Manure is continually pumped as the tractor moves across the field. The operators of this facility utilize a crop consultant to do a grid soil sampling of the fields to determine the nutrient needs of the fields where the manure will be applied. The consultant prepares a grid map of the farm showing the levels of P, K, and N currently available. This grid map allows the custom applicator to modify application rates of manure to a field to place additional manure where soil nutrient levels are low or reduce manure rates where nutrient levels are high. It costs an estimated \$6,500 per application (\$13,000 a year) to use the "umbilical cord" injection method. It is estimated that the fertilizer value of this manure is \$20,000-\$21,000. Despite the high costs of custom application, the operators still save \$7000-\$8000 a year in fertilizer costs and utilize a much more environmentally friendly application method.

## METHODS

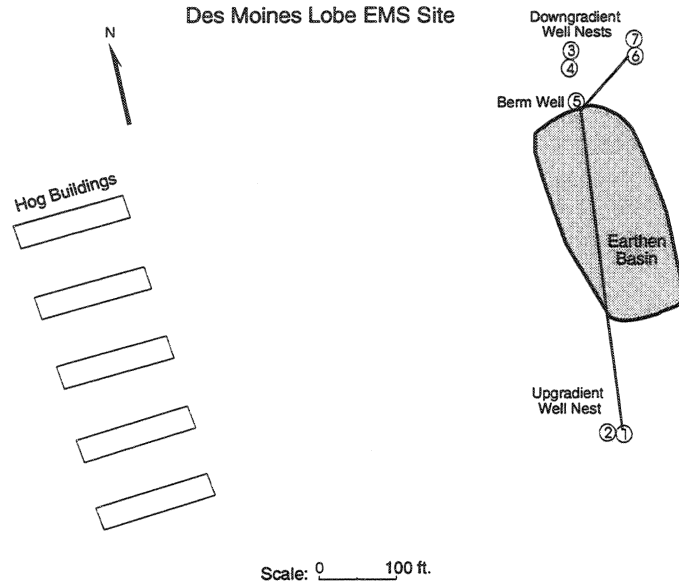
In December 1993, the Iowa Department of Natural Resources-Geological Survey Bureau (IDNR-GSB) installed seven monitoring wells around the basin. Two wells were nested upgradient of the earthen basin, one well was installed through the downgradient berm wall, and four wells were installed in two well nests downgradient of the earthen basin (Figure 2). The wells were constructed of 1-1/2 inch PVC pipe and 5-foot, 0.01 slot-size PVC screens. The wells range in depth from seven to twenty feet. Polyethylene tubing, 1/4" in diameter, was dedicated to each well and installed in the well by drilling an angled hole in the well casing wall. Samples are drawn from the wells using a vacuum hand pump. Several well volumes are drawn from the wells prior to collecting samples.

Since January 1994, water levels have been measured and water samples have been collected monthly at this site. Water quality analyses are performed by the University of Iowa Hygienic Laboratory. Samples are analyzed for: nitrate-N, ammonium-N, fecal coliform bacteria, and chloride. Quarterly samples are also analyzed for total organic carbon and a number of other nutrients and anions (e.g., sulfate, phosphate).

## HYDROGEOLOGIC SETTING

The DML site is located in a linked-depression system associated with the Altamont Moraine II (Figure 1). This hummocky plateau region (category HP) is characterized by



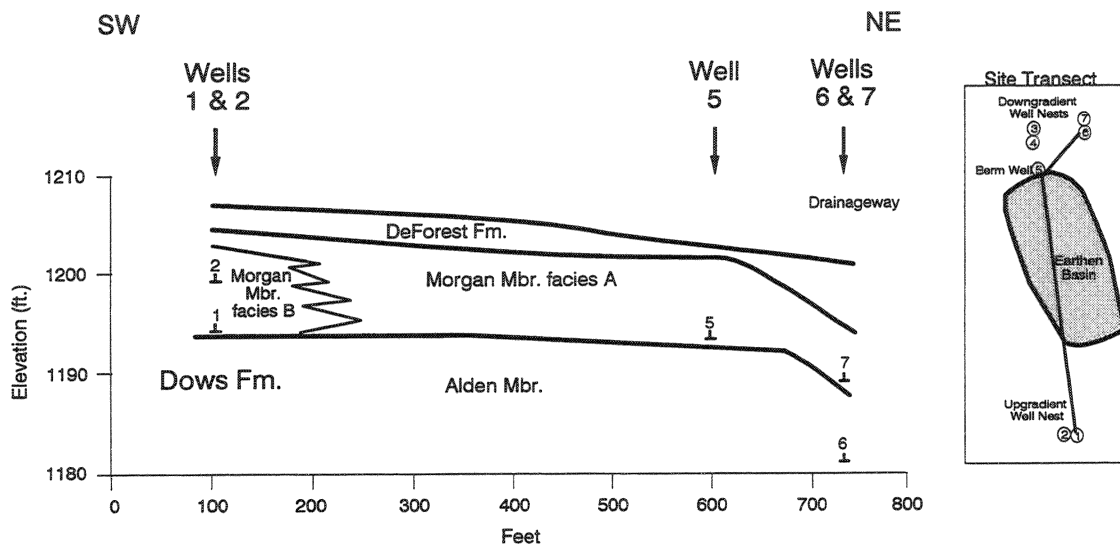


**Figure 2.** Diagram of DML Site showing location of storage basin, monitoring wells, and hog buildings.

moderate relief, and circular to rounded, irregularly shaped “hummocks” that are defined by linked-depression systems. Drilling indicates that the stratigraphy at the DML site is similar to the Davis Transect in Humboldt County (refer to Stop 3 discussion). Figure 3 is a SW to NE cross section of the DML site. This transect is representative of a part of the linked-depression system which developed within the ice; sand and gravel bodies are discontinuous across the depression axis. In this moderate relief hummocky area, the Alden Mbr. cores the hummocks, while the Morgan Mbr. facies A and B sediments flank the lower side slopes of the hummock and extend into the drainageway. Figure 4 is a detailed description from Wells 6 and 7, the stratigraphic sequence at this nest is representative of linked-depression system stratigraphy. Wells 3 and 4 are not included in the transect but are completed in Morgan Mbr. facies A and B, again demonstrating the discontinuous nature of sand and gravel bodies associated with linked-depression systems.

### Hydrologic Implications

Linked-depression systems link the hummocky uplands and serve as an “interconnected” drainage network to nearby streams, (i.e. the West Branch of the Iowa River at this site). Figure 1 is a map of Hancock County that indicates the location of former ice margins, the extent of associated outwash (alluvial aquifers) and the locations of permitted EMS sites. Valley train deposits, outwash plains, and alluvium are mapped as alluvial aquifers. Discontinuous and continuous sand and gravel bodies associated with the Morgan Mbr. are included in the alluvial aquifer designation for several reasons: 1) the highly permeable nature of these units; 2) the occurrence in and adjacent to drainageways; and 3) their potential shallow hydrologic connection to nearby streams. Linked-depression systems may be viewed as a relatively high permeability, preferential pathway for shallow groundwater



**Figure 3.** Schematic diagram of SW to NE drilling transect and well depths at the DML Site—Hancock County, IA.

movement. However, the hydrologic role of the systems is complicated by the discontinuous nature of the sand and gravel bodies, and the presence of minor topographic “saddles” between individual depressions.

### PREVIOUS INVESTIGATIONS OF EMS STRUCTURES AND GROUNDWATER QUALITY

A number of monitoring studies have attempted to evaluate the effects of EMS structures on groundwater quality. Parker et al. (1994) offer a comprehensive review of the literature on the topic. Most of these studies were conducted in areas with relatively permeable, coarse-grained surficial deposits. EMS structures built in such environments have been shown to cause increased concentrations of chloride and nutrients, such as ammonium-N and nitrate-N, phosphorus, potassium, and other waste constituents in nearby (typically within about 400 feet) shallow groundwater. In a number of these studies, the concentration of waste constituents, while showing significant increases when a structure is first used, begin to decline at some point in time (Miller et al., 1985; Rowsell et al., 1985; Ritter et al., 1984; Sewell, 1978; Westerman et al., 1993). This response occurred within several months to several years, and is generally believed to result from sealing of the bottom and sides of the structures by the waste solids. Laboratory investigations suggest this sealing results from the physical plugging of the permeability and porosity of the structure’s bottom and sides; biological processes at the waste-structure interface may add to the formation of a seal (Barrington and Jutras, 1983).

Hegg et al. (1979) and Westerman et al. (1993) noted a variable pattern of contamination in near-structure wells, which they ascribed to localized leakage from parts of the structure,

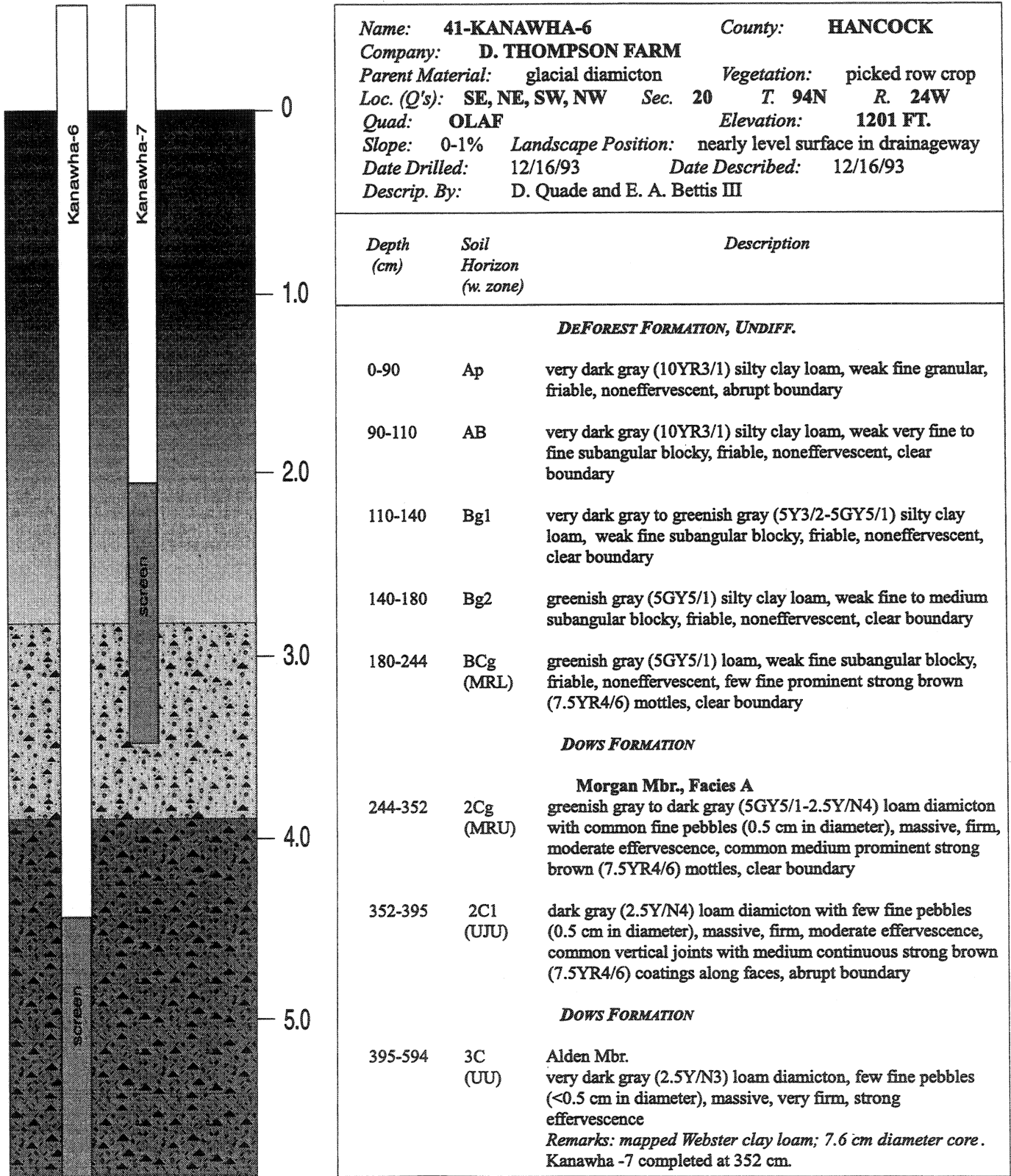


Figure 4. Stratigraphic log and description for Wells 6 and 7 at the DML Site.

possibly as a result of incomplete sealing. Ciravalo et al. (1979) suggested that lagoon seals could be disrupted by either the drying of exposed soils and wastes on lagoon embankments when wastes are removed, or by gas release from microbial activity occurring below the seal. This could result in the intermittent release of fluids and waste constituents from EMS structures while the seal reformed. The investigations of Westerman et al. (1993) in particular show the range of effects that EMS structures may have on shallow groundwater quality. While some of the downgradient (“downflow”) wells they monitored showed the rising-falling concentration trend that appears to accompany sealing, other wells showed increasing concentrations during a five-year period, while yet others remained at “background” levels throughout the monitoring.

Nitrate-N is a contaminant of concern in investigations of EMS structures. Nitrate is not typically a significant constituent of liquid livestock wastes; rather, nitrogen is present as ammonium- or organic-N in this anaerobic liquid. However, seepage from EMS structures has been shown to generate relatively high concentrations of nitrate in downgradient groundwater (Westerman et al., 1993). As seepage enters the groundwater system and flows away from the structure, aerobic conditions are often encountered, resulting in the oxidation of ammonium- and organic-N to nitrate.

Miller et al. (1976) examined the accumulation of nutrients in soils beneath four earthen hog waste lagoons in Ontario. Two of these were built on relatively sandy materials, similar to those discussed above. The others were built on either clay-loam glacial till or lacustrine clays — fine-grained materials similar to those present in Iowa. Significant accumulation of nutrients occurred to depths of over 10 feet below the lagoons built on sandy deposits. In contrast, the nutrient build-up was largely contained within one foot of the bottom of the lagoons built on fine-grained deposits.

## WATER-QUALITY RESULTS

Background samples were collected from the monitoring wells in January 1994, prior to filling the earthen basin. Concentrations of nitrate-N, chloride, and sulfate in six of the wells were relatively uniform, ranging from 15-20 mg/L  $\text{NO}_3\text{-N}$ , 18-35 mg/L chloride, and 24-38 mg/L sulfate. The relatively uniform concentrations of these ions, and the relatively high  $\text{NO}_3\text{-N}$  concentrations, result from the long history of row-crop agriculture on the land where the basin was built. Background values from the Kan-6 well, which is the only well fully completed in the Alden Mbr., were much different than the other six wells. Nitrate-N was lower (<1 mg/L), while chloride (40 mg/L) and sulfate (94 mg/L) values were higher than concentrations from the other six wells at this site. The lack of nitrate at this well suggests denitrification occurs within the unoxidized Alden Mbr. sediments. A slurry sample from the basin itself was collected in December 1994. That sample contained 840 mg/L of chloride, <0.1 mg/L  $\text{NO}_3\text{-N}$ , and 2200 mg/L ammonium-N. Concentrations of these liquid-waste constituents likely change with time, for a variety of reasons (Westerman et al., 1993). However, these concentrations indicate the general strength of the contaminant source.

Indications of seepage from the basin to the water table have been detected at the berm well and at one downgradient well nest (wells #6 and #7). Figure 5 shows pertinent monitoring results from the berm well. The first sign of seepage is a sharp decline in nitrate-N concentrations that occurred in late spring of 1994. Seepage from a manure-holding structure would be highly anaerobic; nitrate is unstable in anaerobic environments, being

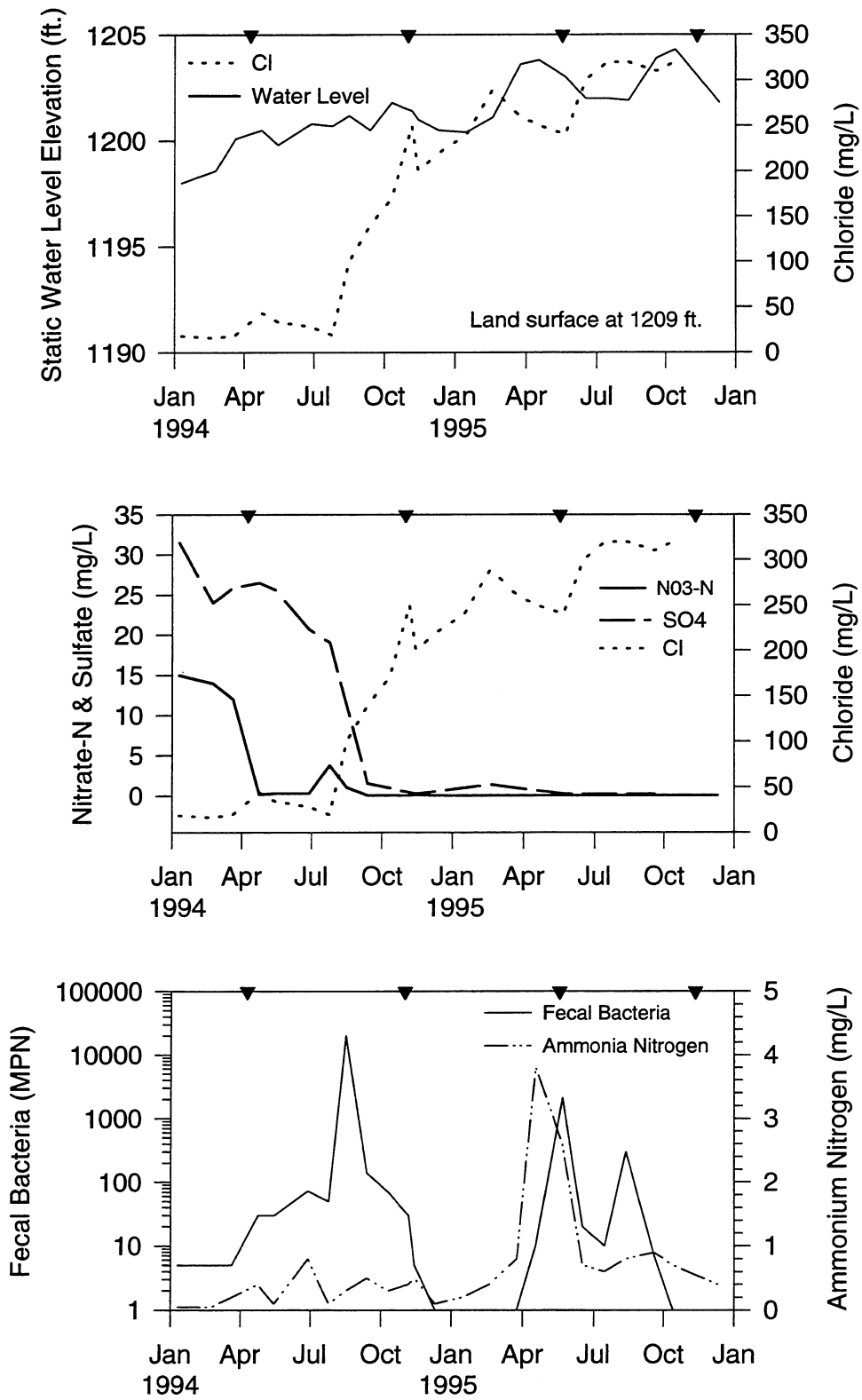


Figure 5. Water quality results from the #5 berm well. Inverted triangles represent pump out periods.

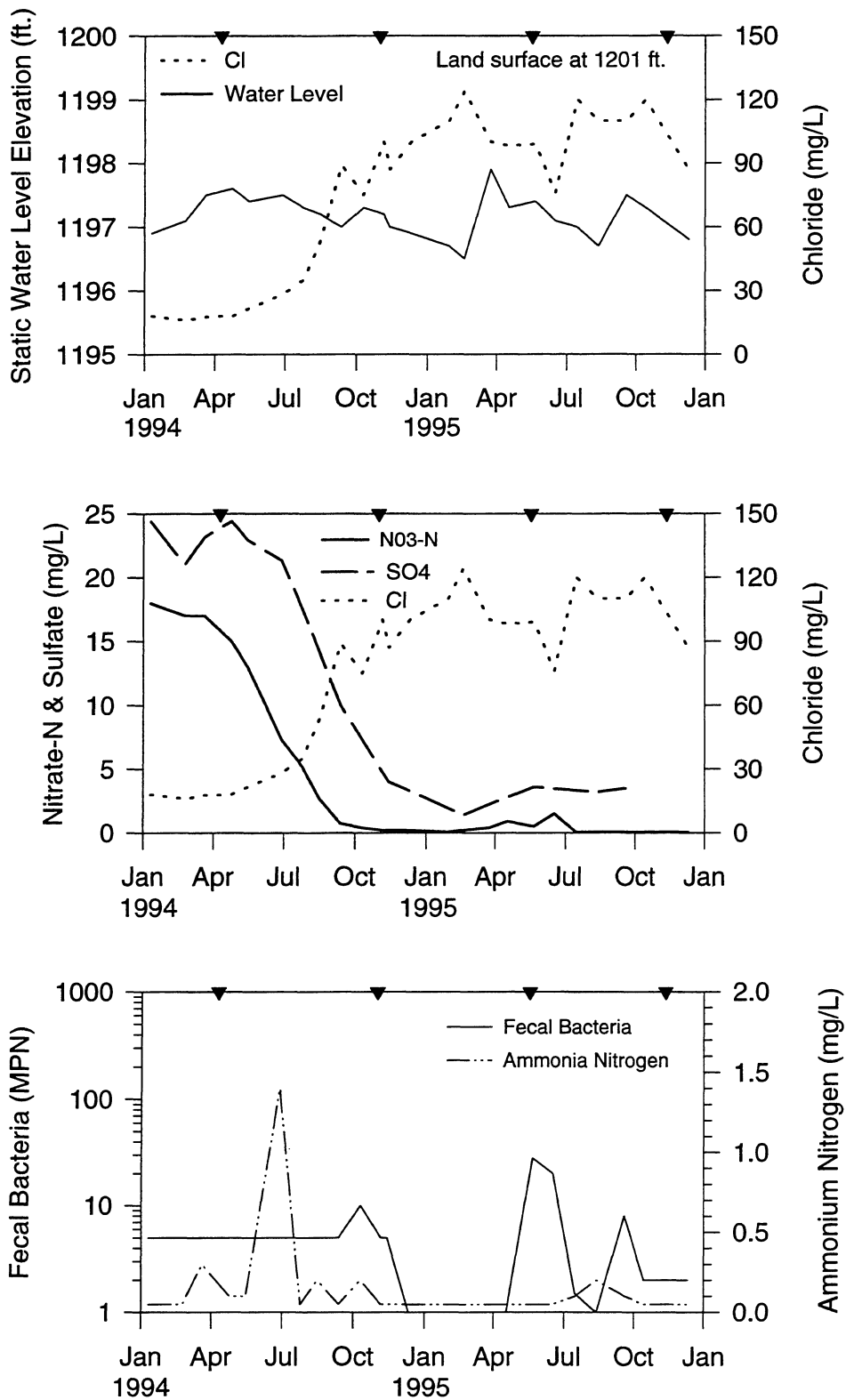


Figure 6. Water quality results from the #7 downgradient well. Inverted triangles represent pump out periods.

reduced to nitrous oxides and nitrogen gas. The second indication of seepage is the slow decline in sulfate concentrations during the period of monitoring. Sulfate is also unstable in anaerobic environments, and is reduced to hydrogen sulfide gas. The third indicator of seepage is the increase in chloride concentrations, from less than 30 mg/L at the beginning of the period to over 300 mg/L by the fall of 1995. Although not shown on the graph, the increase in chloride was accompanied by—and possibly preceded by—increased concentrations of total organic carbon. Concentrations of fecal coliform bacteria have shown sporadic “spikes,” but high concentrations are not sustained. Concentrations of the nutrients phosphate and ammonium-N have not shown increases, suggesting they are being retained on manure solids or the materials immediately beneath the basin or adsorbed. If ammonium-N was being transported from the basin as readily as chloride, ammonium-N concentrations at the berm well would approach 800 mg/L. Oxidation of this ammonium-N would generate a similar concentration of nitrate-N.

The berm well has also responded hydrologically to the seepage from the basin (Figure 5). Water levels have generally increased during the period of monitoring, trending towards the level of the waste liquid in the basin. This trend is interrupted when the liquid wastes are pumped out; water levels in the berm well decline in response. Concentrations of seepage constituents do not increase significantly in the periods following waste removal, as suggested by Ciravolo et. al. (1979). Rather, chloride concentrations show a tendency to decline or level off during these periods. This is likely in response to the reversal in hydraulic gradient caused by pumping out the basin.

Indications of seepage from the basin have also been detected at the downgradient well nest of well #6 (19 feet deep) and well #7 (12 feet deep). These wells are located about 150 feet downgradient from the structure. Figure 6 illustrates that water quality trends at these wells are similar to those at the “berm” well—a decline in nitrate-N and sulfate concentrations and an increase in chloride concentrations. However, chloride concentrations at this well nest are lower than the berm well, typically by about 60%. As was the case for the berm well, transport of ammonium-N and phosphate has not occurred at wells #6 and #7, while organic carbon concentrations have increased. Fecal coliforms are rarely detected at these wells.

Trends in water quality are less clear at the other downgradient well nest (well #3, 13 ft. deep and well #4, 7 ft. deep). Chloride concentrations have remained relatively unchanged at these sites, however, nitrate-N and sulfate concentrations have shown a decreasing trend (approximately one-half of the background concentrations), while total organic carbon concentrations have increased sharply. At wells #5, #6, and #7, decreases in both nitrate-N and sulfate concentrations preceded chloride increases by several months. If decreases in nitrate-N and sulfate are precursors to chloride increases, then recent results for nitrate-N and sulfate suggest an increase in chloride concentrations may occur in the near future.

The IES site, a two-stage lagoon site, located in eastern Iowa and constructed on pedisegment and weathered Pre-Illinoian diamicton, has shown very similar trends to the DML site. Samples have been collected since October 1993 from the 5 monitoring wells installed at this site. Indications of seepage from the lagoon have been noted at the berm well and two downgradient wells. Monitoring results show that nitrate-N concentrations were low initially and have remained low; the lagoon was not built on recently row-cropped land. The main indication of seepage is the increase in chloride and organic carbon concentrations that has occurred particularly since September 1994. Sulfate concentration have shown a decline, and concentrations of phosphate, ammonium-N, and fecal coliform bacteria have remained

low. Indications of seepage have not been detected at the western Iowa site. If seepage is occurring from this basin, it may be masked by the large volume of shallow groundwater discharged by the tile-drain that rings the site.

## DISCUSSION

The results discussed above are from only three of the over 500 earthen manure-storage structures that have been constructed in Iowa in the last 5 years. These structures are relatively new, having been in use two years or less. Monitored sites are also “moderately-sized” structures. Therefore, this study should be considered a preliminary look at the effects of EMS structures on groundwater quality. The results indicate that seepage of waste fluid to the water table is occurring at the DML and IES sites. Indications of this seepage are similar at all affected monitoring wells, and include rising concentrations of chloride and organic carbon, and declining concentrations of sulfate and nitrate-N. Concentrations of phosphate and ammonium-N have not changed from background conditions. Note that if ammonium-N is not retained in a waste structure, it may be transported by groundwater away from the structure to an aerobic environment and converted to nitrate. Fecal coliform bacteria do not appear to be transported from these structures by groundwater. If numerous other structures are responding similarly, this study suggests a need to avoid citing EMS structures in environmentally sensitive areas. On the Des Moines Lobe, this would include linked-depression systems, where preferential pathways for groundwater movement to nearby wetlands, streams and alluvial aquifers may exist.

The main indicator of fluid movement from the structures, chloride, is a naturally-occurring constituent of water. When combined with sodium, it comprises table salt. There is a U.S. EPA Secondary Drinking Water Standard, applicable for Public Water Supplies, established for chloride at 250 mg/L. At concentrations above this secondary standard, chloride may give drinking water a salty taste; there are no health-related implications for this standard. Seepage from the sites currently monitored is very unlikely to impact drinking-water supplies.

The monitoring to date suggests these structures are having a lesser impact on groundwater quality than most of those cited in the literature. This, in all probability, is the result of Iowa’s relatively fine-grained soils and their significant clay content, which allow for less seepage and which adsorb species such as ammonium-N. However, the results are viewed as preliminary, and are from less than one percent of the permitted structures in the state. Are they typical of structures in Iowa? Are similar results to be expected of other structures constructed of and on similar geologic materials? Will the character of the fluid seeping from the structures change as structures age? Finally, can these findings be extrapolated to larger EMS structures?

Acknowledgments—Funding for this project is provided, in part, by the (U.S. EPA)-Region VII-Nonpoint Source Program. We acknowledge the support of the University of Iowa Hygienic Laboratory, particularly the efforts of Nancy Hall and George Hallberg. Ubbo Agena, IDNR-Environmental Protection Division, and George Hallberg were instrumental in planning and securing funding for this work. Staff from the U.S.D.A.-Natural Resources Conservation Service surveyed and provided elevations for pertinent points at each site. Last, and far from least, we acknowledge the owners of the sites for cooperating and taking an active interest in this venture.





## REFERENCES

- Barrington, S.F., and Jutras, P.J., 1983, Soil sealing by manure in various soil types: A.S.E.A. Paper #83-4571, St. Joseph MI, 17 p.
- Ciravolo, T.G., Martens, D.C., Hallock, D.L., Collins, E.R. Jr., Korngay, E.T., and Thomas, H.R., 1979, Pollutant movement to shallow ground water tables from anaerobic swine waste lagoons: *Journal of Environmental Quality*, v. 8, #1, p. 126-130.
- Hegg, R.O., King, T.G., and Wilson, T.V., 1979, The effects of groundwater from seepage of livestock manure lagoons: Clemson University WRRRI Technical Report #78, Clemson, SC.
- Miller, M.H., Robinson, J.B., and Gallagher, D.W., 1976, Accumulation of nutrients in soil beneath hog manure lagoons: *Journal of Environmental Quality*, v. 5, #3, p. 279-282.
- Miller, M.H., Robinson, J.B., and Gillham, R. W., 1985, Self-sealing of earthen liquid manure storage ponds: I. A case study. *Journal of Environmental Quality*, v.14, #4, p. 533-538.
- Ritter, W.F., Walpole, E.W., and Eastburn, R.P., 1984, Effect of an anaerobic swine lagoon on groundwater quality in Sussex County, Delaware: *Agricultural Wastes*, Elsevier Applied Science Publishers, England, p. 267-284.
- Rowell, J.G., Miller, M.H., and Groenevelt, P.H., 1985, Self-sealing of earthen liquid manure storage ponds: II. Rate and mechanism of sealing: *Journal of Environmental Quality*, v. 14, #4, p. 539-543.
- Parker, D.B., Schulte, D.D., Eisenhauer, D.E., and Nienber, J.A., 1994, Seepage from animal waste lagoons and storage ponds - regulatory and research review, *in Proceedings, Great Plains Animal Waste Conference on Confined Animal Production and Water Quality: Balancing Animal Production and the Environment*, Great Plains Agricultural Council publication #151, p 87-98.
- Sewell, J.L., 1978, Dairy lagoon effects on groundwater quality: *Transactions of the A.S.A.E.*, v. 21, p. 948-952.
- Westerman, P.W., Huffman, R.L., and Seng, J.S., 1993, Swine-lagoon seepage in sandy soil: A.S.A.E. paper #93-4527, 32 p.



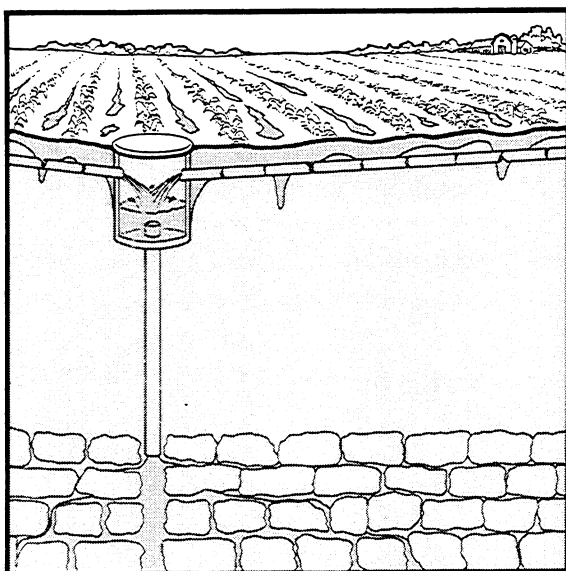
## STOP 9. AGRICULTURAL DRAINAGE WELLS AND GROUNDWATER QUALITY

Leaders: Robert D. Libra, Deborah J. Quade, and Angela Rieck-Hinz

### INTRODUCTION

Iowa agriculture benefits from two important natural resources: the rich soils that blanket the state's landscape and sufficient precipitation, in most years, to produce large crop yields. While adequate precipitation is essential for crop growth, many of Iowa's soils, particularly those on the Des Moines Lobe, are poorly drained and at times contain excess water that can hinder field operations or ruin crops. In these areas, farm fields are often artificially drained by buried tile lines leading to drainage ditches or streams. Another, but less commonly used method is the agricultural drainage well (ADW), a drilled shaft that funnels excess drainage water into underlying bedrock aquifers (Figure 1). The upper parts of these wells are often cistern-like structures that form the discharge point for tile-drainage lines; some wells are also designed to take surface runoff. ADWs are generally 5 to 10 inches in diameter and are cased from the land surface into the underlying bedrock. Most ADWs in Iowa are believed to have been drilled more than 60 years ago. Construction of new drainage wells has been illegal since 1957. ADWs are considered Class 5 Underground Injection Wells by the U.S. Environmental Protection Agency (U.S. EPA). Virtually all ADWs in Iowa discharge into fractured carbonate aquifers; these strata can accept large quantities of drainage water and they have a lesser susceptibility to clogging with sediment and other suspended matter, compared to clastic aquifer materials (e.g., sand or sandstone). These carbonate aquifers are also excellent sources of groundwater for domestic, industrial, and municipal water supplies.

The quality of water ADWs deliver to aquifers depends upon several factors, including: whether tile drainage, surface runoff, or both are discharging to the well; land use and



**Figure 1.** Schematic diagram of an ADW designed to accept tile drainage water.

management of the area drained; and climatic factors that control the timing and volume of infiltration and runoff (Libra et al., 1994). Cooperative studies by the Iowa Department of Agriculture and Land Stewardship (IDALS) and Iowa State University (ISU) are currently providing further documentation of these relationships (IDALS, 1994; Baker et al., 1996). Water entering ADWs from tile drainage typically contains nitrate-N concentrations in the 15-50 mg/L, and 1-10 µg/L of commonly used herbicides (Hallberg et al., 1986). Direct surface runoff into ADWs may contain herbicides in the 10-100 µg/L range, while nitrate-N concentrations are commonly less than 10 mg/L (Baker et al., 1985). Influent surface water could contain bacteria and potentially pathogenic organisms that are less likely to occur in tile effluent. Tile drainage and surface water inflow to ADWs is generally intermittent. Beyond the routine delivery of drainage water with typical agricultural contaminants to aquifers, ADWs pose an additional risk to groundwater quality. ADWs are pathways by which substances accidentally spilled on the land surface or discharged to a tile line may directly enter groundwater. Some ADWs are connected to drainage systems that accept water from road ditches. Therefore, spills or leaks of harmful substances into these ditches could quickly and directly impact groundwater supplies.

## ADWS IN IOWA

The actual number of functioning ADWs in Iowa is not precisely known. ADWs have recently been registered with both the Iowa Department of Natural Resources (DNR) and the U.S. EPA. These two registration lists largely overlap, though not completely. Both lists are incomplete, in all probability, and both likely contain registrations for features that are not really ADWs. Staff from IDALS and the DNR-Geological Survey Bureau (DNR-GSB) merged the registration lists to develop a composite tabulation (Libra and Hallberg, 1993). The merged list suggested there are 442 unique ADWs registered in Iowa. Registration information concerning locations, ADW depths, and areas drained was supplied by ADW owners, and used to derive summary statistics for the ADWS in Iowa (Libra and Hallberg, 1993); these statistics are used in this guidebook. Subsequent field checking by IDALS and ISU, as part of an evaluation of drainage alternatives for ADWs, indicated that about 100 of these were not actually drainage wells, or were non-functional drainage wells (Lemke et al., 1995). This would suggest there are about 340 ADWs in-state, plus some unknown number that were not registered or otherwise identified.

Information concerning the area drained was reported for 297 registered wells (67%). Accurate estimation of the area drained is dependent upon determining the location and extent of the subsurface drainage systems connected to the ADWs, which are often poorly known. Assuming the registration data are representative and reasonably accurate, the tile and/or surface drainage from an estimated 46,750 acres (about 73 square miles) discharges to ADWs; Lemke et al. (1995) estimated the 340 ADWs that have been field verified drain about 25,000 acres. Reported areas drained by individual ADWs range from 2 to 720 acres (Table 1). The median drainage area was 80 acres; 25% drain 40 acres or less, and 25% drain 140 acres or more. Reported depths of ADWs range from 12 feet to 400 feet. The median reported depth is 85 feet; 25% are 50 feet deep or less, and 25% are 140 feet deep or deeper.

From a statewide perspective, as suggested by the estimated number of ADWs and the area they drain, these wells are relatively minor features; the area drained accounts for less than 0.15% of the area of the state. The Iowa State-Wide Rural Well-Water Survey (SWRL; Hallberg et al., 1990; Kross et al., 1990) provided statistically valid information on rural well-

**Table 1.** Summary of ADW drainage areas and depths from registration reports.

	Minimum	Maximum	1st Quartile	Median	3rd Quartile
ADW drainage area, acres:	2	720	40	80	140
ADW depth, feet:	12	400	50	85	140

water quality and site characteristics for Iowa. As part of the survey, detailed questionnaires and on-site inventories were completed that included an assessment of whether ADWs were located on the property. Statewide, the SWRL sample estimates <0.6% of rural residences have ADWs on their property. Sinkholes are natural features that can have impacts on groundwater quality similar to ADWs. For perspective, there are about 30 times as many sinkholes in Iowa as there are ADWs. The SWRL survey indicates that sinkholes were present on, or in the vicinity of 2.1% of rural residences.

### COUNTY AND LOCAL PERSPECTIVES

While ADWs are relatively minor features at the state level, over 80% of the registered ADWs are concentrated within only four counties: Humboldt, Pocahontas, Wright, and Floyd; all but Floyd County are located on the Des Moines Lobe. About 90% of the projected area in the state drained by ADWs occurs in these four counties, and 73% is within the three Des Moines Lobe counties. Table 2 summarizes, on a statewide basis and for the four “main ADW” counties, the estimated number of ADWs and area drained. Figure 2 shows the distribution of (state-registered) ADWs in Iowa. The state-federal registration lists indicate the largest number of ADWs occur in Humboldt County where 164 are registered. Of the four main ADW counties, Wright County has the fewest registered wells, 41. Outside these four counties, only 82 ADWs were registered. The largest number found in any other county was 13, in Mitchell County. In each of the main counties, between 6,500 and 15,000 acres are estimated to drain to ADWs; across the rest of the state, ADWs appear to drain a total of about 5,600 acres (Table 2). The areas of the main counties drained by ADWs accounts for between 2 to 5.5% of the area of the respective counties; across the rest of the state the percentage of area drained by ADWs is 100 times less. The significantly greater numbers of ADWs and area drained within the main counties obviously suggest a significantly greater potential to affect groundwater quality in these counties, relative to their effect at the state level. But ADWs are not uniformly distributed, even within these counties, and the primary concern must be focused on the local level.

ADWs are concentrated within particular areas of the main ADW counties, in part related to the accessibility of the carbonate aquifers and because of difficulties in achieving drainage via ditches or tiles in these areas. From the registration list, one township in Wright County has about 30 ADWs, and one township in Floyd County contains 25. Two townships in Humboldt County each contain 50 ADWs, and one township in Pocahontas County has almost 60 drainage wells. A four-township region of Humboldt-Pocahontas counties contains 190 registered ADWs. This is nearly 85% of all ADWs registered in these two counties, and 43% of those registered statewide. In some individual sections (1 square mile),

**Table 2.** State and county summary of ADW data from registration reports.

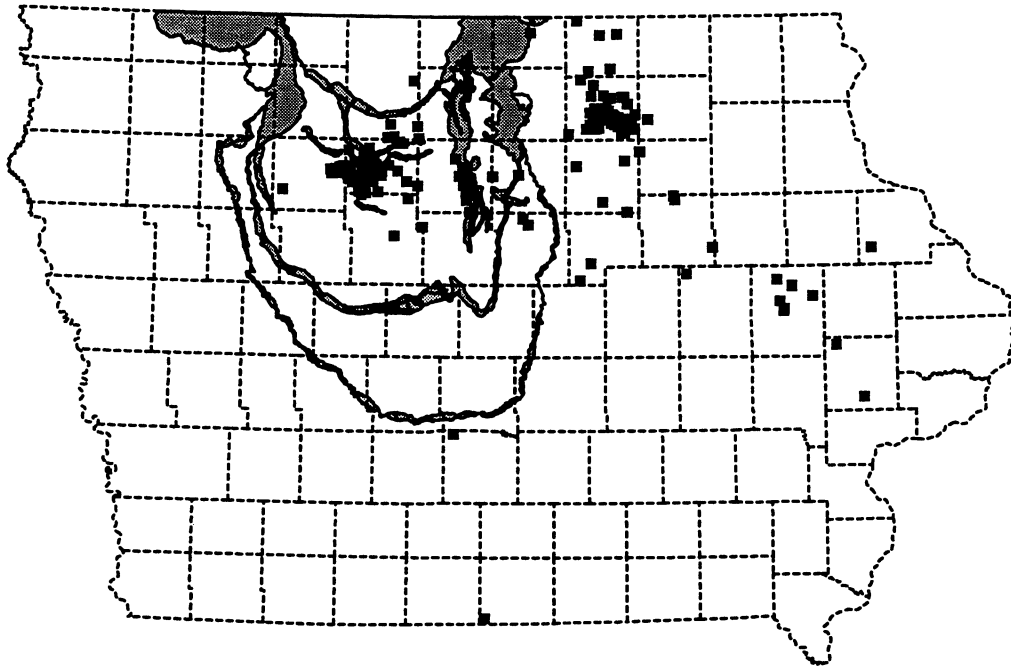
	State Total	Floyd County	Wright County	Humboldt County	Pocahontas County	Other Counties
Number of ADWs:	442	92	41	164	63	82
ADWs/sq mile:	0.008	0.2	0.08	0.36	0.12	0.001
Acres drained by ADWs:	46,750	11,500	6,550	14,500	8,600	5,600
% of land area:	0.13%	4%	2%	5%	2%	0.02%

as many as 10 ADWs appear to be present. The effect of ADWs on groundwater quality will be most profound in such areas of concentration.

### PREVIOUS INVESTIGATIONS

Musterman et al. (1981) produced an extensive review of ADWs in Iowa, and made numerical estimates of their effects within the main ADW zones of Floyd, Wright, and Humboldt-Pocahontas counties. Their calculations were based on estimates of: 1) the volume of subsurface drainage water injected via ADWs; 2) the nitrate-N concentration of the drainage water; and 3) the volume of other groundwater recharge and inflow that is available to “dilute” the inputs of ADWs. This other (natural) recharge was assumed to be free of nitrate. Table 3 summarizes the assumptions used for these estimates. Groundwater recharge was calculated using Darcy’s Law, assuming an average vertical hydraulic conductivity (K) for the glacial till units that overlie the ADW-affected bedrock aquifers. A K value of 0.002 ft/day was used for the Floyd County ADW area; 0.001 ft/day was used for the other ADW areas. Values for till thickness and vertical hydraulic gradients were extrapolated from various regional publications by DNR-GSB and the U.S. Geological Survey (e.g., Horick and Steinhilber, 1973; Hansen, 1975; 1978), and from data on-file at DNR-GSB. Complete mixing of the drainage water with nitrate-free groundwater recharge was assumed.

Musterman et al.’s calculations suggest that other groundwater recharge is sufficient to dilute the ADW inputs resulting in groundwater beneath the ADW zones having an *average* nitrate-N concentration less than the U.S. EPA Health Advisory Level (HAL; 10 mg/L nitrate-N), even under their estimate of “worst-case” conditions: 30% of precipitation becoming drainage to ADWS, with the drainage having an average nitrate-N concentration of 20 mg/L. They note that this degree of dilution would not necessarily occur locally. The assumptions used by Musterman et al. (1981) are necessarily based on regional averages and simplified assumptions, and the authors indicate that the estimates are likely accurate only to within a factor of ten. While most of their assumptions are reasonable, in some areas the assumption of nitrate-free groundwater recharge is clearly not valid. Also, there are some differences in the estimated areas drained by ADWs between Musterman et al. (1981) and this summary (see Tables 2 and 3). The greatest differences are for Floyd County where they significantly underestimated the number of ADWs, and therefore the area of the county drained, compared to the registration reports.



**Figure 2.** Map of statewide distribution of state-registered ADWs.

Baker and Austin (1984) investigated ADW effects in the area of Humboldt-Pocahontas counties. Their investigations included modeling of the quality and quantities of runoff and tile drainage that might reach typical ADWs; modeling of the effects of the ADW inputs to the groundwater system; and a three-time sampling of domestic water-supply wells within and away from concentrations of ADWs, in a variety of hydrogeologic settings with differing susceptibility to contamination (i.e., Hallberg and Hoyer, 1982). In general, Baker and Austin (1984) suggested that: 1) ADWs negatively impact groundwater, including groundwater used for drinking water supplies, within 0.6-1.2 miles (1-2 km) of clusters of ADWs; 2) not all wells located within these distances appear to be affected; and 3) the impacts were generally more significant with respect to nitrate than with respect to pesticide concentrations in drinking water wells. The authors also stressed the temporal aspects of the inputs to ADWs.

Cherryholmes and Gockel (1987) monitored the nitrate and herbicide concentration of tile drainage water entering 8 ADWs in Floyd County in June, July, and September 1986. During June and July, all 8 ADWs were receiving drainage. Nitrate-N concentrations in the influent drainage varied from 6.9 to 25.0 mg/L; all the drainage contained detectable herbicides. In June, drainage to six of the wells contained at least three of the following compounds: alachlor, atrazine, cyanazine, metribuzin, or metolachlor; drainage to the other two wells contained only atrazine. In July, five of the wells received drainage with combinations of two of the following compounds: atrazine, metribuzin, or metolachlor. Drainage to the other wells contained only atrazine or metolachlor. By September, only 3 of the ADWs were still receiving drainage. Herbicides were still present in the drainage water flowing to the three ADWs.



**Table 3.** Parameter assumptions used by Musterman et al. (1981), and resulting estimated impacts of ADWs on groundwater quality.

Parameter	Units	Floyd Co.	Wright Co.	Humboldt-Pocahontas Co.
Groundwater Recharge	acre-feet inches	39,000 6.6	34,400 2.6	68,900 3.0
Subsurface Drainage via ADWs		-----10-30% of annual precipitation----- 160 acres/well		
Area Assumed Draining to ADWs	acres	4,000	8,000	32,000
ADW Drainage as % of all groundwater recharge in ADW areas		3-8%	11-34%	9-30%
Nitrate-N concentration in drainage water	mg/L	----- 10-20mg/L -----		
Nitrate-N concentration of resultant groundwater in bedrock aquifer	mg/L	0.5-1.6	1.0-5.0	1.0-7.0

The DNR-GSB investigated ADW impacts in the Floyd County area during 1985-86 (Libra and Hallberg, 1985; Libra et al., 1994). These investigations included: 1) drilling several core penetrations of the pertinent geologic units in the area, to allow for refined hydrostratigraphic analysis of these units; 2) completing these coreholes as observation-well nests, and monitoring water levels and water quality at these; and 3) monthly monitoring of water quality, for 18 months, at private wells within and away from concentrations of ADWs, in a variety of hydrogeologic settings with differing susceptibility to contamination. Monitoring of the observation-well nests and some private wells has continued, with varying frequency.

In general, the DNR-GSB investigations concur with the conclusions of Baker and Austin (1984); while ADWs do negatively impact groundwater and drinking water within 0.5 to 1.5 miles of numerous ADWs, not all wells within this distance show ADW impacts and the apparent impacts vary with time. ADW impacts were most noticeable following runoff and/or infiltration generating conditions, when surface and/or tile drainage is delivered to the groundwater via ADWs. During extended dry periods drainage inputs are insignificant, and ADW impacts are less, or not, noticeable. These investigations also showed that ADW effects were difficult to identify in the areas where the receiving aquifer is naturally susceptible to contamination.

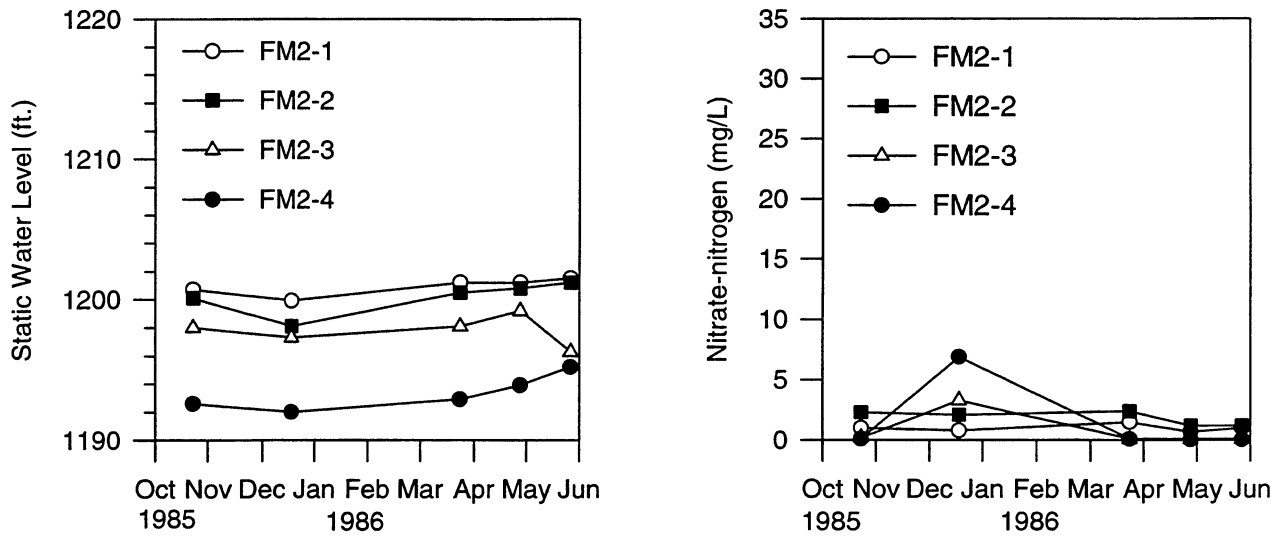
## ADWS AND GROUNDWATER QUALITY: A DETAILED LOOK

An example of the effects that ADWs can have on groundwater is illustrated in data from two DNR-GSB observation-well nests. One of these nests is located in Floyd County and the other in neighboring Mitchell County. The sites are located in similar hydrogeologic settings — with 40 to 60 feet of low-permeability Quaternary materials overlying Devonian carbonate aquifers. Contamination from surficial sources through natural, direct vertical recharge is limited to non-existent in such a setting (see Libra et al., 1984). Both well nests contain four bedrock wells that are finished in comparable positions within the vertical thickness and stratigraphic framework of the Devonian aquifers. Well nest FM2 is located in Mitchell County, removed from registered or otherwise known ADWs. Well nest FM3 is located in Floyd County, within one mile of at least five ADWs; the closest is about 500 feet away and approximately 300 feet deep. The other ADWs are more shallow, approximately 60 - 70 feet deep. These observation wells were typically monitored on a monthly to quarterly basis from February 1985 through June 1986, and again from October 1988 through October 1992. Figures 3 and 4 show groundwater levels and nitrate-N concentrations for well nests FM2 and FM3, respectively, for the period October 1985 through June 1986.

Of particular interest are the hydrologic and water quality responses of the well nests during March 1986, when significant snow melt, accompanied by heavy rains, occurred during a 2-3 day period. This recharge had little short-term effect at well nest FM2, as the relatively thick cover of aquitard materials limits recharge inputs of water and chemicals to the underlying aquifers. In contrast, groundwater elevations at nest FM3 show a rapid rise; direct field observations indicated that much of the rise occurred while the recharge event was occurring. During this time, relatively large volumes of tile drainage water were observed entering the nearest drainage well and the water level in the drainage well rose above the land surface. The rise in water levels at FM3 was a result of the inputs to this and other local drainage wells. Significant increases in nitrate-N concentrations occurred in some, but not all of the bedrock research-wells in this nest. During dry periods prior to this recharge event, nitrate-N concentrations were typically less than 1 mg/L and always below 3 mg/L. During the event, samples were collected from the wells twice, three days apart. The highest concentration measured in the shallowest well was 30 mg/L nitrate-N, 3 times the U.S. EPA HAL, and the herbicide atrazine was also detected. There was no chemical response noted in the two wells of intermediate depth, although samples collected during other relatively wet periods have contained detectable nitrate-N.

Nitrate-N concentrations in the deepest well rose to 4 mg/L, but no herbicides were present. Drainage entering the nearest ADW, over 300 feet deep (similar to the deepest monitoring well), contained 12 mg/L nitrate-N and also no herbicides. While the nearest ADW appears to have delivered the nitrate-N (and no herbicides) to the deepest well, drainage to the ADW had a lower nitrate-N concentration than observed in the most shallow monitoring well. This suggests inputs from the other, more shallow ADWs nearby, impacted the shallowest well at FM3.

Another recharge event occurred in late May 1986, and provides further insights. Drainage to the deep ADW nearest FM3 contained 14 mg/L nitrate-N, 3 µg/L cyanazine, and 6 µg/L metolachlor. Groundwater from the deepest research well at FM3 contained 6 mg/L nitrate-N, 0.4 µg/L cyanazine, and 0.9 µg/L metolachlor. The shallowest well produced water with 17 mg/L nitrate-N, but no herbicides. The nearest ADW again appears to have directly affected the similar depth monitoring well, while the shallowest well must be affected by another ADW(s). Note that when dry conditions occurred again, and drainage inputs were



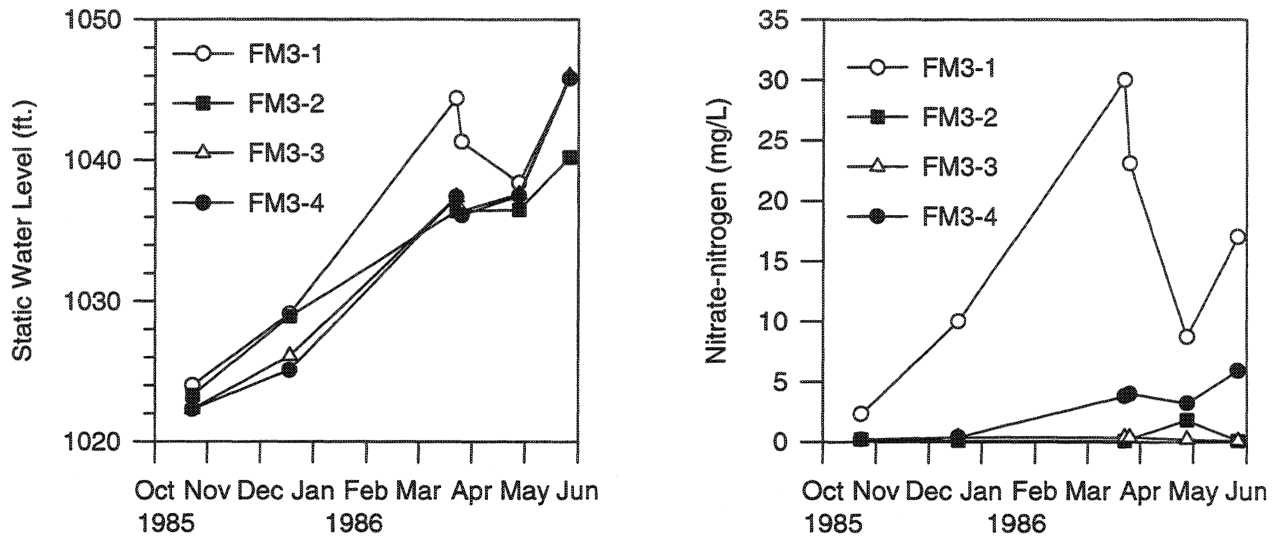
**Figure 3.** Potentiometric elevations and nitrate-N concentrations at well nest FM-2. Open intervals of the observation wells are FM2-1, 60-70 feet; FM2-2, 110-150 feet; FM2-3, 190-250 feet; and FM2-4, 280-340 feet.

minimal, nitrate-N concentrations from water in these wells returned to less than 3 mg/L, and herbicide concentrations dropped below detection limits. During the period FM3 was monitored (1985-1986 and 1988-1992), the highest nitrate-N concentrations measured at the FM3 wells were, from the shallowest to deepest, 54 mg/L, 1.8 mg/L, 7.2 mg/L, and 8.5 mg/L, respectively. Many of the private wells in the area are approximately in the same range of depths as the two shallowest wells at FM3. Therefore, the data from this well nest illustrates the type of effects ADW inputs may have on local drinking-water wells. The groundwater record from these monitoring wells illustrates that the impact from ADWs over time is punctuated by rapid hydrologic and chemical responses during periods of significant ADW recharge, and that the effects dissipate between these periods.

In December 1994, the three ADWs closest to well nest FM3 were closed. DNR-GSB is currently monitoring FM3 and a number of private wells in the immediate area, to assess the groundwater-quality improvements that result from closing ADWs. Preliminary results show concentrations of nitrate-N and pesticides to have declined in response (Quade, 1995).

### ADWS IN WRIGHT COUNTY

Figure 5 is a map for Wright County, showing the thickness of Quaternary deposits, the location of state-registered ADWs and hog confinement facilities, and former ice margins of the Des Moines Lobe. Most of the ADWs in Wright County are located in three townships. This area is located on an upland plain characterized by low relief with a few diffuse circular ridges. This upland plain contains soils of the Brownton-Ottosen-Bode Association. These soils are heavy textured, very gently sloping to level, and are developed in lacustrine sediments (Lake Mills Mbr. of the Dows Formation; 0.5 - 2m thick) over undifferentiated diamicton of the Dows Formation (Kemmis et al., 1981). This low relief, poorly drained area of lacustrine sediments marks the location of Glacial Lake Wright (Kemmis, 1991). This lake



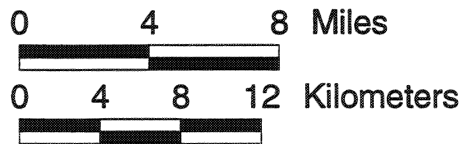
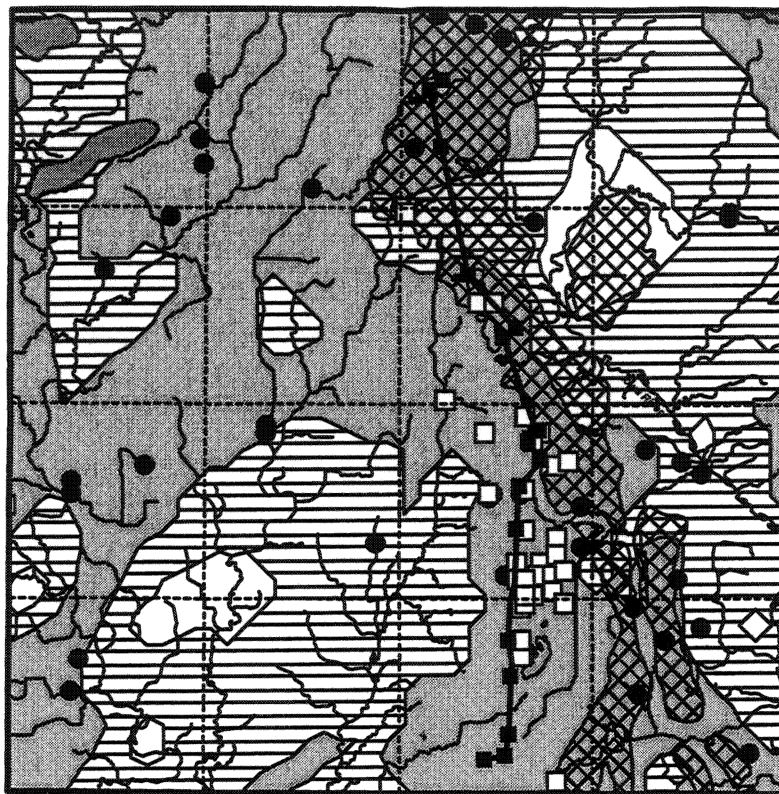
**Figure 4.** Potentiometric elevations and nitrate-N concentrations at well nest FM-3. Open intervals of the observation wells are FM3-1, 95-110 feet; FM3-2, 170-210 feet; FM3-3, 260-305 feet; and FM3-4, 350-365 feet.

plain is bounded on the east (Highway 69) by a ridge that forms the backslope of the Altamont Moraine. In this area the Altamont Moraine is a non-hummocky moderate relief ridge system (NRS) characterized by circular and irregular ridges with smooth, long slopes dissected by streams. The upland ridges are composed of a complex assemblage of thick resedimented diamictons and associated sorted sediments of the Morgan Member.





Wright County is underlain by Mississippian-age bedrock, predominantly carbonates, which is the aquifer used by most rural residents and many small municipalities. The Mississippian carbonates include the Gilmore City and Maynes Creek Formations (Woodson and Bunker, 1989). These strata, where not thinned by erosion, are about 150 and 125 feet thick, respectively. There are no regionally extensive confining beds within this rock sequence. Figure 6 is a north-south cross-section through Wright County; the line of section is shown on Figure 5. As is shown on the cross-section, erosion has significantly thinned the Gilmore City Formation; across much of the area there is less than 50 feet of the Gilmore City remaining. Erosion has had less effect to the south, where the full thickness of the formation is preserved. Locally, complete removal of the Gilmore City has occurred, and the Maynes Creek Formation is the uppermost Mississippian bedrock encountered.




Wright County is predominantly a deep bedrock area, using the terminology of Hallberg and Hoyer (1982). Bedrock is less than 50 feet from the surface in only about 5% of the county. Across 45% of the county, bedrock lies 50 to 100 feet below the surface, and is deeper than 100 feet over the remaining 50% of the county. Over 100 feet of Quaternary deposits—predominantly Des Moines Lobe materials—overlay the bedrock aquifer in the part of the county where most ADWs are located. The Mississippian aquifer in Wright County is therefore largely protected from surficial contamination that is delivered by natural processes.

Recharge to the groundwater system occurs in the upland area where most ADWs are located. Flow is directed downward through the relatively thick glacial deposits and into the



Depth to Bedrock in Feet

-  0 - 50
-  50 - 100
-  100 - 200
-  Altamont Complex Ice Margin

-  Agricultural Drainage Wells
-  Permitted EMS Sites
-  North-south geologic cross section

**Figure 5.** Modified version of the Groundwater Vulnerability Regions of Iowa map (Hallberg and Hoyer, 1991) for Wright County, showing the depth to bedrock (or thickness of aquitard cover). State-registered ADWs are also shown. North-south line locates the cross-section shown on Figure 6.

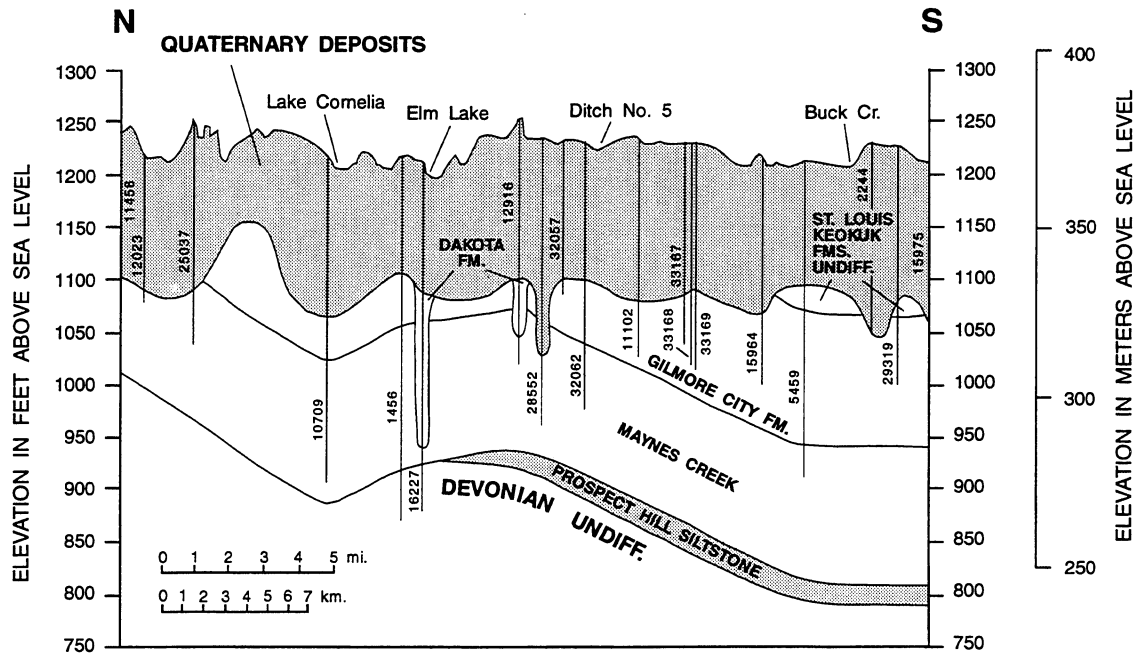
Mississippian aquifer. Existing potentiometric maps for the Mississippian aquifer in north-central Iowa (Horick and Steinhilber, 1973; Buchmiller et al., 1985) do not clearly indicate lateral groundwater-flow directions in Wright County, and suggest little groundwater flow is directed towards nearby stream discharge zones. While the Iowa River potentially is a discharge area for the aquifer in the county, upward groundwater flow from the aquifer to the river is impeded by the relatively thick cover of glacial deposits present beneath the valley, and lateral groundwater flow is therefore not directed towards the river. Base-flow indexing (Gustard et al., 1992) suggests groundwater recharge in the area is about 3.2 inches. Musterman et al. (1981) estimated recharge at 2.6 inches/year.

State-registered ADWs are shown on Figure 5. The merged state-federal registration list suggests there are 41 ADWs in the county. Extrapolating the reported acreage drained for these ADWs to all those on the merged list suggests about 6,550 acres of Wright County drain to ADWs; this accounts for 1.9% of the county. Data from the U.S. EPA and IDALS suggest that a third of the ADWs located in fields in Wright County have surface-water intakes. Depths were reported for only 17 of the ADWs and these are summarized in Table 4. Only 12% of the reported depths are less than 100 feet, a result of the thick cover of glacial deposits in this area. About 35% are in the 100- to 199-foot range, while 47% are 200 to 299 feet deep. The remaining ADW representing 6% of the reported depths, is about 300 feet deep. Extrapolating to the merged registration list suggests there are 5 ADWs less than 100 feet deep in the county, about 14 ADWs in the 100- to 199-foot range, and 20 in the 200- to 299-foot range. Two wells may exceed 300 feet. Stratigraphically, 65% of the ADWs in Wright County bottom in the Gilmore City Formation, and 53% of all the ADWs bottom less than 100 feet above the top of the underlying Maynes Creek Formation. The remaining 35% end within the Maynes Creek, with 29% bottoming 70 to 90 feet above the base of the Maynes Creek. There hasn't been an investigation of the water quality effects of ADWs in Wright County. However, the effects are anticipated to be similar to those described by Baker and Austin (1984) for Humboldt and Pocahontas counties, and by Libra et al. (1994) for Floyd County.

## MITIGATING THE WATER-QUALITY IMPACT OF ADWS

Lemke et al. (1995) present an evaluation of the effects of closing ADWs. Closure of 225 ADWs, and their replacement with alternative drainage to surface water, is estimated to cost \$22 million; costs per ADW range from \$12,000 to \$390,000; costs per acre vary from \$128 to \$847. If ADWs were closed and alternate drainage is not supplied, about one-third of the acres drained by ADWs state-wide would be removed from row-crop production. Lemke et al. (1995) also investigated possible options for continuing the use of ADWs but with methods to mitigate water-quality impacts. These include removing surface water intakes from drainage systems, and therefore decreasing the inputs of herbicides, biological contaminants, and sediment to ADWs; and refined management of chemical inputs to fields drained by ADWs.

As an applied example of refined chemical management, Integrated Crop Management (ICM) was introduced by ISU-Extension to selected "clusters" of agricultural drainage well (ADW) owners and users in the fall of 1994 (Rieck-Hinz, 1996). During crop year 1995 a total of 14 cooperators farming 3,844 acres were served by project staff. This project is targeting producers who may be subject to state administrative rules regarding the continued use of ADWs. The participants volunteer to enroll in the project. No compliance or regulatory rules



**Figure 6.** North-south geologic cross section across Wright County. Aquitard units are shaded. Location of cross-section transect is shown on Figure 5.

are in effect at this time. The project was initially funded by the Integrated Farm Management Demonstration Program of the Agricultural Energy Management Fund through the Iowa Department of Agriculture and Land Stewardship. Beginning in fiscal year 1996 the project will be funded by U.S. EPA Section 319(h) funds.

ICM is an intensive planning process that allows producers to enhance crop management practices while protecting and sustaining natural resources and increasing production efficiency and profitability (Brown et al., 1994). The primary concern of the enrolled cooperators was to implement practices that would allow them to maintain their eligibility for continued use of the ADWs. Although specific management practices addressing acres drained by ADWs are yet to be promulgated by state administrative rules, it is known that nitrogen and pesticide management will be emphasized.

Nitrogen management through the ICM program will be evaluated for each cooperator on a field-by-field basis. Nitrogen recommendations will be based on the soil resource, realistic yield goals, nitrogen credit for legumes in the crop rotation, and nitrogen credit for animal manure applications. In addition to nitrogen credits, nitrogen management will be refined using tools such as the late spring nitrate test and the end of season cornstalk test as appropriate. Based on findings at the ADW research farm near Gilmore City, cooperators will be advised on the potential for additional nitrogen loss through split applications of nitrogen, and their cropping practices will be evaluated based on this information. In addition, cooperators will be advised of the setback requirements for manure applications according to the manure management requirements for ADW owner/users.

**Table 4.** Distribution of ADW depths in Wright County from registration reports.

Depth Range	%	Cumulative %
<100 ft	12%	12%
100-199 ft	35%	47%
200-299 ft	47%	94%
>300 ft	6%	100%

Chemical (herbicide) management through the ICM program will be evaluated for each cooperator on a field-by-field basis determined by cropping practices and crop monitoring. Recommendations for chemical management include timelines, reduced rates, banding, and spot spraying if applicable. In some cases refinements may require rates to be increased to assure effectiveness. In addition, recommendations for changes in cultural practices will be made if applicable. ADW owner/user cooperators will be advised of herbicides that have been detected in studies at the ADW research farm near Gilmore City. Based on these results, producers planning to utilize any of the detected products will be advised to consider alternative weed management practices including chemical and non-chemical refinements, as appropriate.

Currently there are four cluster areas in the ICM project for ADWs; one in Pocahontas County, two in Humboldt County, and one in Wright County. The Pocahontas cluster has 8 cooperators enrolled with 1,349 acres and 11 ADWs. The Humboldt clusters include 10 cooperators with 4,635 acres and 16 ADWs. The Wright cluster has 4 cooperators enrolled with 760 acres and 3 ADWs. It is anticipated that enrollment in the ICM project will continue through the first quarter of fiscal year 1996.

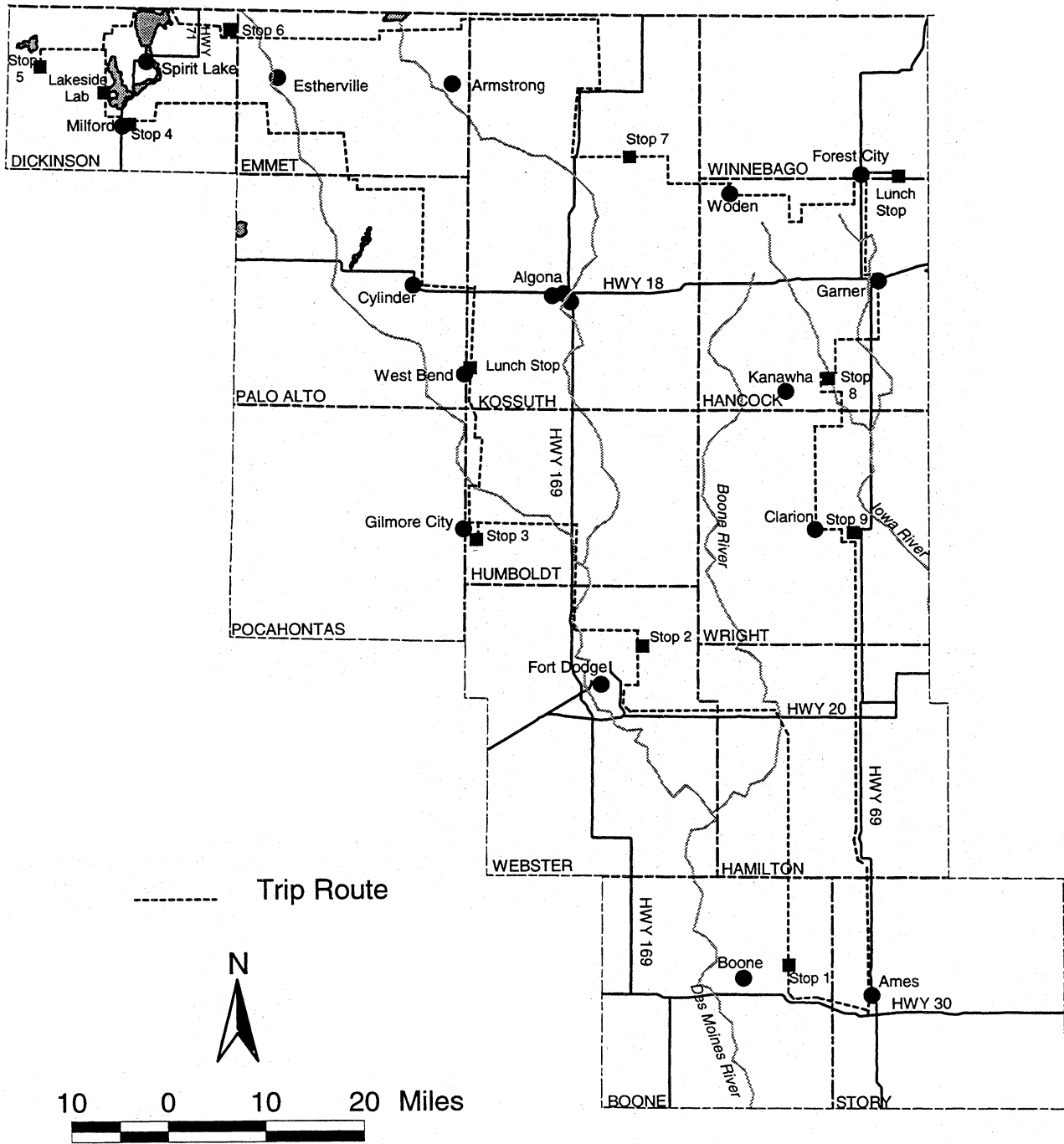




## REFERENCES

- Baker, J.L. and Austin, T. A., 1984, Impact of agricultural drainage wells on groundwater quality: U.S.EPA Contract Report #G007228010, ISU-ERI-Ames-85183, 238 p.
- Baker, J.L., Kanwar, R.S., and Austin, T. A., 1985, Impact of agricultural drainage wells on groundwater quality: *Journal of Soil and Water Conservation*, v. 40, p. 516-520.
- Baker, J.L., Melvin, S.W., and Lemke, D.W., 1996, Possible groundwater contamination from use of agricultural drainage wells, *in* Proceedings, Agriculture and Environment-Building Local Partnerships, Iowa State University, Ames, IA, p. 2.33-2.41.
- Brown, S.S., Connelly, K.A., and Miller, G.A., 1994, Handbook for integrated crop management: Iowa State University Extension, MFD-5.
- Buchmiller, R., Gaillet, G., and Soenksen, P. J., 1985, Water resources of north-central Iowa: Iowa Geological Survey Water Atlas #7, 93 p.
- Cherryholmes, K. L., and Gockel, M. L., 1987, Iowa agricultural drainage well assessment report: U.S.EPA, Contract Report #G007273010, University Hygienic Laboratory, Iowa City, IA, 26 p.
- Gustard, A., Bullock, A., and Dixon, J.M., 1992, Low flow estimation in the United Kingdom: Institute of Hydrology Report #108, Institute of Hydrology, Wallingford, Oxon, Great Britain, 88 p.
- Hallberg, G. R., and Hoyer, B. E., 1982, Sinkholes, hydrogeology, and groundwater quality in northeast Iowa: Iowa Geological Survey Contract Report #81-5500-04, 120 p.
- Hallberg G.R., and Hoyer, B.E., 1991, Groundwater vulnerability regions of Iowa: Iowa Department of Natural Resources, Geological Survey Bureau, Special Map Series II.
- Hallberg, G.R., Baker, J.L., and Randall, G.W., 1986, Utility of tile-effluent studies to evaluate the impact of agricultural practices on ground water, *in* Proceedings, Agricultural Impacts on Ground Water, National Water Well Association, p. 298-328.
- Hallberg, G. R., Kross, B. C., Libra, R. D., Burmeister, L. F., Weih, L. M. B., et al., 1990, The Iowa state-wide rural well-water survey: design report: a systematic survey of drinking water quality: Iowa Department of Natural Resources, Geological Survey Bureau, Technical Information Series 17, 135 p.
- Hansen, R. E., 1975, Bedrock topography of northeast Iowa: U. S. Geological Survey Map I-933.
- Hansen, R. E., 1978, Bedrock topography of north-central Iowa: U. S. Geological Survey Map I-1080.
- Horick, P. J. and Steinhilber, W. L., 1973, Mississippian aquifer of Iowa: Iowa Geological Survey, Miscellaneous Map Series 3.
- Iowa Department of Agriculture and Land Stewardship, 1994, Agricultural drainage well research and demonstration project: Annual Report, 1994, Iowa Department of Agriculture and Land Stewardship and Iowa State University, 64 p.
- Kemmis, T.J. Hallberg, G.R. and Lutenegger, A.J., 1981, Depositional environments of glacial sediments and landforms on the Des Moines Lobe, Iowa: Iowa Geological Survey Guidebook No. 6, Iowa City, 132 p.
- Kemmis, T.J., 1991, Glacial landforms, sedimentology and depositional environments of the Des Moines Lobe, Northern Iowa: University of Iowa Department of Geology, Iowa City, unpublished Ph.D. thesis, 393 p.
- Kross, B. C., Hallberg, G. R., Bruner, D. R., Libra, R. D., Rex, K. D. et al., 1990, The Iowa state-wide rural well-water survey water quality data: initial analysis: Iowa Department Natural Resources, Geological Survey Bureau, Technical Information Series 19, 142 p.
- Lemke, D.W., Baker, J.L., Melvin, S.W., Lawlor, P.A., and Heinen, B.W., 1995, Development of best management practices for agricultural drainage wells in Iowa, *in* Proceedings, Annual Underground Injection Control and Ground Water Protection Forum: Ground Water Protection Forum, Kansas City, MO, p.199-212.
- Libra, R. D., Hallberg, G. R., Ressmeyer, G. G., and Hoyer, B. E., 1984, 1. Groundwater quality and hydrogeology of Devonian-carbonate aquifers in Floyd and Mitchell counties, Iowa: Iowa Geological Survey, Open File Report 84-2, p. 1-106.
- Libra, R. D. and Hallberg, G. R., 1985, 1. Hydrogeologic observations from multiple core holes and piezometers in the Devonian-carbonate aquifers in Floyd and Mitchell counties, Iowa: Iowa Geological Survey, Open File Report 85-2, p. 1-19.
- Libra, R. D., and Hallberg, G. R., 1993, Agricultural drainage wells in Iowa: Hydrogeologic settings and water-quality implications: Iowa Department of

- Natural Resources, Geological Survey Bureau, Technical Information Series 24, 39 p.
- Libra, R.D., Hallberg, G.R., Quade, D.J., and Littke, J. P., 1994, Groundwater quality, hydrogeology, and agricultural drainage wells, Floyd and Mitchell counties, Iowa: Iowa Department of Natural Resources-Geological Survey Bureau Technical Information Series 29, 64 p.
- Musterman, J. L., Fisher, R. A., and Drake, L., 1981, Underground injection control in Iowa: U.S. EPA Contract Report G007165 01.
- Quade, D.J., 1995, Monitoring of a piezometer nest and nearby private wells in an ADW closure area, Floyd County, Iowa: Geological Society of Iowa, Guidebook 62, p. 85-111.
- Rieck-Hinz, A., 1996, Implementation of an integrated crop management program to address water quality concerns in agricultural drainage areas, *in* Proceedings, Agriculture and Environment-Building Local Partnerships, Iowa State University, Ames, IA, p. 4.29-4.32.
- Woodson, F. J. and Bunker, B. J., 1989, Lithostratigraphic framework of Kinderhookian and early Osagean (Mississippian) strata, north-central Iowa, *in* Woodson, F. J. (ed.), An Excursion to the Historic Gilmore City Quarries: Geological Society of Iowa, Guidebook 50, p. 3-18.



**Iowa Department of Natural Resources**  
 Energy and Geological Resources Division  
 Geological Survey Bureau  
 109 Trowbridge Hall  
 Iowa City, Iowa 52242-1319  
 (319) 335-1575